









-  气囊
-  气体发生器
-  安全带预紧器
-  SRS 控制单元
-  主动行人保护系统
-  气体压力缓冲器/预压紧的弹簧
-  低电压蓄电池
-  汽油 燃料罐

提示: 详细信息请参见[救援指南](#)。



1. 确认/识别

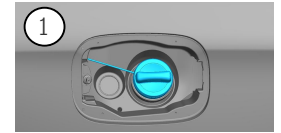

2. 固定/稳定/抬升

手刹

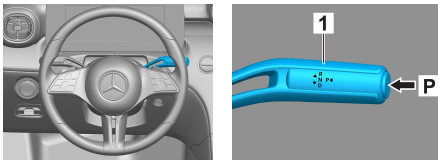

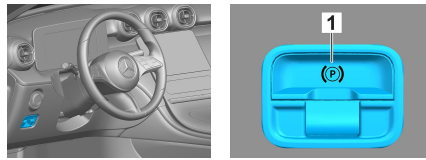

驻车制动器

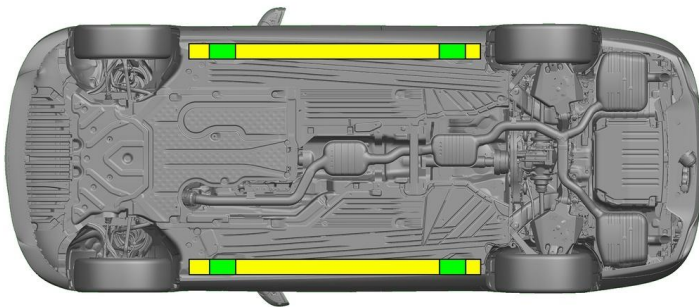

按下换挡杆 (1) 上的开关 P。自动激活手刹。

电动驻车制动器 (1)



 适当的提升点

 侧面上适当的稳定点



救援期间必须避免车门门槛结构和车身底板发生额外的变形（例如用千斤顶撑住）。

3. 消除威胁/安全规章

关闭点火装置：

1. 按下启停按钮，而不要操作行车制动器。
2. 将电子车钥匙放在至少 5 米以外。

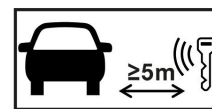

发动机没有发出声音，并不意味着车辆就已经熄火了。



在车辆熄火之前均可重启。



断开 12V/48V 电池连接

1. 取掉发动机舱中的 12V/48V 电池的盖板。
2. 松开螺栓连接上 12V/48V 电池的负极电缆，并将其固定好，防止无意接触。





断开 12/48V 电池连接



1. 取掉行李厢中的 12/48V 电池的盖板。
2. 松开螺栓连接上 12/48V 电池的负极电缆，并将其固定好，防止无意接触。



停用无源安全系统（安全气囊和安全带拉紧器）。

4. 救援通道搭建

解救车辆驾驶员及乘客时应根据第 1 页上的说明考虑到约束系统的部件（尤其是爆燃元件）。

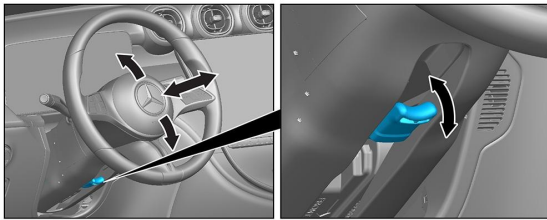

方向盘调节

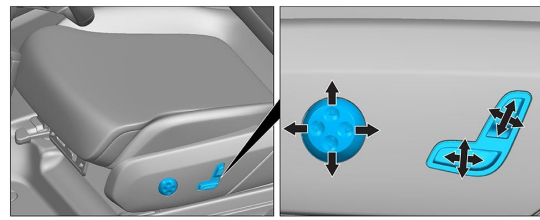

座椅调节（电动）

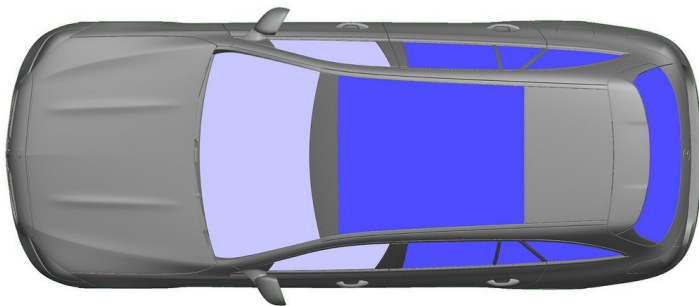

- VSG：夹层安全玻璃
- ESG：单层安全玻璃

5. 剩余电量 / 液化气 / 燃油 / 固体燃料

						12/48V
						66L
						570 ± 10g

6. 车辆起火



使用大量的水 (H₂O) 灭火。

7. 车辆淹没

没有车身通电的危险。打捞车辆后：

1. 把水从汽车内室中排出。
2. 停用 12V/48V 车载电气系统（参见第 3 章）。



8. 牵引/转移/存放

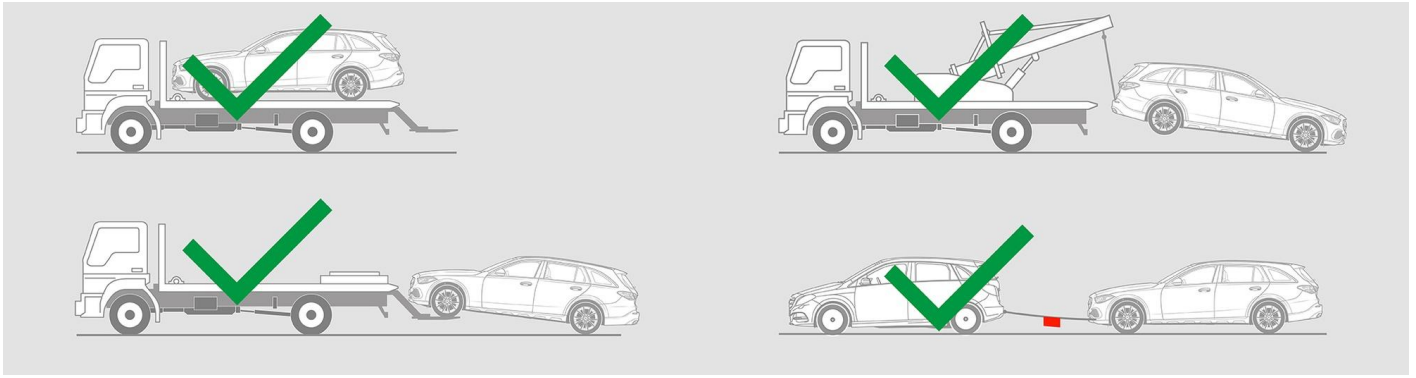

9. 其他重要信息

更多信息请查看 [乘用车拖车服务指南](#)。

10. 使用图示的释义

- | | | | |
|---|--|--|---|
|  使用第 2 组液体燃料的汽车 |  一般警告标志 |  易燃 |  对人体健康有害 |
|  腐蚀性物质 |  急性毒性 |  易爆 |  用水灭火 |
|  用干泡沫灭火 |  用湿泡沫灭火 |  发动机罩 |  行李舱 |
|  移除智能钥匙 |  空调系统组件 |  警告, 低温 | |