

提示: 详细信息请参见[救援指南](#)。

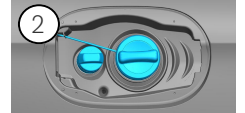

1. 确认/识别

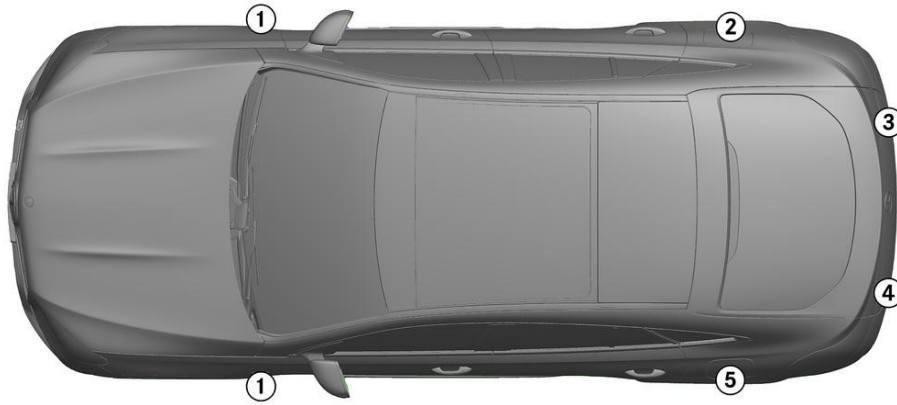

2. 固定/稳定/抬升

手刹

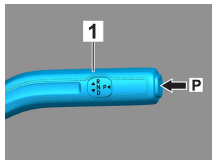

驻车制动器

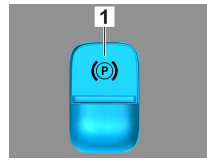
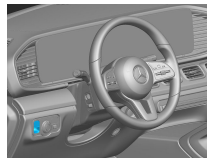

按下选挡杆 (1) 上的开关 P。自动激活手刹。

电动驻车制动器 (1)

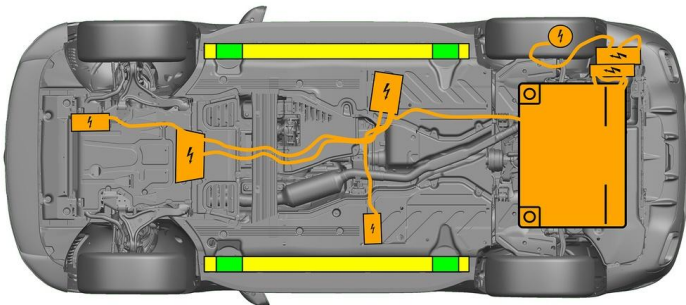

- 适当的提升点
- 侧面上适当的稳定点
- 高压电池



救援期间必须避免车门门槛结构和车身底板发生额外的变形（例如用千斤顶撑住）。

3. 消除威胁/安全规章

关闭点火装置：

1. 按下启停按钮，而不要操作行车制动器。
2. 将电子车钥匙放在至少 5 米以外。

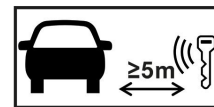

发动机没有发出声音，并不意味着车辆就已经熄火了。



在车辆熄火之前均可重启。

停用高压系统



若是事故发生时触发了安全气囊和安全带拉紧器，将会自动关闭高压系统。





而在其他情况下，如下停用高压系统：

选项 1: 高压断开装置

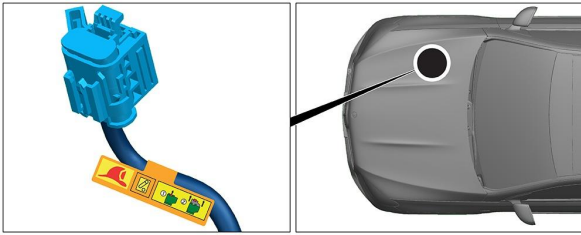

高压断开装置位于 副驾驶侧的发动机舱内。

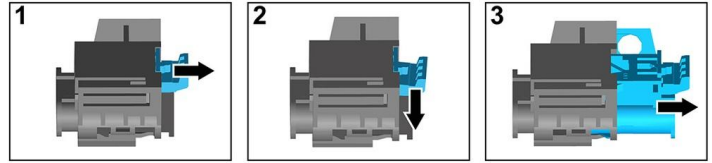

- (1) 拉动解锁装置
- (2) 向下按下解锁装置
- (3) 拉出开关



选项 2: 备用高压断开装置

备用高压断开装置位于驾驶员侧驾驶舱的保险丝盒盖板下方。
备用高压断开装置用指示牌标记。

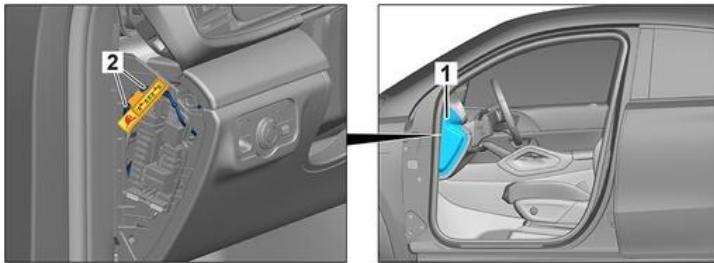

取掉盖板 (1)。在标记点 (2) 处切断电线。



为确保高压电网中不再有残余电压，关闭后等待大约 20 秒。



安全气囊和安全带拉紧器等无源安全系统将 继续由 12V 车载电气系统供电。



断开 12V 电池连接

1. 取掉 12V 电池的盖板
2. 松开螺栓连接上 12V 电池的负极电缆，并将其固定好，防止无意接触。



停用无源安全系统（安全气囊和 安全带拉紧器）。



4. 救援通道搭建

解救车辆驾驶员及乘客时应根据第 1 页上的说明考虑到约束系统的部件（尤其是爆燃元件）。

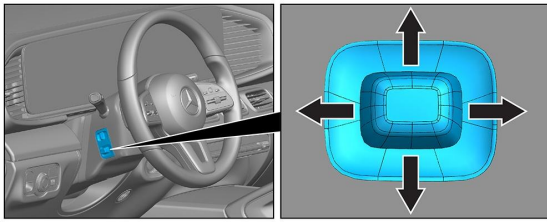

方向盘调节

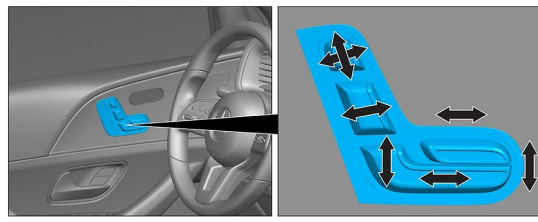

座椅调节（电动）

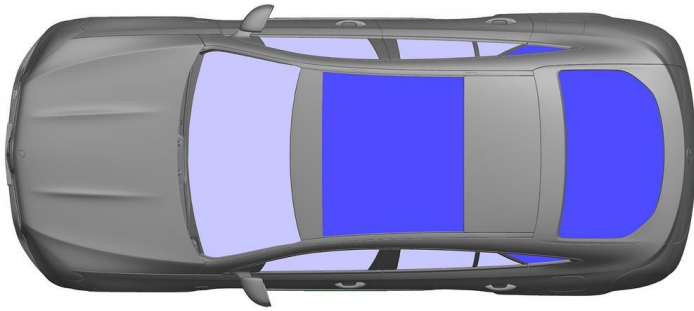

VSG：夹层安全玻璃

ESG：单层安全玻璃

5. 剩余电量 / 液化气 / 燃油 / 固体燃料

	 	12V
	 	400V
	 	65L
	 	700 ± 10g



所有高压电缆都装设有橘黄色的绝缘层。

6. 车辆起火



使用大量的水 (H₂O) 灭火。
使用大量的水 (H₂O) 冷却锂离子电池。



警告：电池重新点燃。



如果冷却液从高压电池中漏出，由于热过载，冷却液可能变得不稳定。用红外热像仪检查电池温度。



7. 车辆淹没

没有车身通电的危险。

打捞车辆后：

1. 把水从汽车内室中排出。
2. 停用高压系统（参见第 3 章）。



8. 牵引/转移/存放

运输车辆时，车辆的双轴都必须处在拖车或车辆运输车上。

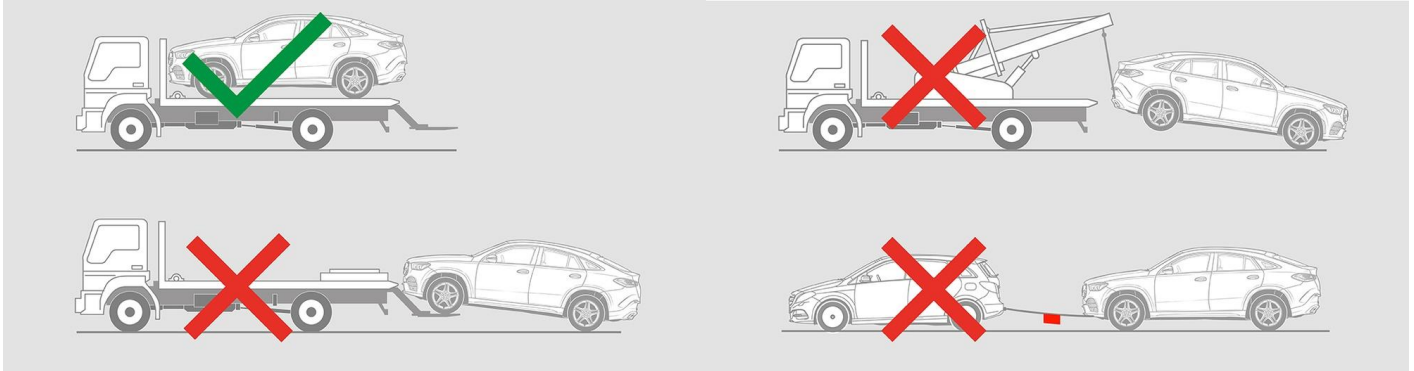

与其他车辆保持安全距离。



警告：电池重新点燃。



9. 其他重要信息

更多信息请查看 [乘用车拖车服务指南](#)。

10. 使用图示的释义



使用第 1 组液体燃料的混合动力汽车



一般警告标志



警告，电力



易燃



对人体健康有害



腐蚀性物质



急性毒性



易爆



用水灭火



使用热红外摄像机



发动机罩



移除智能钥匙



空调系统组件



警告，低温