

-  气囊
-  气体发生器
-  安全带预紧器
-  SRS 控制单元
-  气体压力缓冲器/预压紧的弹簧
-  低电压蓄电池
-  汽油 燃料罐

提示: 详细信息请参见[救援指南](#)。



1. 确认/识别



2. 固定/稳定/抬升

手刹

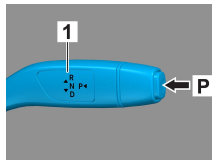

驻车制动器

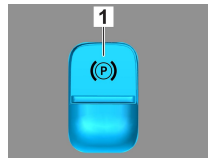
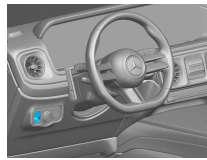

按下换挡杆 (1) 上的开关 P。自动激活手刹。

电动驻车制动器 (1)

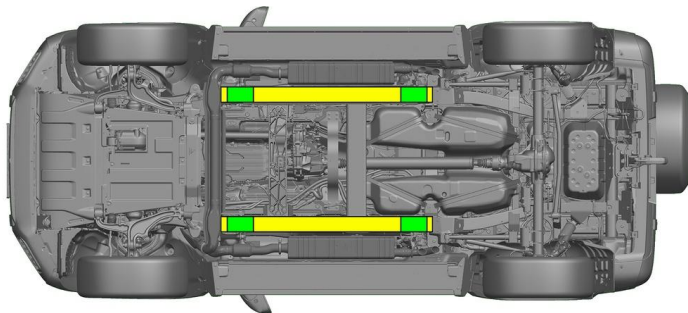

 适当的提升点

 侧面上适当的稳定点



救援期间必须避免车门门槛结构和车身底板发生额外的变形 (例如用千斤顶撑住)。

3. 消除威胁/安全规章

关闭点火装置：

1. 按下启停按钮，而不要操作行车制动器。
2. 将电子车钥匙放在至少 5 米以外。

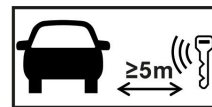

发动机没有发出声音，并不意味着车辆就已经熄火了。



在车辆熄火之前均可重启。



断开 48V 蓄电池

1. 拆卸行李箱接地板 (拧下 4 个捆扎环)，然后 拆卸各饰板 (C 柱、D 柱、腰线等) 和侧壁饰板，以接触到 48 伏蓄电池。
2. 松开 48V 蓄电池负极电缆的螺栓连接并避免意外接触。





断开 12 V 蓄电池

1. 为接触到 12 V 蓄电池, 拆卸行李箱接地平板 (拧下 4 个捆扎环)。
2. 松开 12 V 蓄电池负极电缆的螺栓连接并避免意外接触。



停用无源安全系统 (安全气囊和安全带拉紧器)。

4. 救援通道搭建

在救出乘客时, 应按照规定第 1 页的规定, 考虑由高强度钢制成的车身区域和约束系统的部件 (特别是烟火元件)。

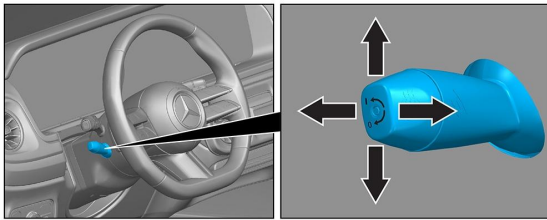

方向盘调节

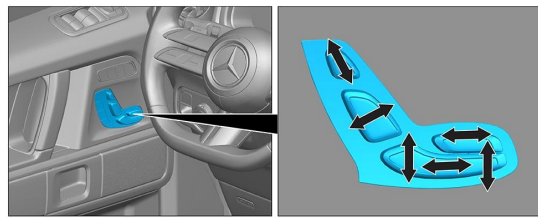

座椅调节 (电动)



- VSG: 夹层安全玻璃
- ESG: 单层安全玻璃

5. 剩余电量 / 液化气 / 燃油 / 固体燃料

		12/48V
		100L
		680 ± 10g

6. 车辆起火



使用大量的水 (H₂O) 灭火。

7. 车辆淹没

没有车身通电的危险。打捞车辆后:

1. 把水从汽车内室中排出。
2. 停用 12V/48V 车载电气系统 (参见第 3 章)。



8. 牵引/转移/存放

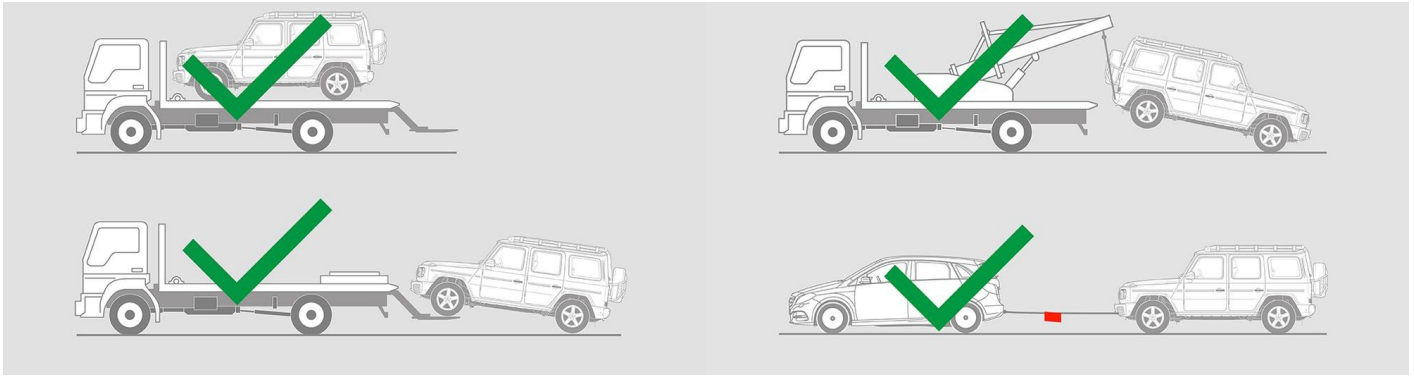

9. 其他重要信息

更多信息请查看 [乘用车拖车服务指南](#)。

10. 使用图示的释义



使用第 2 组液体燃料的汽车



一般警告标志



易燃



对人体健康有害



腐蚀性物质



易爆



用水灭火



用干泡沫灭火



用湿泡沫灭火



行李舱



移除智能钥匙



空调系统组件



警告，低温