

- |  |                    |  |                    |  |                    |  |                    |  |   |
|--|--------------------|--|--------------------|--|--------------------|--|--------------------|--|---|
|  | Hava yastığı       |  | Gaz jeneratörü     |  | Kemer gerdiriciler |  | SRS kumanda kutusu |  | Gaz basınçlı amortisör/Ön gerilimli yay |
|  | Alçak voltajlı akü |  | Dizel yakıt deposu |  |                    |  |                    |  |   |

Not: Daha fazla bilgi için lütfen [Kurtarma Kılavuzu](#)'muza bakınız.

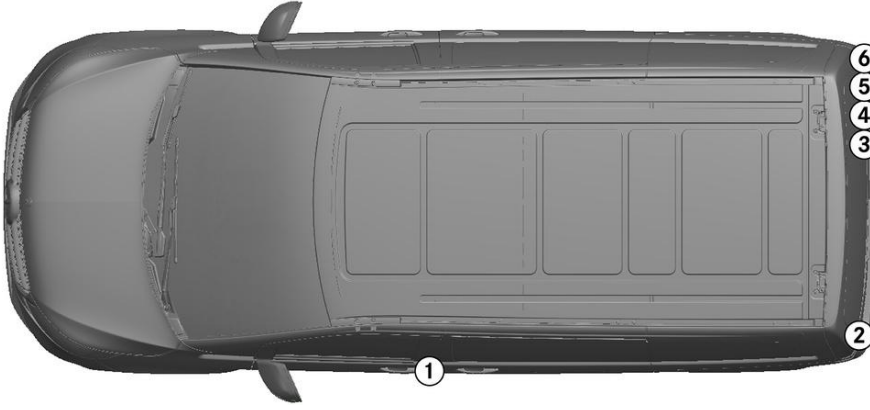

## 1. Araç tanımı / tanımlama



## 2. İşletimden alma / stabilizasyon / kaldırma

### Park freni

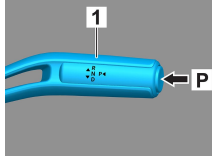

### Sabitleştirici fren

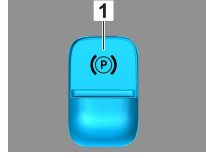

Vites seçme kolundaki (1) P şalterine basın. Park freni otomatik olarak etkinleştirilir. Elektrikli sabitleştirici fren (1)

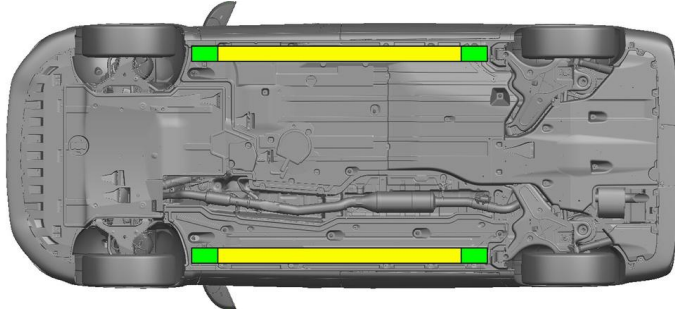

- Uygun kaldırma noktaları
- Yanda bulunan uygun stabilizasyon noktaları



Kurtarma sırasında eşiklerin ve gövde altının ek deformasyonunun (örneğin hidrolik ekipmanla desteklenerek) önüne geçilmesi gerekir.

## 3. Doğrudan tehlikelerin ortadan kaldırılması / güvenlik düzenlemeleri

### Kontağın kapatılması:

- İşletim frenini etkinleştirmeden BAŞLAT-DURDUR (START-STOP) tuşuna basın.
- Elektronik araç anahtarını en az 5 m mesafede tutun.

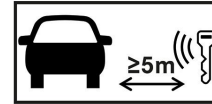

Motor sesinin duyulmaması aracın kapatılmış olduğu anlamına gelmez.



Araç işletim dışı bırakılana kadar yeniden çalıştırma olanaklıdır.



### 12 V akünün ayrılması

- 12 Volt akünün kapağının çıkartılması.
- 12 Volt akünün eksi kablosunu vidalı bağlantıdan sökün ve yanlışlıkla temasa karşı emniyete alın.



Hava yastıkları ve emniyet kemeri gerdiricileri gibi pasif güvenlik sistemleri devre dışı bırakılmıştır.



#### 4. Araç yolcularına erişim

Yolcuları kurtarıırken emniyet sistemi bileşenleri (özellikle piroteknik elemanlar) sayfa 1'deki bilgilere göre dikkate alınmalıdır.

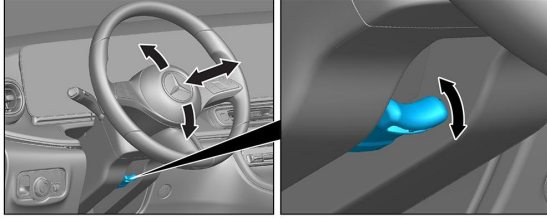

Direksiyon simidi ayarı

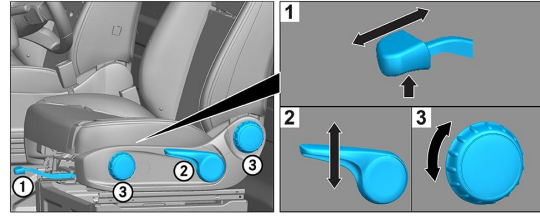

Koltuk ayarı (mekanik)

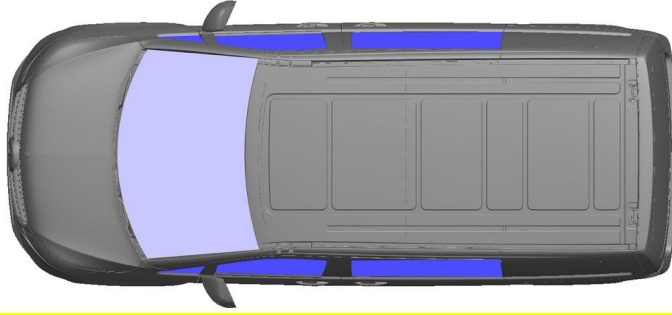

VSG: Lamine emniyet camı  
ESG: Temperli emniyet camı

#### 5. Depolanmış enerji / sıvılar / gazlar / katı maddeler

		12V
		57L
		600 ± 10g

#### 6. Araç yangını



Bir araç yangınına söndürmek için bol miktarda su (H<sub>2</sub>O) kullanın.

#### 7. Suda bulunan araçlar

Karoside gerilim olması halinde tehlike mevcut değildir. Aracı kurtarmanın ardından:

1. İç mekândaki suyun akarak boşalmasını bekleyin.
2. 12 V/48 V araç elektrik sisteminin devre dışı bırakılmasını başlatın (bkz. Bölüm 3).

#### 8. Çekme / nakliye / depolama

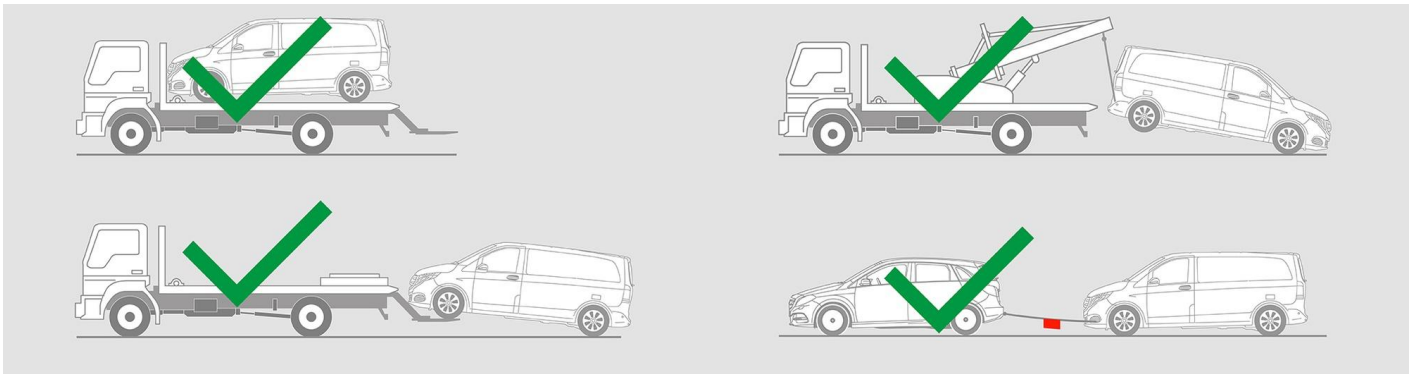

#### 9. Önemli ek bilgiler

Daha fazla bilgiyi [Binek otomobili araç çekme hizmetleri için kılavuz](#) da bulabilirsiniz.



## 10. Kullanılan piktogramların açıklaması



Sın. 1 sıvı yakıtlı araç



Tehlike



Tutuşabilir



Sağlığa zararlı



Korozif



Patlayıcı



Su ile söndürülmesi



Kuru köpükle söndürün



Smart anahtarını çıkartın



Air-conditioning component



Warning; low temperature