







-  Hava yastığı
-  Gaz jeneratörü
-  Kemer gerdiriciler
-  SRS kumanda kutusu
-  Gaz basınçlı amortisör/Ön gerilimli yay
-  Alçak voltajlı akü
-  Dizel yakıt deposu

Not: Daha fazla bilgi için lütfen [Kurtarma Kılavuzu](#)'muza bakınız.



1. Araç tanımı / tanımlama

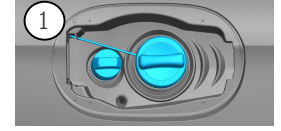

2. İşletimden alma / stabilizasyon / kaldırma

Park freni

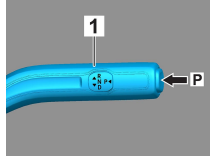

Sabitleştirici fren

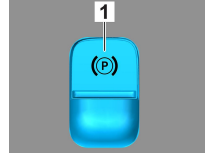
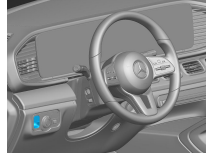

Vites seçme kolundaki (1) P şalterine basın. Park freni otomatik olarak etkinleştirilir. Elektrikli sabitleştirici fren (1)

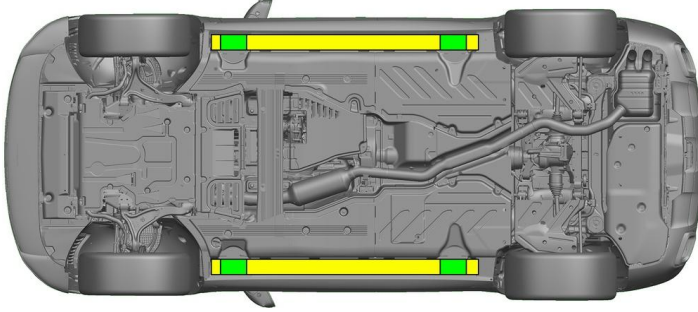

- Uygun kaldırma noktaları
- Yanda bulunan uygun stabilizasyon noktaları



Kurtarma sırasında eşiklerin ve gövde altının ek deformasyonunun (örneğin hidrolik ekipmanla desteklenerek) önüne geçilmesi gerekir.

3. Doğrudan tehlikelerin ortadan kaldırılması / güvenlik düzenlemeleri

Kontağın kapatılması:

- İşletim frenini etkinleştirmeden BAŞLAT-DURDUR (START-STOP) tuşuna basın.
- Elektronik araç anahtarını en az 5 m mesafede tutun.

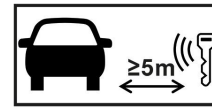

Motor sesinin duyulmaması aracın kapatılmış olduğu anlamına gelmez.



Araç işletim dışı bırakılana kadar yeniden çalıştırma olanaklıdır.



12/48 V akünün ayrılması

- 12/48 Volt akünün kapağının çıkartılması.
- 12/48 Volt akünün eksi kablosunu vidalı bağlantıdan sökün ve yanlışlıkla temasa karşı emniyete alın.



Hava yastıkları ve emniyet kemeri gerdiricileri gibi pasif güvenlik sistemleri devre dışı bırakılmıştır.



4. Araç yolcularına erişim

Yolcuları kurtarıırken emniyet sistemi bileşenleri (özellikle piroteknik elemanlar) sayfa 1'deki bilgilere göre dikkate alınmalıdır.

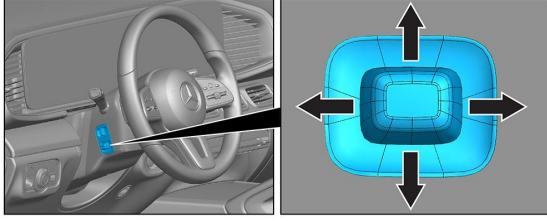

Direksiyon simidi ayarı

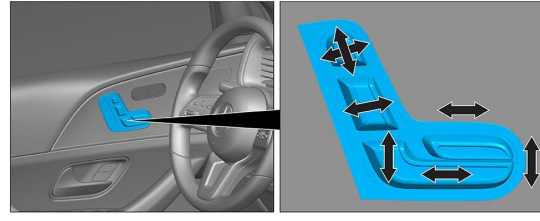

Koltuk ayarı (elektrikli)

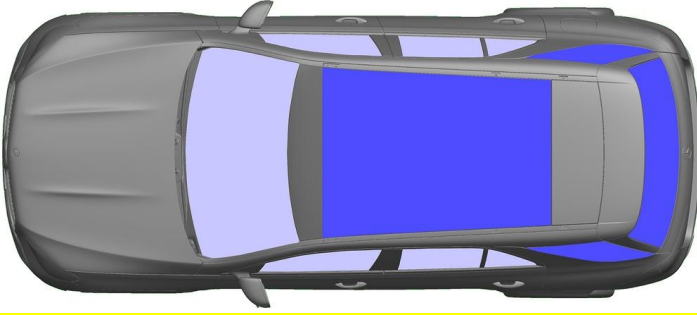

VSG: Lamine emniyet camı
ESG: Temperli emniyet camı

5. Depolanmış enerji / sıvılar / gazlar / katı maddeler

		12/48V
		85L
		660 ± 10g

6. Araç yangını



Bir araç yangınına söndürmek için bol miktarda su (H₂O) kullanın.

7. Suda bulunan araçlar

Karoside gerilim olması halinde tehlike mevcut değildir. Aracı kurtarmanın ardından:

1. İç mekândaki suyun akarak boşalmasını bekleyin.
2. 12 V/48 V araç elektrik sisteminin devre dışı bırakılmasını başlatın (bkz. Bölüm 3).

8. Çekme / nakliye / depolama

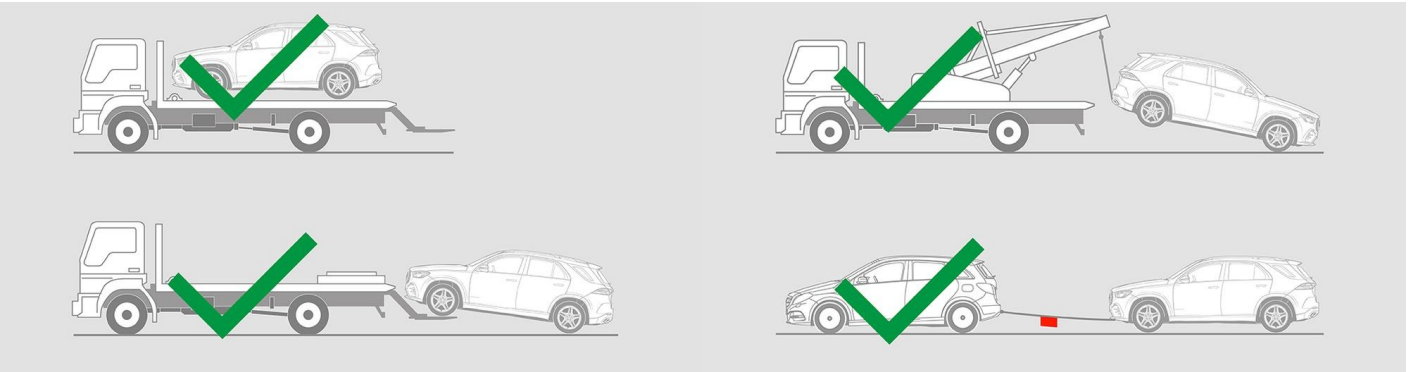

9. Önemli ek bilgiler

Daha fazla bilgiyi [Binek otomobili araç çekme hizmetleri için kılavuz](#) da bulabilirsiniz.



10. Kullanılan piktogramların açıklaması



Sın. 1 sıvı yakıtlı araç



Tehlike



Tutuşabilir



Sağlığa zararlı



Korozif



Akut toksisite



Patlayıcı



Su ile söndürülmesi



Kuru köpükle söndürün



Islak köpükle söndürün



Smart anahtarını çıkartın



Air-conditioning component



Warning; low temperature