

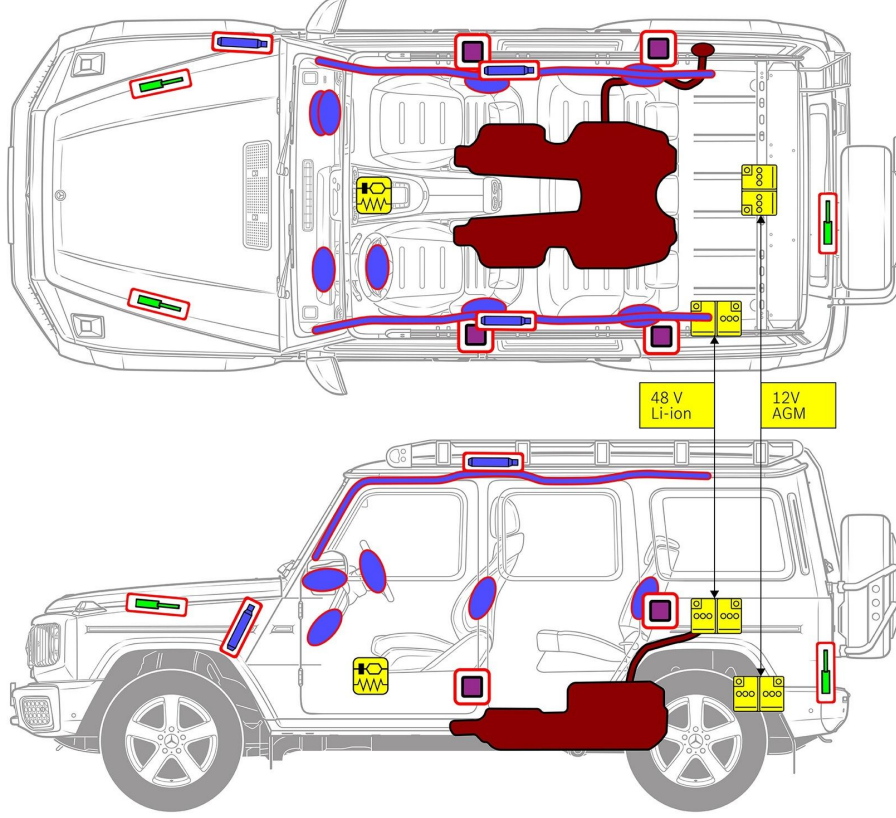

Mercedes-Benz G-Serisi 500/550 Tip W465 Arazi aracı, 2024'ten itibaren



- Hava yastığı
- Gaz jeneratörü
- Kemer gerdiriciler
- SRS kumanda kutusu
- Gaz basınçlı amortisör/Ön gerilimli yay
- Alçak voltajlı akü
- Benzin yakıt deposu

Not: Daha fazla bilgi için lütfen [Kurtarma Kılavuzu](#)'muza bakınız.



1. Araç tanımı / tanımlama



2. İşletimden alma / stabilizasyon / kaldırma

Park freni

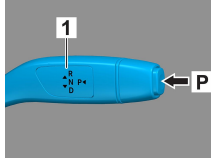

Sabitleştirici fren

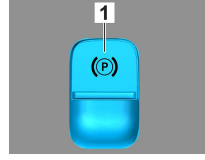
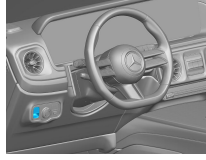

Vites seçme kolundaki (1) P şalterine basın. Park freni otomatik olarak etkinleştirilir. Elektrikli sabitleştirici fren (1)

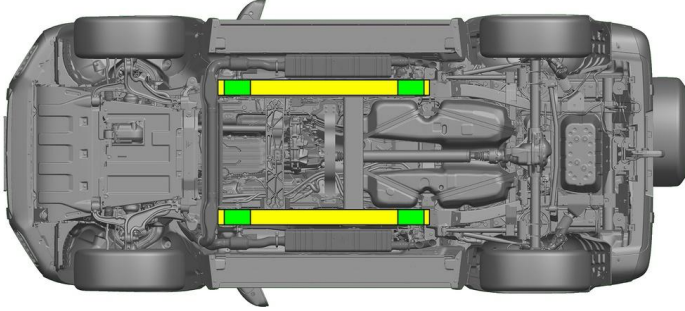

- Uygun kaldırma noktaları
- Yanda bulunan uygun stabilizasyon noktaları



Kurtarma sırasında eşiklerin ve gövde altının ek deformasyonunun (örneğin hidrolik ekipmanla desteklenerek) önüne geçilmesi gerekir.

3. Doğrudan tehlikelerin ortadan kaldırılması / güvenlik düzenlemeleri

Kontağın kapatılması:

- İşletim frenini etkinleştirmeden BAŞLAT-DURDUR (START-STOP) tuşuna basın.
- Elektronik araç anahtarını en az 5 m mesafede tutun.

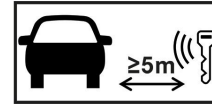

Motor sesinin duyulmaması aracın kapatılmış olduğu anlamına gelmez.



Araç işletim dışı bırakılana kadar yeniden çalıştırma olanaklıdır.



48 voltluk akünün sökülmesi

- Bagaj bölmesinin taban plakasını sökün (4 tespit halkasını sökün), sonra 48-Voltluk aküye erişmek için farklı kaplamaları (C, D direği, taban kenarı vs.) ve yan duvar kaplamasını sökün.
- Vidalı bağlantıdaki 48 voltluk akünün eksi kablosunu çözün ve istem dışı temasa karşı emniyete alın.





12 voltluk akünün sökülmesi

- 12-Voltluk aküye erişmek için, bagaj bölmesinin taban plakasını sökün (4 tespit halkasını sökün).
- Vidalı bağlantıdaki 12 voltluk akünün eksi kablosunu çözün ve istem dışı temasa karşı emniyete alın.



Hava yastıkları ve emniyet kemeri gerdiricileri gibi pasif güvenlik sistemleri devre dışı bırakılmıştır.

4. Araç yolcularına erişim

Yolcuları kurtarıırken, yüksek mukavemetli çelikten yapılmış karoseri bölgeleri ve sınırlama sistemlerinin bileşenleri (özellikle piroteknik elemanlar) sayfa 1'de belirtilmiş olan bilgilere göre dikkate alınmalıdır.

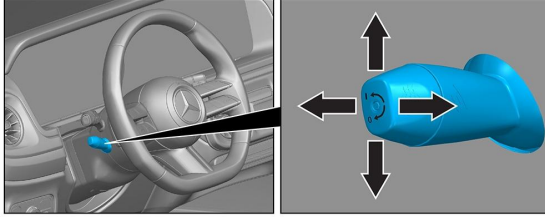

Direksiyon simidi ayarı

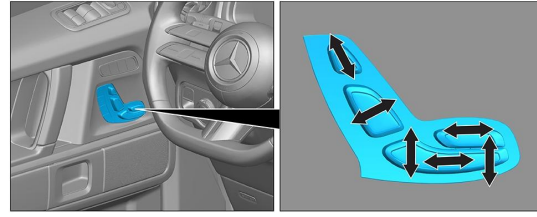

Koltuk ayarı (elektrikli)



VSG: Lamine emniyet camı

ESG: Temperli emniyet camı

5. Depolanmış enerji / sıvılar / gazlar / katı maddeler

							12/48V
							100L
							680 ± 10g

6. Araç yangını



Bir araç yangınına söndürmek için bol miktarda su (H₂O) kullanın.

7. Suda bulunan araçlar

Karoseride gerilim olması halinde tehlike mevcut değildir. Aracı kurtarmanın ardından:

- İç mekândaki suyun akarak boşalmasını bekleyin.
- 12 V/48 V araç elektrik sisteminin devre dışı bırakılmasını başlatın (bkz. Bölüm 3).



8. Çekme / nakliye / depolama

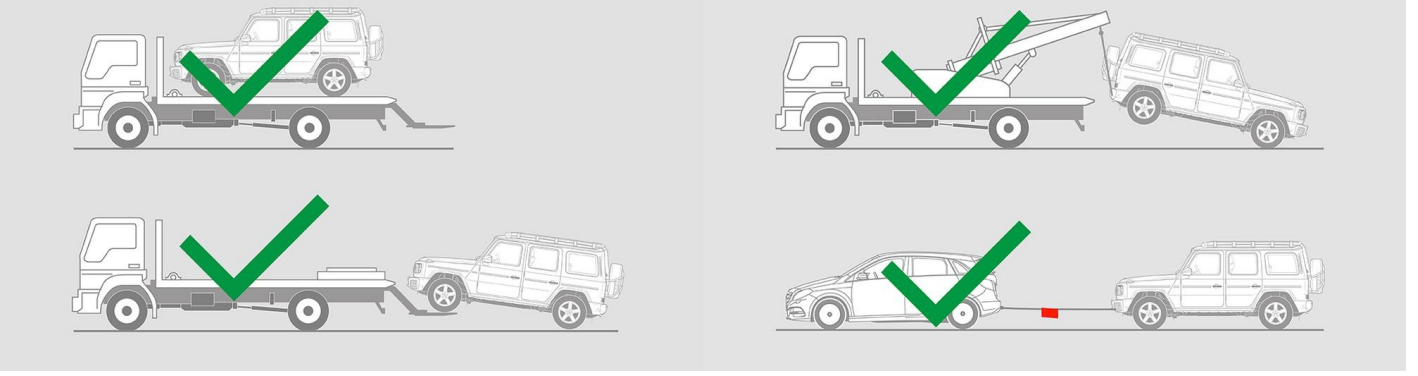

9. Önemli ek bilgiler

Daha fazla bilgiyi [Binek otomobili araç çekme hizmetleri için kılavuz](#) da bulabilirsiniz.

10. Kullanılan piktogramların açıklaması



Sin. 2 sıvı yakıtlı araç



Tehlike



Tutuşabilir



Sağlığa zararlı



Korozif



Patlayıcı



Su ile söndürülmesi



Kuru köpükle söndürün



Islak köpükle söndürün



Bagaj



Smart anahtarını çıkartın



Air-conditioning component



Warning; low temperature