







① Soldan direksiyonlu araç ② Sağdan direksiyonlu araç

- | | | | | |
|---|---|--|--|---|
|  Hava yastığı |  Gaz jeneratörü |  Kemer gerdiriciler |  SRS kumanda kutusu |  Gaz basınçlı amortisör/Ön gerilimli yay |
|  Alçak voltajlı akü |  Benzin yakıt deposu | | | |

Not: Daha fazla bilgi için lütfen [Kurtarma Kılavuzu](#)'muza bakınız.

1. Araç tanımı / tanımlama

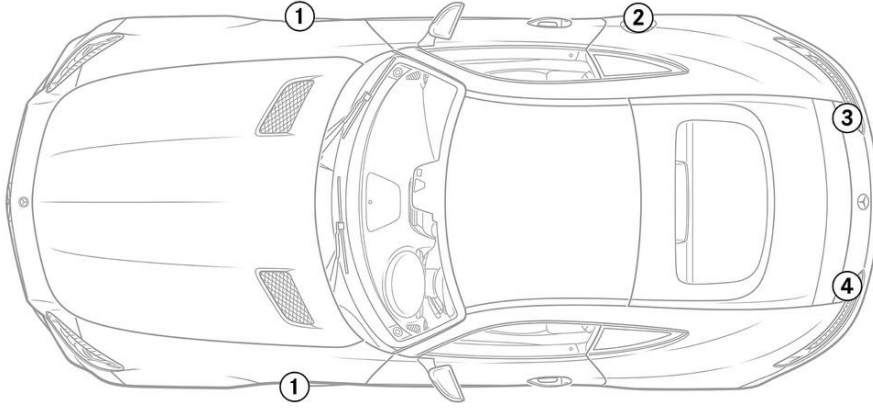

1

V8 BITURBO

2

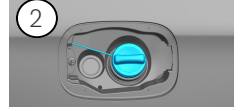

3

GT

4

AMG