











- | | | | | |
|---|--|--|--|--|
|  Krockudde |  Gasgenerator |  Bältesförsträcker |  SRS styrenhet |  Aktivt fotgängarskyddssystem |
|  Gastrycksdämpare/förspänd fjädrer |  Lågvoltbatteri |  Bensin bränsletank |  Högspänningsbatteri |  Högspänningskabel |
|  Högspänningskomponent |  Kabelsnitt |  Lågspänningssenheter som kopplar bort högspänning | | |

Observera: Mer information finns i vår [räddningsguide](#).



1. Identifiering

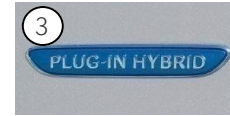
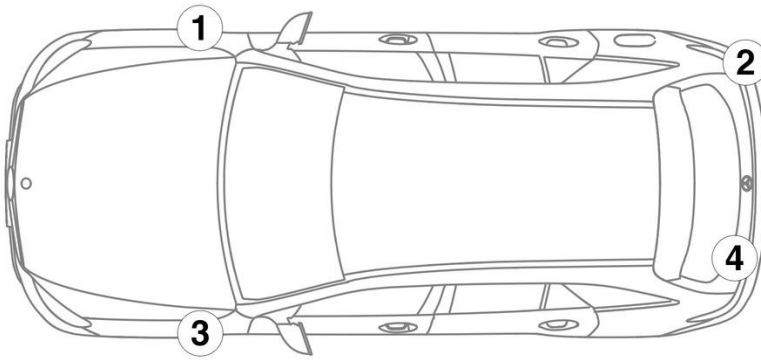

3. Oskadliggöra akuta risker/ säkerhetsföreskrifter

Inaktivering av högspänningssystem

I alla andra situationer ska högspänningssystemet inaktiveras så här:

Alternativ 1: Högspänningsfrånskiljare

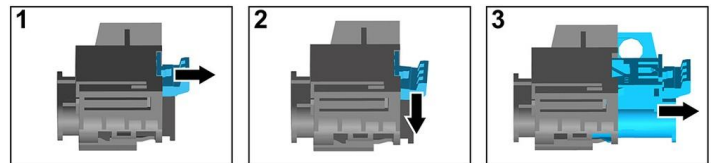
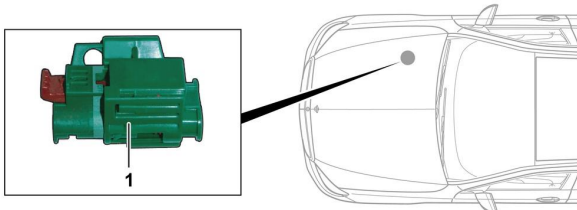

Högspänningsfrånskiljaren sitter i motorrummet på passagerarsidan.



- (1) Dra i spärren för upplåsning
- (2) Tryck spärren för upplåsning neråt
- (3) Dra ut strömbrytaren

Alternativ 2: Alternativ högspänningsfrånskiljare

Den alternativa högspänningsfrånskiljaren sitter under övertäckningen till säkringsdosan vid cockpiten på förarsidan. Den är märkt med en skylt.

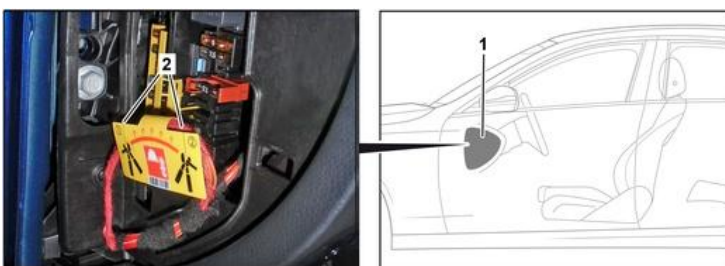

Ta bort övertäckningen (1). Kapa ledningen på det markerade stället (2).



Koppla loss 12-voltsbatteriet

1. Ta bort övertäckningen från 12-voltsbatteriet.
2. Lossa minuskabeln från skruvförbandet på 12-voltsbatteriet och säkra den mot oavsiktlig kontakt.