

Guidelines for rescue personnel Cars, vans and off-road vehicles

in accordance with ISO standard 17840-3



Mercedes-Benz



Legal notice

You can also find detailed information about our complete product portfolio on our Internet portal:

aftersales.mercedes-benz.com

Questions, comments and suggestions

If you have questions, comments, or suggestions regarding this product, please write to us.

Email: rescue-assist@daimler.com

@ 2021 by Mercedes-Benz AG

This documents, including all of its parts, is protected by copyright. Any exploitation or use requires prior written approval from Mercedes-Benz AG, GSP/ORR department, 70546 Stuttgart, Germany. This applies in particular for the reproduction, dissemination, editing, microfilming and storage and/or processing in electronic systems, including databases and online services.

Foreword

Dear readers,

The current edition meets the requirements of ISO 17840-3 with regard to standardized structure, colours and pictograms. Information concerning new drive technologies, e.g. vehicles with electric drives or fuel cell systems, constitutes a substantial part of this emergency response guide. Compared with conventional vehicles, new drive technologies require additional measures for the safe handling of vehicles which have been involved in an accident.

We would like to expressly state that this emergency response guide makes no claim to completeness and should not, nor is intended to constitute a replacement for proper training and relevant technical literature under any circumstances. The information in the emergency response guide is expressly limited to vehicles classified as passenger cars (M1 in accordance with 2007/46/EC). Always observe the country-specific laws and guidelines. Mercedes-Benz AG Retail Operation (GSP/ORR).

Illustrations in this emergency response guide are by way of example and may be different to the vehicle on which you are working. The installation position of the components which are relevant for the operation can be found in the vehicle-specific rescue sheet ([“The digital Mercedes-Benz rescue assistant”](#) section). Vehicle-specific information can be found in the manual for the vehicle.

Table of contents

0. General	
Introduction	8
The digital Mercedes-Benz rescue assistant	9
1. Identification/recognition	
General distinguishing features	12
Identifying features by drive type	14
2. Immobilization/stabilization/lifting	
General considerations	25
Immobilization/stabilization	26
Stabilization/lifting	29
3. Disabling direct dangers/safety regulations	
Switching off the drive system	32
Securing the vehicle against rolling away	34
Opening the bonnet	36
Switching off the 12/48-V electrical system	38
Switching off the high-voltage electrical system	40
Switching off the natural gas system	48
Switching off the fuel cell system	51
4. Access to the occupants	
Access possibilities	56
Bodyshell structures	60
Structure reinforcements in lightweight design	62
Cut zones for rescue personnel	63
Glass management	65
Vehicle operation	66
Entry and egress assistance	70

Table of contents

5. Stored energy/liquids/gases/solids	
Leaking operating fluids	73
Types of voltage and electrical systems	75
Information concerning high-voltage batteries	77
Information concerning high-voltage electrical systems	82
Vehicles with combustion engines (petrol/diesel)	83
Vehicles with natural gas engines NGT/NGD (CNG)	85
Vehicles with hybrid drives (HEV)	87
Vehicles with plug-in hybrid drives (PHEV)	88
Vehicles with electric drives (BEV)	90
Vehicles with fuel cell systems (F-CELL)	92
6. In case of fire	
Information to be observed in case of fire	97
Petrol/diesel vehicles	99
Vehicles fuelled by natural gas	100
Electric vehicles.	101
Vehicles with fuel cell systems	104
7. In the event of submersion in water	
Observe for vehicles in water	106
Vehicles with high-voltage on-board electrical systems	109
Possible scenarios for vehicles in water	110
8. Towing/transportation/storage	
Safety precautions	114
Towing/transportation	115
Storage	117
9. Important additional information	
Airbags/restraint systems	120
Roll-over protection	126
Active bonnet.	128
High-voltage components	130
Other innovations	132
10. Pictogram overview	
11. Annex	

0. General

List of abbreviations

ADR	Accord européen relatif au transport international des marchandises Dangereuses par Route (ADR) – Agreement concerning the International Carriage of Dangerous Goods by Road
BEV	Battery Electric Vehicle (vehicle with a battery as the sole energy storage system)
CCS	Combined Charging System
CFRP	Carbon Fibre-Reinforced Plastic
CNG	Compressed Natural Gas
CTIF	Comité Technique International de prévention et d'extinction du Feu – International Technical Committee for the Prevention and Extinction of Fire
F-CELL	Fuel-CELL (hydrogen-based fuel cell component)
TG	Tempered Glass
HEV	Hybrid Electric Vehicle (vehicle with two drives, electric drive and combustion engine)
HV	High Voltage
ICE	Internal Combustion Engine
LPG	Liquefied Petroleum Gas
ISO	International Organization for Standardization
LV	Low Voltage
NGD	Natural Gas Drive (natural gas engine)
NGT	Natural Gas Technology
PHEV	Plug-in Hybrid Electric Vehicle (vehicle with two drives, electric and combustion engine, as well as a vehicle power socket for charging the high-voltage battery)
PWA	Progressive Web App
REES	Rechargeable Electrical Energy Storage Systems
REX	Range Extended Electric Vehicle
SOC	State Of Charge
SRS	Supplemental Restraint System
LSG	Laminated Safety Glass

Introduction

This emergency response guide supplements the vehicle-specific rescue sheets ([“The digital Mercedes-Benz rescue assistant”](#) section) with information concerning drive technologies, safety systems and innovations in vehicles from Mercedes-Benz and smart. In principle, the sections of this emergency response guide are in line with ISO 17840-3, supplemented by approaches for specific accident situations (e.g. vehicle fire, high-voltage battery fire, rescue from water). Models and configurations which are delivered ex works are taken into consideration. Retrofit solutions and modifications which are not approved by Mercedes-Benz are excluded from consideration.

Identification of the vehicle involved in an accident is extremely important because different circumstances need to be taken into consideration depending on the class and further depending on the vehicle model designation. Possible immobilization and lifting points, as well as technologies and prohibited points of action.

In addition to providing suggestions for disabling direct dangers for the accident victim and rescue personnel, this document also goes into the applicable safety regulations, in particular for handling high voltages and alternative fuels.

Various technical information, such as establishment of access to the vehicle occupants, is explained. Furthermore, dangers inherent in and rules for the handling of stored energy, liquids, gases and potential hazardous solids are pointed out.

The recommended approach in case of fire, particularly with regard to alternative drives such as battery electric, hydrogen-based or using gas, is also outlined.

How to deal with vehicles involved in accidents in case of immersion or submersion in water and ultimately how to rescue them, is also set out. Finally, information is provided regarding the towing, storage and disposal of vehicles involved in accidents and further information regarding safety systems is outlined.

The digital Mercedes-Benz rescue assistant

Accessing rescue sheets via QR code

Having the right rescue sheet quickly to hand is crucial in the event of an emergency because it shows the location of airbags, stored gas inflators, batteries, high-voltage components and fuel tanks in addition to the position of body reinforcements. Mercedes-Benz has developed the rescue sticker with QR code for this. Vehicle-specific rescue sheets for new Mercedes-Benz,

Mercedes-AMG, Mercedes-Maybach and smart vehicles can be accessed quickly by scanning a QR code attached to the vehicle. The rescue stickers with QR codes are attached to the inside of the fuel filler cap and the opposite B pillar of the vehicles and also help with clear identification of the drive type.



rk.mb-qr.com



General

Progressive Web App (PWA)

Rescue personnel can find more information on the Mercedes-Benz digital rescue assistant website: rk.mb-gr.com. The website functions as a progressive web app (PWA) and therefore feels like a native app owing to several useful additional functions, but does not need to be downloaded from the app store. The PWA can be accessed normally via the browser. The PWA can be installed on a device (desktop PC, tablet, smartphone) in just a few steps. Detailed installation information can be found on the website above.

Offline availability of information which is relevant for rescue

Installation of the PWA has the advantage that safety-related information such as all [rescue sheets](#) can then also be accessed offline. As soon as the device gets Internet access again, the PWA is automatically updated. As a result, rescue personnel always have access to the latest information.



1. Identification/recognition

General distinguishing features

Mercedes-Benz AG currently offers vehicles with the following drive types:

ICE – Internal Combustion Engine

The vehicles are divided into the following engine types:

- Petrol engine (Otto engine)
- Diesel engine
- Natural gas engine

Vehicles with the model designation NGT (Natural Gas Technology) and NGD (Natural Gas Drive) are driven by compressed natural gas (CNG).

BEV – Battery Electric Vehicle in the EQ-Class

Vehicles driven solely by a battery-powered electric motor. These always have a connection for charging the battery from an external power supply.

HEV – HYBRID Electric Vehicle

Vehicles with two combined drive types. The electric drive is coupled with the combustion engine.

PHEV – Plug-in HYBRID Electric Vehicle

Vehicles with two integrated drive types. The vehicles can be driven both by the battery-powered electric motor and by the conventional combustion engine. They are equipped with a connection for charging the battery from an external power supply.

F-CELL (Fuel-CELL)

Vehicles with fuel cells in which the energy for the engine and the battery is generated through the conversion of hydrogen into electricity. Vehicles in the F-CELL (also referred to as Fuel-CELL) Plug-in HYBRID category are equipped with a connection for charging the battery from an external power supply.

Identification/recognition

Drive type	Type of energy storage system	Possible energy source
Vehicle with combustion engine	Fuel tank, gas tank	Petrol, diesel, CNG
Hybrid Electric Vehicle (HEV)	Fuel tank, high-voltage battery	Petrol, diesel, electricity
Plug-in Hybrid Electric Vehicle (PHEV)	Fuel tank, high-voltage battery	Petrol, diesel, electricity
Battery Electric Vehicle (BEV)	High-voltage battery	Electric current
Fuel cell electric vehicle (F-CELL)	Hydrogen fuel tank, high-voltage battery	Hydrogen, electricity

Registration number

Depending on the country-specific legislation, the registration number may be marked with an “E” at the end for the following vehicles:

- Battery electric powered vehicle
- Vehicle with electric motor, HYBRID or plug-in hybrid drive
- Vehicle with fuel cell system

During the course of motor vehicle registration in the Federal Republic of Germany, the vehicle owner is not required to apply for an E licence and thus identify their vehicle.

Identifying features by drive type

Vehicles with combustion engines

Vehicles which are driven solely by a conventional combustion engine currently account for the majority of road traffic.

There are various Mercedes-Benz hybrid vehicles (HEV, PHEV) that make use of a combustion engines in conjunction with an electric motor.

Pictograms



Vehicle with class 1 fuel (diesel)



Vehicle with class 2 fuel (petrol, ethanol, etc.)

Warning sticker

Vehicles with a 48-V electrical system have a warning sticker which pertains to the components in the vehicle which carry high voltage.



Identification/recognition

Filler pipe (1)

The filler pipe (1) for petrol or diesel, with an additional filler pipe for AdBlue® where applicable, is located under the fuel filler cap. A sticker with the indication “Premium petrol” or “Diesel” is attached to the inside of the fuel filler cap. The fuel filler cap is located on the left-hand or right-hand side of the vehicle, depending on the vehicle variant.

Type designation (2)

The type designation (2) on the boot lid does not have an “e” at the end. There are no additional designations such as EQ, CNG, NGD, NGT, or F-CELL on the vehicle.

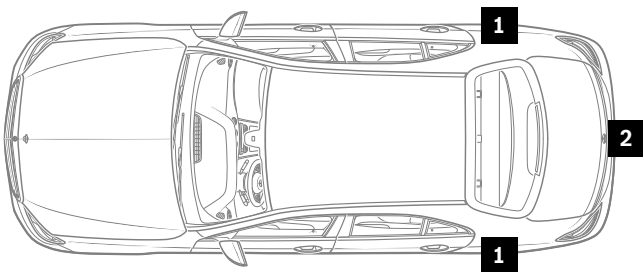

- 1 Filler pipe
- 2 Type designation



Identification/recognition

Vehicles with natural gas engines

The natural gas engine is always a dual-fuel design and can be fuelled with natural gas as well as petrol. A natural gas vehicle has both a fuel tank and the gas tank. A Mercedes-Benz vehicle with a natural gas engine can be recognized from the following features:

Pictograms



Vehicles fuelled by natural gas

Overview of models

- E-Class saloon, Type 211
- E-Class saloon, Type 212
- B-Class tourer, Type 242
- B-Class tourer, Type 245

The electronic instrument cluster has a separate range indicator for petrol and natural gas operation and the lettering CNG, NGT, or NGD.

Information about the vehicle-specific energy storage systems can be found in the [“Stored energy/liquids/gases/solids”](#) section.

Identification/recognition

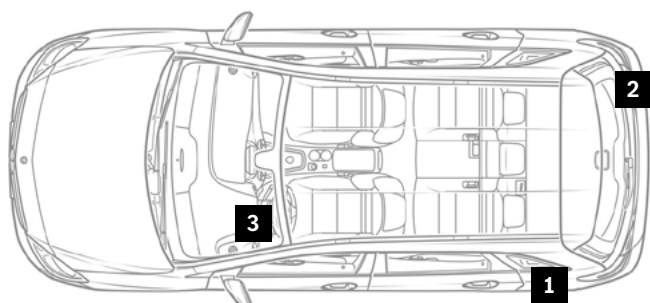

- 1 Natural gas filler pipe
- 2 NATURAL GAS type designation
- 3 Electronic instrument cluster display



Vehicles with (plug-in) hybrid drives

Hybrid vehicles (HEV, PHEV) have both a fuel tank and a high-voltage battery installed. A Mercedes-Benz or smart vehicle with a hybrid drive can be recognized from the following features:

Pictograms



Hybrid electric vehicles with class 1 fuel (diesel)



Hybrid electric vehicles with class 2 fuel (petrol, ethanol, etc.)

The following variants are possible for the type designation (4): “HYBRID”, “h”, “mild hybrid”, “micro hybrid drive”, “mhd” and “e”.

Depending on the country-specific legislation, the registration number (7) may be marked with an “E”. There are separate charge indicator/fuel gages on the electronic instrument cluster (8). For vehicles with a plug-in HYBRID drive, there is also a status indicator for the operating status of the vehicle (“Ready”). Components in the vehicle which carry high voltage are indicated by a warning sticker (3). High-voltage cables have orange insulation.

Identification/recognition

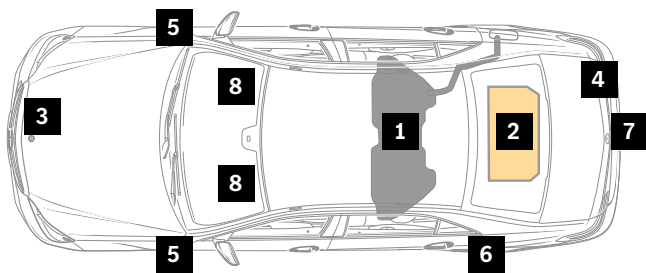

- 1 Fuel tank
- 2 High-voltage battery
- 3 Warning sticker
- 4 Type designation (on the boot lid)
- 5 Badge (on the fenders or front doors)
- 6 Charging socket cap with socket
Charging current supply
- 7 Registration number
- 8 Electronic instrument cluster display



Identification/recognition

Vehicles with electric drives

Vehicles with electric drives are driven solely by battery electric power. A Mercedes-Benz or smart vehicle with an electric drive can be recognized from the following features:

Pictograms



Vehicles with electric drives

Depending on the country-specific legislation, the registration number (5) may be marked with an “E”. Components in the vehicle which carry high voltage are indicated by a warning sticker (1). High-voltage cables have orange insulation. There is a charge indicator and the status indicator for the operating status of the vehicle (“Ready”) on the electronic instrument cluster (6).

Information about the vehicle-specific energy storage systems can be found in the [“Stored energy/liquids/gases/solids”](#) section.

Identification/recognition

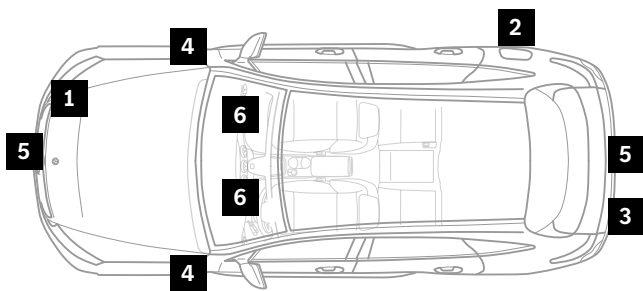

- 1 Warning sticker
- 2 Charging socket cap with socket
Charging current supply
- 3 Type designation (on the boot lid)
- 4 Badge (on the front fenders)
- 5 Registration number
- 6 Electronic instrument cluster display

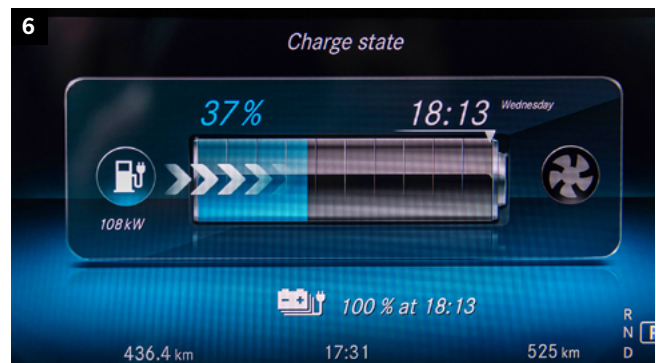

Identification/recognition

Vehicles with fuel cell systems

Vehicles with fuel cell systems are equipped with a hydrogen fuel tank and a high-voltage battery. A Mercedes-Benz vehicle with a fuel cell system can be recognized from the following features:

Pictograms



Vehicles with fuel cell systems

Overview of models

- B-Class tourer, Type 245
- GLC SUV, Type 253

The electronic instrument cluster shows a power availability indicator instead of the tachometer and the status indicator for the operating status of the vehicle (“Ready”) (6). Components in the vehicle which carry high voltage are indicated by a warning sticker (1). High-voltage cables have orange insulation. The following variants are possible for the type designation (3): “EQ”, “f”, “Fuel-CELL”.

Information about the vehicle-specific energy storage systems can be found in the [“Stored energy/liquids/gases/solids”](#) section.

Identification/recognition

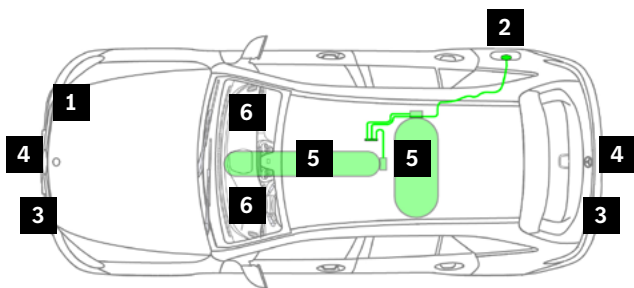

- 1 Warning sticker
- 2 Cap with charging current supply socket and TN1 filler pipe for hydrogen
- 3 Type designation (on the boot lid, on radiator grill, or on the front fenders)
- 4 Registration number
- 5 Hydrogen fuel tank in the underbody
- 6 Indication in the Audio/COMAND display



2. Immobilization/stabilization/lifting

General considerations

General warning sign



Risk of injury owing to unintentional movement of the bodywork.
Secure and stabilize the vehicle before working on the bodywork.
More information on [page 155](#)

Modern vehicles have components which may be active even in vehicles which have been involved in an accident or are parked, as well as with the combustion engine/drive system switched off.

ECO start/stop function/HOLD function

The engine has been switched off situationally. All vehicle systems are still active. The indicator light (“tell-tale”) or the appropriate display on the electronic instrument cluster is lit. In certain situations, the engine can automatically be started again and the vehicle can start or roll away. Depending on the accident situation, it may not be possible to determine whether the vehicle is “ON” or “OFF”.

In general, it should be assumed that all vehicles are “ON” when found.

Before starting rescue operations, it is essential to ensure that the vehicle is switched off (see the “[Switching off the drive system](#)” section). It is also recommended to secure vehicles which have been involved in an accident against rolling away using chocks (see the “[Securing the vehicle against rolling away](#)” section).

Immobilization/stabilization

In order to create sufficient space for underfloor sliding blocks or scaffolding, the vehicle can be raised with a spreader. Immobilization of the vehicle should be done such that a permanent, secure hold is guaranteed even with the use of equipment, and should also support hydraulic equipment to the greatest extent possible. Substructures and wedges stabilize the vehicle and, when used correctly, can support the rescue equipment. Vehicles which are on their side should be secured against slipping and tipping over, e.g. with scaling ladders, chocks, ropes and lashing straps.

Possible immobilization points

In general, axles, wheel suspension systems and wheels, longitudinal and transverse members, A, B, C pillars and towing eyes and trailer couplings can be used as immobilization points. Here, lashing straps and slings should be run across multiple points wherever possible in order to achieve distribution of the load. The trailer couplings/towbars or rope winches on the emergency vehicle, for example, can be used as suitable counterpoints.

Example

- Securing a vehicle on its side with scaling ladders.
- Attach lashing straps by looping them around parts of the vehicle such as axles or other firmly screwed or welded parts on the vehicle.
- Attach a steel cable to the lashing strap and tension it with towing equipment (grip hoist) or a rope winch.
- Secure the opposite side of the vehicle with chocks.

- 1 Lifting with a spreader
- 2 Scaffolding, underfloor sliding blocks
- 3 Securing a vehicle on its side



Immobilization/stabilization/lifting

Towing eye

The towing eye on Mercedes-Benz vehicles is located under the boot or load compartment floor. In smart models, it is located under the passenger seat carpet in the footrest.

Example: Mercedes-Benz, Mercedes-Benz AMG and Mercedes-Maybach

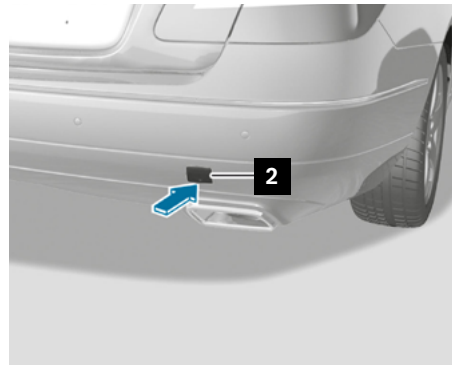
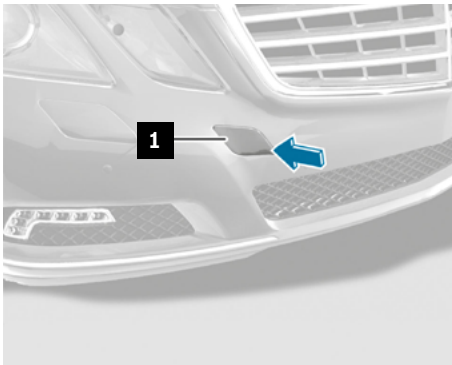

Example: smart vehicle

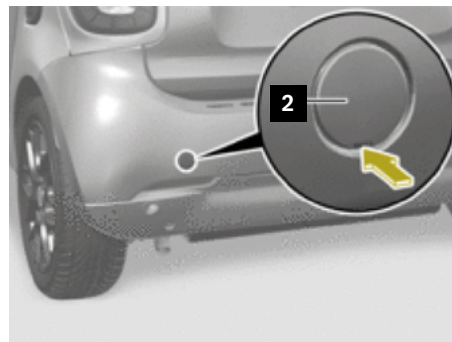
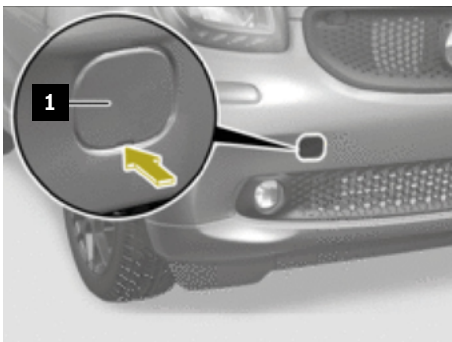

- 1 Front cover
- 2 Rear cover

Immobilization/stabilization/lifting

Round sling

If the vehicle is on steep terrain, then the round sling is an appropriate option for securing the vehicle. It can also be used for the recovery of the vehicle.

The round sling is attached as follows:

- Run it through the window openings (also with the windows removed).
- Looping around parts of the vehicle such as axles or other firmly screwed/welded parts on the vehicle. Care must be taken here to ensure that it is looped around several parts wherever possible in order to achieve distribution of the forces which occur.



Stabilization/lifting

General warning sign



Danger of death owing to the vehicle slipping or tipping while lifting.
Only lift the vehicle at the attachment points stipulated by the vehicle manufacturer.
More information on [page 139](#)

Jack attachment points

Wherever possible, the stipulated jack attachment points (1) should be used for stabilization/lifting. Depending on the accident situation, it may be necessary to use other components or parts of the vehicle for stabilization/lifting. The information regarding prohibited vehicle parts must be observed

in these cases in particular. For some vehicle models, a cover must be removed first. Vehicle-specific information can be found in the manual for the vehicle. In principle, the position of the jack attachment point shown in the figure applies to all Mercedes-Benz and smart vehicles.

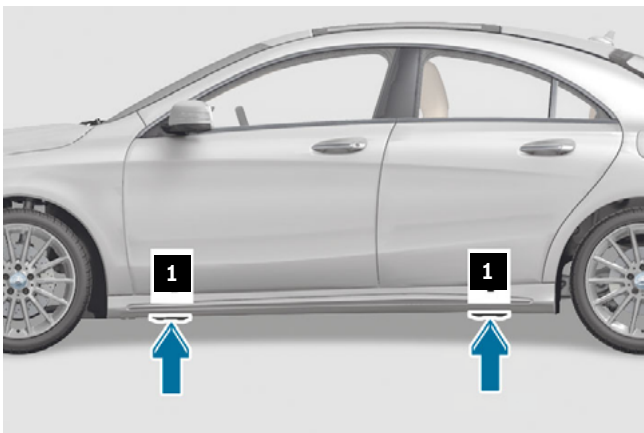

1 Jack attachment points

Immobilization/stabilization/lifting

Unsuitable vehicle parts

The vehicle should not be lifted at the positions of the fuel or gas tanks, the high-voltage battery or drive train components under any circumstances, as this may result in damage with high hazard potential.

The support position must also be selected such that no damage occurs. For example, a single support underneath the B pillar can result in the vehicle buckling in the event of a large side opening.

When using the rescue equipment, make sure that potentially hazardous components are not damaged. Potentially hazardous components include the high-voltage battery, high-voltage cables, gas and fuel tanks, stored gas inflators and shock absorbers. Vehicle-specific information can be found in the relevant rescue sheet (see the [“The digital Mercedes-Benz rescue assistant”](#) section).

- 1 Fuel tank
- 2 High-voltage battery

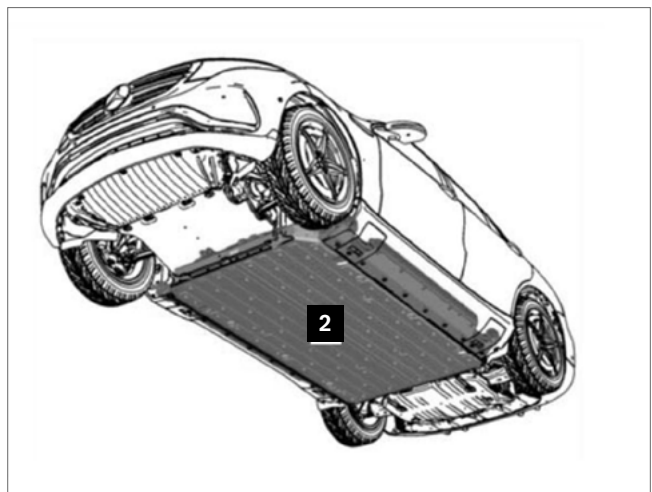
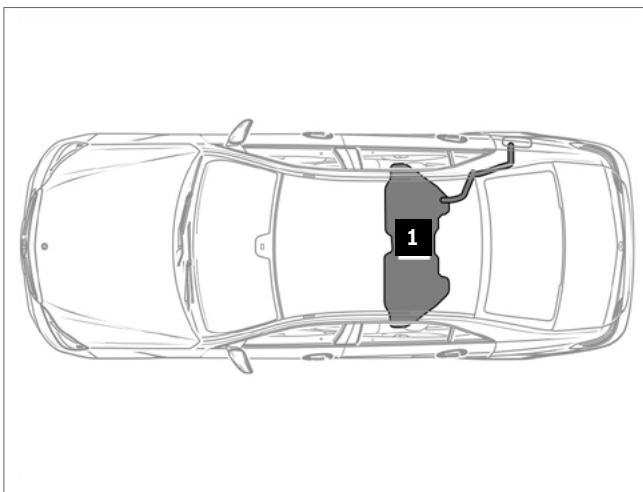

3. Disabling direct dangers/ safety regulations

Switching off the drive system

Self-protection is an important aspect in rescuing accident victims. This section will go into the dangers which are present for the accident victim as well as for the rescue personnel and what measures can minimize a risk.

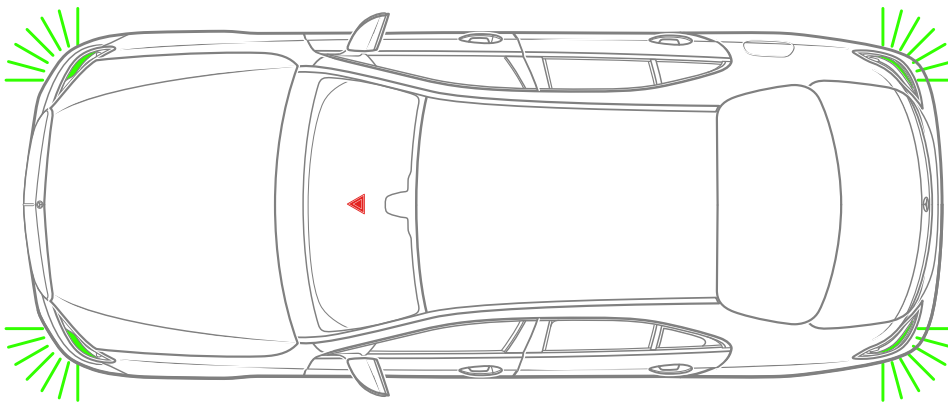

After at least one of the restraint systems is triggered, the hazard warning lights can switch on automatically in newer models from Mercedes-Benz, Mercedes-AMG, Mercedes-Maybach and smart, provided that the power supply in the vehicle is active. In addition to providing vehicle protection, this serves to indicate that the power supply is active. Self-protection is the top priority during all rescue operations.

Appropriate protective clothing must always be worn. Leaking fuel and escaping gas can catch fire. Furthermore, if it reaches a certain concentration in the air, gas can explode and can result in frostbite in the event of contact with the skin. Brake fluid is corrosive and results in skin irritations. Fuel vapours are harmful to health; inhalation should be strictly avoided.

Disabling direct dangers/safety regulations

Ignition key and start/stop button

Vehicles with ignition key (1)

In order to switch off the engine, turn the ignition key (1) counterclockwise to the “0” position and remove it.

In vehicles with automatic transmission, the ignition key (1) can only be removed in the “P” gearbox setting. Some vehicles have an entry and egress assistance convenience function, which adjusts the seat and steering wheel position when the ignition is switched on or off. In order to avoid moving a person who is presumed to be injured, the battery must be disconnected as a priority instead of actuating the ignition. Alternatively, the movement can be stopped by pulling an element of the seat/steering column adjustment system during the movement of the seat and the steering wheel. Depending on the type of accident, the windows (and also the roof in convertibles, if a risk to the vehicle occupants can be excluded) should be opened using the electric window regulator while the ignition is still switched on.

Vehicles with start/stop button (2)

KEYLESS-GO is a keyless access and vehicle permissions system. Accident situations in which the engine continues running after the accident are possible. If the vehicle key (1) is not in the ignition lock in vehicles with automatic transmission and a start/stop button (2), then the engine can be switched off as follows: put the gear selector into the “P” or “N” position. Press the start/stop button (2) once.

Depending on the model, the start/stop button (2) is located on the top of the gear selector or on the ignition lock instead of the ignition key (1). For KEYLESS-GO systems, the “key” should be kept at least 5 m away from the vehicle in order to prevent the engine from accidentally being started.



- 1 Ignition key
- 2 Start/stop button

Securing the vehicle against rolling away

Parking brake

One of the following variants may be installed. Vehicle-specific information can be found in the manual for the vehicle.

Electric parking brake

This variant is installed in current Mercedes-Benz cars.

- Actuating the parking brake: Press the electric parking brake button (1).
- Releasing the parking brake: Switch off the ignition and pull the electric parking brake button (1).

Manual parking brake (variant 1, with pedal)

This variant is installed in some older Mercedes-Benz cars.

- Actuating the parking brake: Actuate the parking brake pedal (2).
- Releasing the parking brake: Pull the parking brake handle (3).

Manual parking brake (variant 2, with lever)

- Actuating the parking brake: Pull the parking brake lever (4) firmly up.
- Releasing the parking brake: Pull the parking brake lever (4) up slightly, press the parking brake lever release (5) and guide the parking brake lever (4) down to the stop.

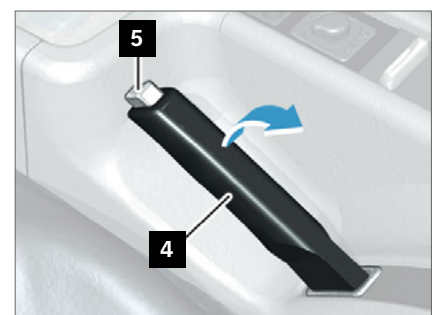
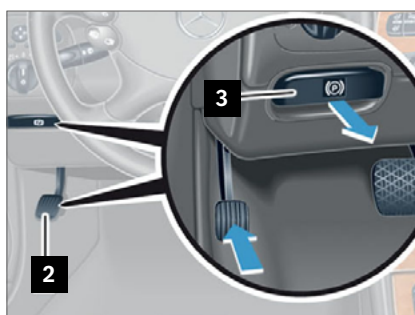

- 1 Electric parking brake button
- 2 Parking brake pedal
- 3 Parking brake handle

- 4 Parking brake lever
- 5 Parking brake lever release

Disabling direct dangers/safety regulations

Engaging the “Parking lock (P)” gearbox setting

Vehicles with automatic transmission gear selector (1) on the steering wheel:

- Press the “P” button (2) on the automatic transmission gear selector on the steering wheel (1).

Vehicles with automatic transmission gear selector on the centre console (3):

- Move the automatic transmission gear selector on the centre console (3) to the “Parking lock (P)” gearbox setting. The actuator button for releasing the gear selector is located on the front of the gear selector, for example.

Information for vehicles with automatic transmission gear selector on the steering wheel (1) (Shift-by-Wire gear shift): The desired gearbox setting is only engaged if this is also displayed in the gearbox setting indicator on the electronic instrument cluster. If you engage the “Park” gear (P) and the gearbox setting indicator does not display “P”, secure the vehicle against rolling away using the parking brake and/or chocks.

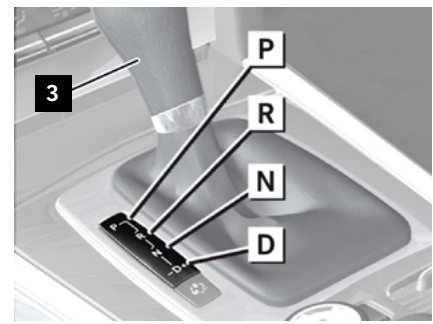
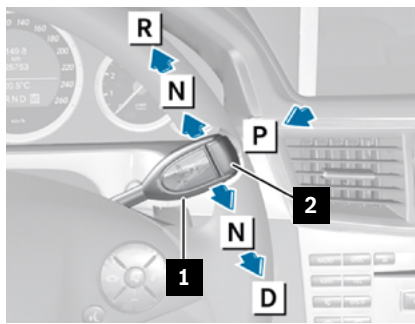

- 1 Automatic transmission gear selector on the steering wheel
- 2 “P” button
- 3 Automatic transmission gear selector on the centre console

- D “Drive” gear
N “Neutral” gear
P “Park” gear
R “Reverse” gear

Opening the bonnet

Mercedes-Benz, Mercedes-AMG and Mercedes-Maybach vehicles

The release lever (1) which opens the bonnet lock is located in the vehicle interior below the cockpit. Most Mercedes-Benz vehicles have a front-mounted engine.

Example: Mercedes-Benz E-Class vehicle, Type 212

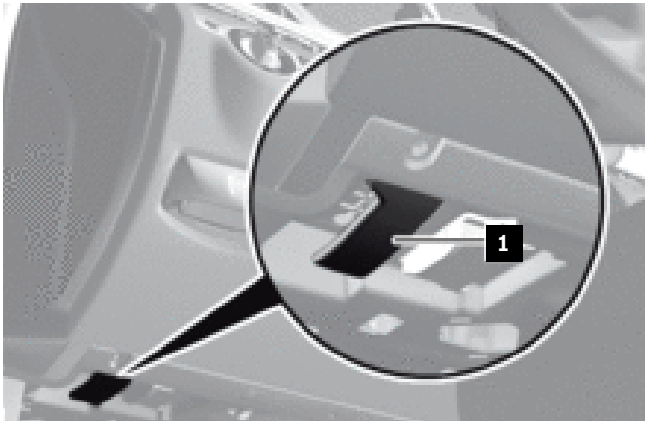

To open the bonnet, proceed as follows:

- Pull the release lever (1).
- Turn the bonnet safety catch handle (2) to the left by hand (back of the hand up) to the stop.
- Open the bonnet.

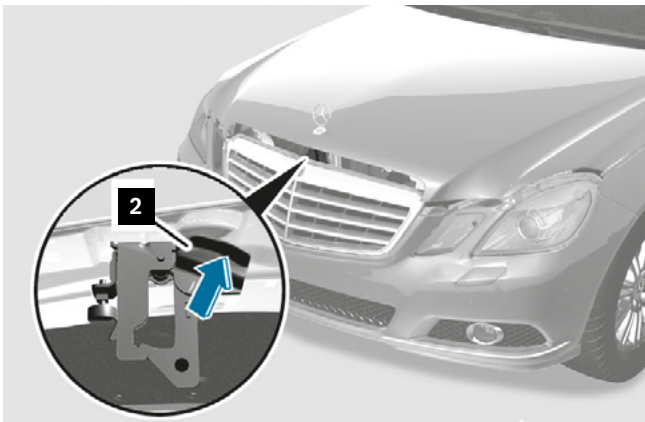

It may be necessary to open the bonnet in order to gain access to the engine compartment for the following operations:

- Actuating the high-voltage disconnect.
- Disconnecting the 12 V/48 V battery.

- 1** Release lever
- 2** Handle

Disabling direct dangers/safety regulations

smart vehicles

The engine in smart vehicles is in the rear. To open the engine compartment cover, proceed as follows:

- smart fortwo coupé (hatchback): Open the top and bottom tailgate
- smart fortwo cabrio (convertible): Open the lower tailgate and fold the rear soft top up
- Remove the carpet
- Unscrew the engine compartment cover screws
- Remove the engine compartment cover

Vehicle-specific information can be found in the manual for the vehicle.



Switching off the 12/48-V electrical system

Pictograms

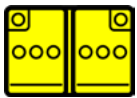

Battery low voltage

Possible battery/batteries installation locations:

- Engine compartment
- Boot
- Vehicle interior, e.g. under the driver or passenger seat
- Under the front flap (smart vehicles)

Example: Mercedes-Benz E-Class vehicle, Type 212

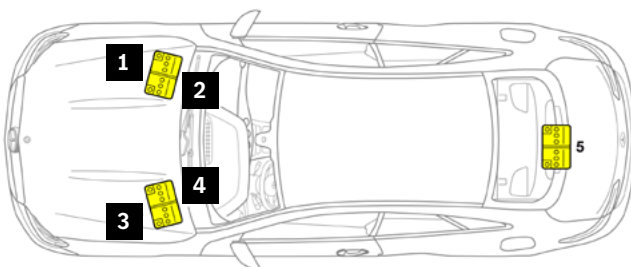

- 1 12 V battery, vehicles with 12-V electrical system, left hand drive
- 2 48 V battery, vehicles with 48-V electrical system, left hand drive
- 3 12 V battery, vehicles with 12-V electrical system, right hand drive
- 4 48 V battery, vehicles with 48-V electrical system, right hand drive
- 5 12 V battery, vehicles with 48-V electrical system

Example: Smart fortwo coupé, Type 453

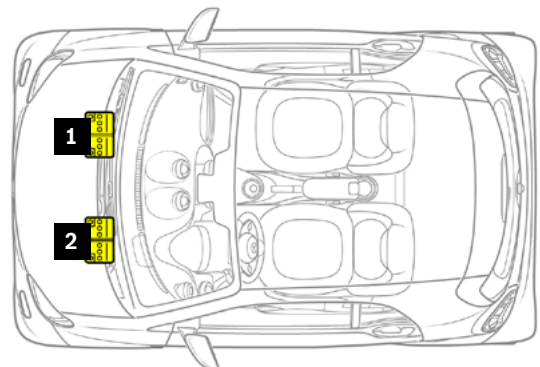

- 1 12 V battery, left hand drive
- 2 12 V battery, right hand drive

Disabling direct dangers/safety regulations

General warning sign



Risk of fire/explosion owing to short circuit and leaking oxyhydrogen gas. Risk of burns/injury owing to burns to eyes, skin and mucous membranes owing to battery electrolyte/smoke, short circuit and arc exposure. Risk of poisoning owing to swallowing battery electrolyte or absorption of lead through the skin or orifices. Danger of death owing to electric voltages $U \geq 30 \text{ V AC}$ and $U \geq 60 \text{ V DC}$.

Fire, sparks, open flames and smoking are prohibited. Wear acid-resistant gloves, clothing and goggles. Only pour battery acid into suitable and appropriately labelled containers.

More information on [page 139](#)

Disconnection of the 12-V electrical system

When disconnecting the batteries or disconnecting electrical cables, always disconnect or sever the ground wires (black) first, otherwise there is a risk of short circuit. If this is not possible, electrically insulated tools must be used for disconnecting or severing the wires. Disconnect the 12 V battery from the electrical system, e.g. by disconnecting the ground wire from the 12 V battery. In addition, unplug the signal connector or sever the signal line.

In vehicles with a dual-battery electrical system, both batteries must be disconnected. If just one battery is disconnected, then the other battery powers the airbags, meaning that these remain active.

Disconnection of the 48-V electrical system

Decommission the 12-volt electrical system. The 48-volt electrical system is automatically disconnected after around 10 s.

Automatic deactivation of the 48-volt electrical system

The 48-volt electrical system is deactivated as soon as the restraint systems control unit detects a major accident and a restraint system has been triggered. In this case, the power supply (terminal 30c) is disconnected by a pyrofuse.

If no restraint system has been triggered, then the 48-V electrical system is not deactivated automatically. This may be the case in the event of a so-called “stationary crash”, for example, when a parked vehicle is involved in an accident.

Determine the type (12 V/48 V), number and configuration of the batteries using the vehicle-specific rescue sheet (see the “[Rescue sheets](#)” section).

Switching off the high-voltage electrical system

General warning sign



Risk of fire/explosion owing to short circuit and leaking oxyhydrogen gas. Risk of burns/injury owing to burns to eyes, skin and mucous membranes owing to battery electrolyte/smoke, short circuit and arc exposure. Risk of poisoning owing to swallowing battery electrolyte or absorption of lead through the skin or orifices. Danger of death owing to electric voltages $U \geq 30$ V AC and $U \geq 60$ V DC. Fire, sparks, open flames and smoking are prohibited. Wear acid-resistant gloves, clothing and goggles. Only pour battery acid into suitable and appropriately labelled containers.

More information on [page 139](#)

Pictograms



Vehicle with electric drive



Hybrid electric vehicle with class 1 fuel (diesel)



Hybrid electric vehicle with class 2 fuel (petrol, ethanol, etc.)



Vehicle with fuel cell system

Disabling direct dangers/safety regulations

The high-voltage electrical system has orange cables and is insulated from the vehicle. The basic design of the high-voltage electrical system and the rescue-related information resulting from this are independent of the vehicle type. An overview of vehicles with alternative drives can be accessed at rk.mk-qr/de/alternative_engines or using the QR code shown.



System-side protection against the dangers posed by electric current

All components which are operated at high voltage have contact protection. Provided it is undamaged, this ensures effective protection against the dangers posed by electric current. In order to prevent cable overloads, the high-voltage electrical system is automatically switched off in the event of a short circuit.

As soon as a certain severity of accident is detected in the event of a collision, the high-voltage electrical system is switched off. To this end, relays are opened in the high-voltage battery to prevent further power from being supplied to the high-voltage electrical system. Within a few seconds, components which are connected to the high-voltage battery are sufficiently discharged so that only a non-critical voltage level is still present.

In the event of less serious accidents, a reversible disconnection occurs preventively only through a simple switch-off signal. If the driver attempts to restart the vehicle, an insulation test is carried out automatically before the vehicle switches back on. If no insulation faults are detected here, then a restart is permitted.

In the event of serious accidents after which it is not possible to continue driving anyway, the high-voltage electrical system is irreversibly disconnected through ignition of the pyrofuse. The vehicle can no longer be started.

Disabling direct dangers/safety regulations

Possible approaches, depending on the damage

1. Vehicle slightly damaged by an accident

Characteristics	Approach
None of the restraint systems (airbags or seat belt pretensioner) were triggered.	Switch off the drive system and secure the vehicle against rolling away (see the “Securing the vehicle against rolling away” section).
The high-voltage battery is not visibly damaged.	Actuating the high-voltage disconnect.
The high-voltage battery is not visibly damaged, a warning is displayed on the electronic instrument cluster display.	Observe the information in the “Stored energy/information concerning high-voltage batteries” section.

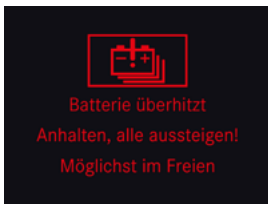

Warning on the electronic instrument cluster display.

2. Vehicle significantly damaged by an accident

Characteristics	Approach
At least one of the restraint systems (airbags or seat belt pretensioner) was triggered.	Ensure that the drive system is switched off and secure the vehicle against rolling away (see the “Securing the vehicle against rolling away” section). Actuating the high-voltage disconnect.
The high-voltage battery is not visibly damaged, a warning is displayed on the electronic instrument cluster display (see above).	Observe the information in the “Stored energy/information concerning high-voltage batteries” section.
The high-voltage battery is visibly damaged.	Observe the information in the “Stored energy/liquids/gases/solids” section.

Disabling direct dangers/safety regulations

3. Stationary vehicle (including charging)

Characteristics	Approach
None of the restraint systems (airbags or seat belt pretensioner) were triggered.	Switch the high-voltage electrical system off manually. Actuating the high-voltage disconnect.
	If the high-voltage battery is damaged, observe the information in the “Stored energy/liquids/gases/solids” section.
The vehicle is connected to the charging station. If the charging cable and/or the charging station is damaged during the charging process, then the technical infrastructure of the charging station provides protection in this case. The charging station is generally switched off.	If possible, contact the charging station operator’s hotline. Check the charging cable and charging cable plug for visible damage. Do not touch damaged points. The vehicle must be unlocked before unplugging the charging cable from the vehicle power socket.
The high-voltage battery is visibly damaged.	Observe the information in the “Stored energy/liquids/gases/solids” section. Unplug the charging cable from the vehicle power socket.



Disabling direct dangers/safety regulations

Warning sticker



Safety information

All components which are operated at high voltages are indicated by warning stickers. High-voltage cables for supplying components are indicated by the colour orange.

The high-voltage electrical system is electrically isolated (insulated) from the 12-V electrical system. Contact with damaged high-voltage components in a vehicle should be strictly avoided under all circumstances. Depending on the situation, damaged high-voltage components or cables may constitute an electrical risk. This applies in particular for vehicles which were involved in an accident and are thermally damaged or have broken down owing to a technical problem.

The following protective measures must be observed:

- Do not touch high-voltage cables (orange) at damaged points.
- Do sever high-voltage cables (orange).
- Do not touch any high-voltage components with a damaged or broken housing, as these may in principle constitute an electrical risk.
- Always adjust the personal protective equipment as appropriate for the situation.
- Only lift components of high-voltage energy storage systems which have become separated using electrically insulating equipment. The further course of action should be decided depending on the situation and position.
- It is recommended to cover live parts with a suitable, electrically insulating flexible cover (e.g. in accordance with IEC 61112).
- Severing or deformation of the bodywork using rescue equipment in the vicinity of cables and components which conduct high voltage should be avoided.

Disabling direct dangers/safety regulations

Automatic deactivation of the high-voltage electrical system

The high-voltage electrical system is automatically deactivated in the event of an accident which triggers a restraint system. The high-voltage battery itself remains charged after the high-voltage electrical system is deactivated.

Determining the absence of voltage in the high-voltage electrical system depending on the type of accident

Owing to the wide range of damage scenarios, it is not possible to directly indicate the absence of voltage after an accident. Even if it appears that the high-voltage electrical system has no voltage, the high-voltage electrical system in the vehicle must always be manually deactivated (see information in this section and in the vehicle-specific rescue sheet). Alternatively, the high-voltage disconnect wire should be severed twice (see illustration in the [“Alternative high-voltage disconnect”](#) section).

Manual high-voltage disconnect

Vehicles with high-voltage electrical systems have options for manual deactivation of the high-voltage electrical system. The location and design of the high-voltage disconnect can be found in the vehicle-specific rescue sheet (see the [“The digital Mercedes-Benz rescue assistant”](#) section).

The SOC (state of charge) or the high-voltage battery or individual cells within the high-voltage battery remains unchanged following deactivation of the high-voltage electrical system, but the high-voltage battery is electrically disconnected from the rest of the high-voltage electrical system. In addition to automatic deactivation of the high-voltage electrical system, there is also a manual high-voltage disconnect.

Disabling direct dangers/safety regulations

Manual high-voltage disconnect

Vehicles with high-voltage electrical systems have options for manual deactivation of the high-voltage electrical system. The location and design of the high-voltage disconnect can be found in the vehicle-specific rescue sheet (see the [“The digital Mercedes-Benz rescue assistant”](#) section).

Switch off the drive system before actuation of the high-voltage disconnect (see the [“Switching off the drive system”](#) section).

Example: Mercedes-Benz C-Class vehicle, Type 206

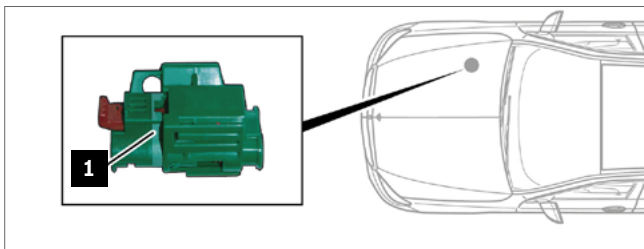

Example: Mercedes-Benz EQE vehicle, Type 295

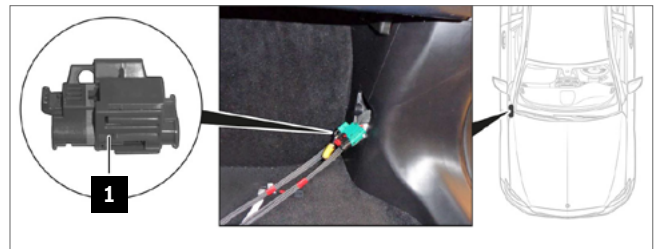

1 High-voltage disconnect

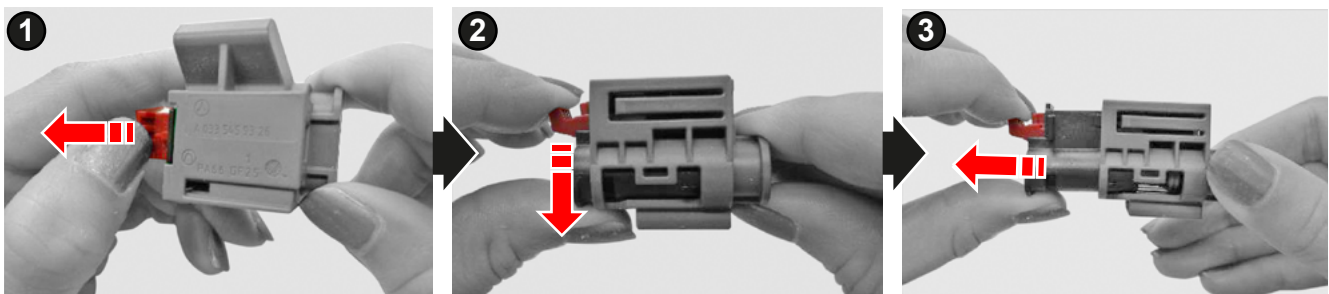

Actuating the high-voltage disconnect (1):

Step 1: Pull the release.

Step 2: Push the release down.

Step 3: Pull out the switch.

Disabling direct dangers/safety regulations

Alternative high voltage device that disconnects high voltage (high-voltage cut point)

Mercedes-Benz vehicles with high-voltage electrical systems have an option for manual deactivation of the high-voltage electrical system. The location of the high-voltage disconnect can be found in the vehicle-specific rescue sheet (see the [“The digital Mercedes-Benz rescue assistant”](#) section).

The alternative high-voltage disconnect should only be actuated if the high-voltage disconnect is not accessible. Switch off the drive system before actuation of the alternative high-voltage disconnect (see the [“Switching off the drive system”](#) section).

Actuating the alternative high-voltage disconnect:

Step 1: Remove the fuse box cover (1).

Step 2: Sever the wire at the two cut point markings (2).

smart vehicles do not have the alternative high-voltage disconnect.

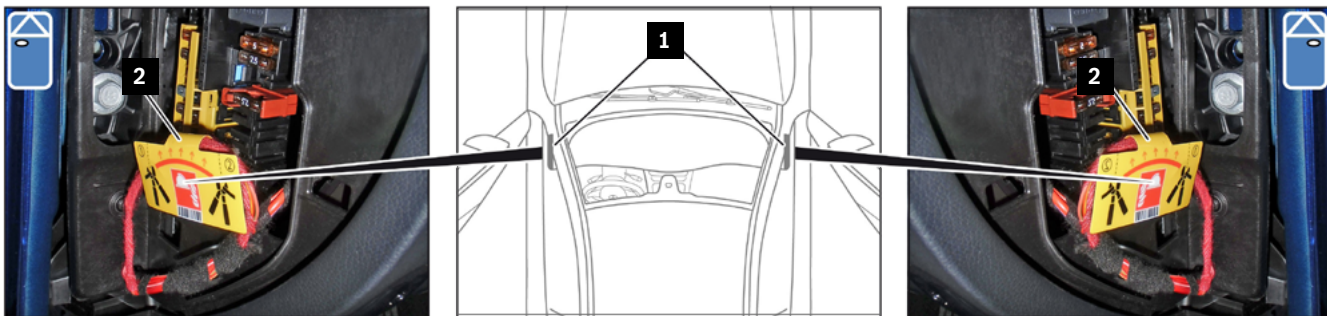

- 1 Fuse box cover
- 2 Cut point marking

Switching off the natural gas system

General warning sign



Risk of explosion owing to leakage of flammable gases or overheating of the gas tank. Risk of injury owing to burns on the skin and eyes. Risk of frostbite to body parts owing to leaking gas and owing to touching components near valves when emptying gas tanks. Risk of poisoning or suffocation owing to breathing in gases.

Eliminate sources of ignition. Wear protective clothing, protective gloves, safety goggles.

Ensure sufficient ventilation. All gas tanks must be removed for work on the vehicle in ambient temperatures of more than 60 °C.

More information on [page 142](#)

Pictograms



Automatic gas overpressure safety valve with gas type indication (CNG)



Flammable

Disabling direct dangers/safety regulations

Automatic deactivation of the natural gas system

If the SRS control unit has detected a major accident and a restraint system has been triggered, then the natural gas and petrol injection system is switched off by the automatic safety cutoff and the gas valves are closed. Every gas tank (1) is equipped with a safety fitting (2). When the vehicle is parked, in petrol mode and in the event of an accident,

the gas tank (1) is automatically locked by the electromagnetic shut-off valve. The safety valve with fuse (effective range $110\text{ °C} \pm 10\text{ °C}$), bursting disk and flow limiter, which can be thermally activated, prevents the gas tank (1) from exploding. In the event of overheating, the gas is released in a controlled manner through tripping of the fuse.

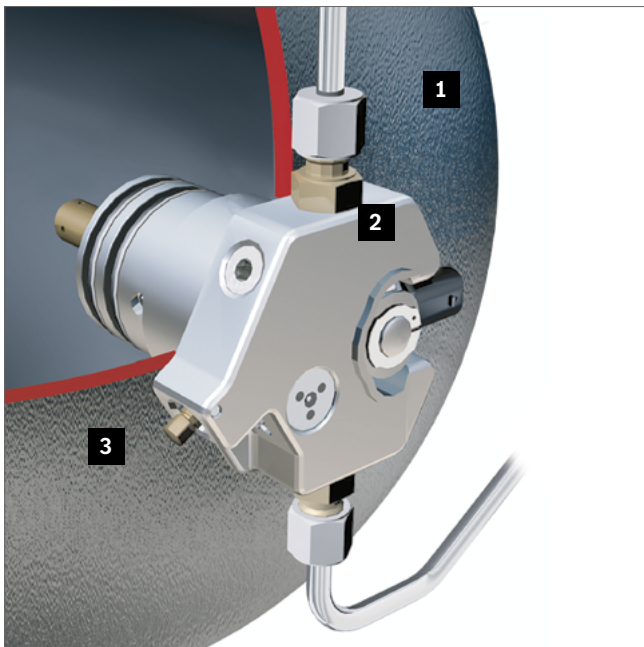

- 1 Gas tank
- 2 Safety fitting
- 3 Shut-off valve

Disabling direct dangers/safety regulations

Gas tanks (1) can be shut off manually if required; this is done by turning the shut-off valve (3) clockwise using a wrench (5 mm). Manual shut-off may be required if the safety solenoid valve is damaged or the fuse is faulty. Since these systems are redundant, the need for manual deactivation is extremely unlikely. The discharge of natural gas may temporarily result in large tongues of flame. These can occur multiple times one after another.

Pay attention to loud hissing noises which are caused by natural gas escaping under high pressure. Fire fighting should generally only begin once the natural gas supply has been inhibited in order to prevent an explosive gas and air mixture from occurring.

Natural gas is generally colourless and odourless. In order to be able to locate leaking natural gas, an aromatic substance is added to it which provides the typical gas smell.

The following should be observed in the event of leaking natural gas:

- Avoid sources of ignition.
- Switch off the engine.
- Measure the gas concentration.
- Allow the natural gas to escape and provide cross ventilation to the greatest extent possible (“blow off” natural gas).
- Use spark-protected tools and explosion-proof equipment.

Note the discharge direction of the gas tank in vehicles which are lying on their side or roof, as controlled tongues of flame may occur when the thermal cutoff is triggered. Conventional fire fighting should only begin after the natural gas has escaped.

If possible, the release of the natural gas should be encouraged through cross ventilation. A gas flame should not be extinguished, as escaping gas can accumulate and ignite again in an explosive manner. However, fires in the surrounding area/resulting fires in the vehicle should be extinguished.

Extinguishing media

Natural gas is classified as fire class C “Gases” in accordance with the European standard EN2 “Flammable materials of various kinds”. All C class extinguishing media, such as ABC powder extinguishers, are possible as extinguishing media.

Switching off the fuel cell system

General warning sign



Risk of explosion owing to leakage of hydrogen or overheating of the fuel tank during operations on the hydrogen system. Risk of frostbite to body parts owing to leaking gas and owing to touching components near components which carry gas when emptying fuel tanks. Risk of suffocation owing to breathing in air diluted with hydrogen. Risk of burns owing to stumbling into an invisible pale blue hydrogen flame.

More information on [page 146](#)

Pictograms



H₂ automatic overpressure valve



Attention: Hydrogen burns with an almost colourless flame



Risk of explosion

Disabling direct dangers/safety regulations

Automatic deactivation of the fuel cell system

In the event of an accident in which the SRS system triggers, the valves on fuel tanks 1 and 2 (see “Overview of fuel tanks”) are automatically closed and the hydrogen supply is therefore stopped. The fuel cell stack is short circuited and is thus discharged. The installation positions of the fuel cell system components which are relevant for the operation can be found in the vehicle-specific rescue sheet (see the [“The digital Mercedes-Benz rescue assistant”](#) section).

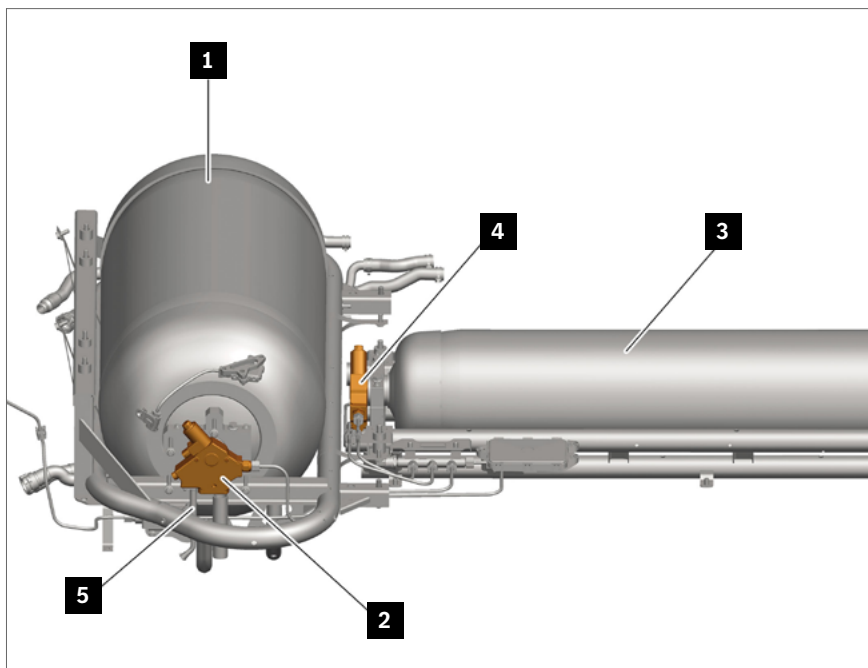

Disabling direct dangers/safety regulations

Manual deactivation of the hydrogen system

Fuel tanks can be shut off manually if required; this is done by turning the shut-off valve at fuel tank valve 1 and fuel tank valve 2 (see “Fuel tank overview”) clockwise using a wrench (SW 7).

Overpressure protection

The hydrogen is stored at a normal pressure of up to 700 bar at a gas temperature of approx. 15 °C. At higher temperatures, the storage pressure can increase to up to 875 bar.

This can occur after refuelling, for example. In the event of a hydrogen pressure regulator malfunction in the fuel system, the overpressure valve in the fuel tank valve (see “Fuel tank overview”) opens and allows the hydrogen to escape into the open air via a drain line (see “Fuel tank overview”). The overpressure valve opens from a pressure of approx. 20 bar.

Overheat protection

An overheat protection device is integrated into the fuel tank valve (see “Fuel tank overview”). The overheat protection prevents the fuel tank from exploding (see “Fuel tank overview”) when exposed to heat. The overheat protection opens at temperatures of > 110 °C and allows the hydrogen to escape in a controlled manner via the discharge line (see “Fuel tank overview”).

With the refuelling hose attached

If the vehicle is still connected to the hydrogen pump, care must be taken to ensure that this is switched off. To this end, contact the filling station operator, for example.

Disabling direct dangers/safety regulations

Fuel tank drain lines

The drain line (5) at fuel tank valve 1 and 2 (see “Fuel tank overview”) is specifically routed downward. The outlet is sealed with a cap (6). A detached cap (6) at the outlet may be an indication that hydrogen was or is being discharged into the open air via the drain line (5). Also pay attention to loud noises of escaping gas (“hissing”) which are caused by hydrogen escaping under high pressure.

The discharge of hydrogen may temporarily result in large tongues of flame. This may occur multiple times one after another. Hydrogen burns with an almost invisible flame. Observe the information regarding the properties of hydrogen in the “[Fuel cell systems](#)” section. Particular care is required before discharging hydrogen in vehicles which are on their roof.

Example: GLC F-CELL drain line (Type 253)

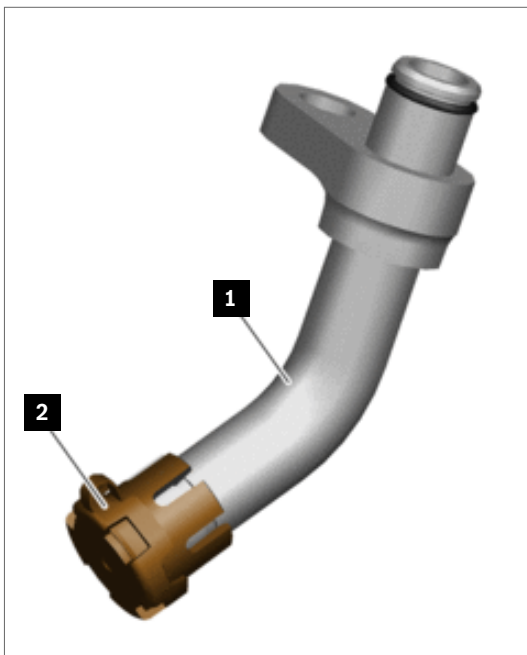

- 1 Drain line
- 2 Cap

4. Access to the occupants

Access possibilities

Opening vehicle windows

In current Mercedes-Benz vehicles, the doors are autonomously unlocked if the SRS control unit has detected an accident event. This unlocking only occurs if neither the battery, nor the electrical cables, the actuators or the locking control unit have been destroyed. In current models, the front and, in specific models, the rear side windows are automatically lowered by approx. 5 cm after triggering of pyrotechnic restraint systems in order to ventilate the interior of the

vehicle. Windows with electric window regulators can be opened with the ignition switched on by pressing the corresponding switch. In some convenience packages, all electric windows can be simultaneously opened by pressing and holding the “Unlock” button on the vehicle key. On some convertibles with an electrically operated roof, this also opens the roof. Older vehicles may still have manual window regulators. These should be opened by turning the winder.

Pictograms



Opening the bonnet



Open the boot lid

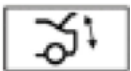

Boot lid convenience closing



Unlock the vehicle



Lock the vehicle

Access to the occupants



- 1 Front left window regulator switch
- 2 Front right window regulator switch
- 3 Back left window regulator switch
- 4 Back right window regulator switch

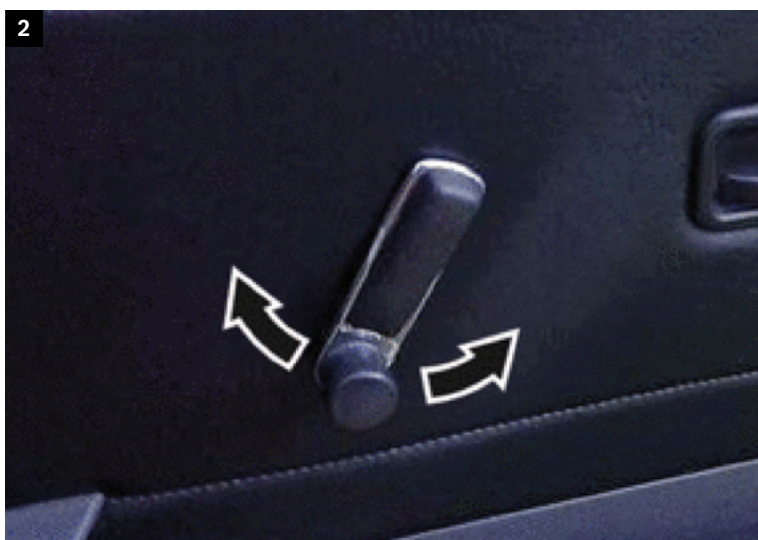

Manual window regulator

Access to the occupants

Unlocking the vehicle doors/boot lid

The vehicle doors and boot lid can be unlocked using the following options:

- Buttons (2, 3) on the vehicle key (1)
- Button/switch on the door panel (5) or at the bottom of the dashboard (7)

Vehicle-specific information can be found in the manual for the vehicle.

In vehicles with boot lid convenience closing, the boot lid is automatically unlocked and opened following actuation of the “Unlock boot lid” button.

Vehicles for the United Kingdom are equipped with an additional door lock. When the additional door lock is activated, the door cannot be opened from inside.

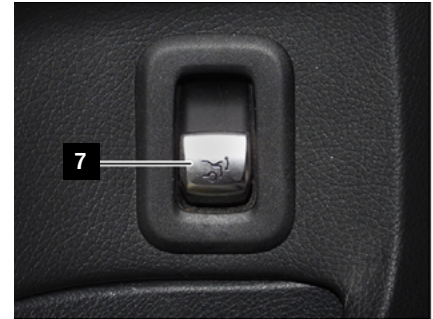
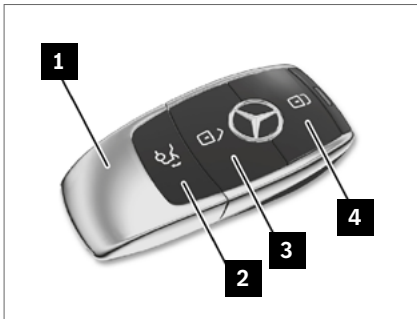

- 1 Vehicle key
- 2 “Unlock boot lid”
- 3 “Unlock vehicle doors”
- 4 “Lock vehicle doors”
- 5 “Unlock vehicle doors” (door panel button block)
- 6 “Lock vehicle doors” (door panel button block)
- 7 “Unlock boot lid” (example at the bottom of the dashboard)

Access to the occupants

Manually unlocking the door from outside

The vehicle door can be unlocked with the emergency key as follows:

- Press the unlock button (2) on the vehicle key (1).
- Remove the emergency key (3).
- Remove the cap (4) from the lock cylinder (5).
- Insert the emergency key (3) into the lock cylinder (5) and turn counterclockwise.

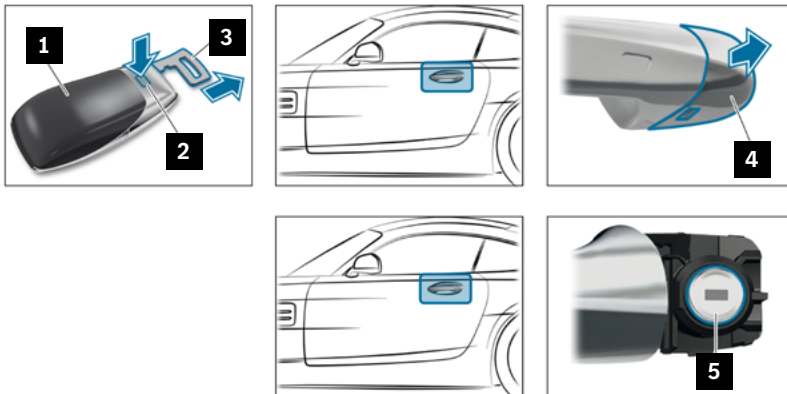

- 1 Vehicle key
- 2 Unlock button
- 3 Emergency key
- 4 Cap
- 5 Lock cylinder

Retractable door handles

In some vehicles, the door handles are recessed flush with the bodywork. These can be manually pulled out

when the central locking is open by pressing on the front area of the door handle.

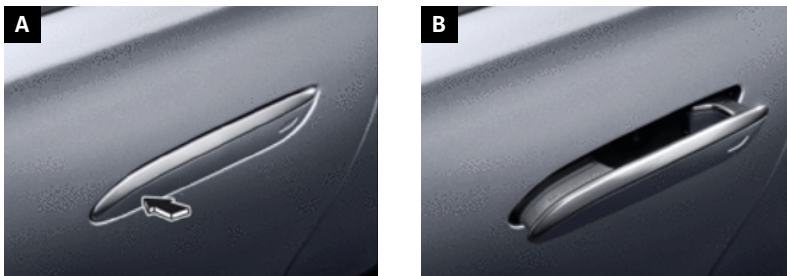

- A Recessed door handle
- B Extended door handle

Bodyshell structures

Mercedes-Benz bodyshell

The type and proportion of the respective materials differ in the individual classes. Structure reinforcements are installed in the A and B pillars in hatchbacks, convertibles and roadsters in particular, because these vehicle types have particularly high stability requirements in these areas.

Material overview in the example of an E-Class saloon (Type 212)

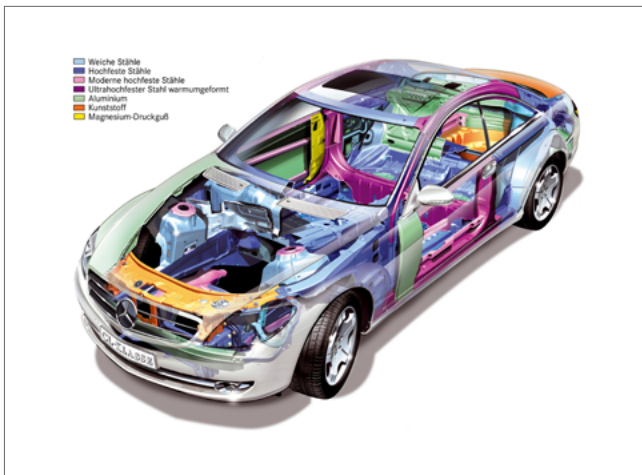

- A Soft steels
- B High-strength steels
- C Modern high-strength steels
- D Ultra high-strength steels
- E Ultra high-strength steels, hot-formed
- F Aluminium
- G Plastic

Material overview in the example of an E-Class saloon (Type 213)

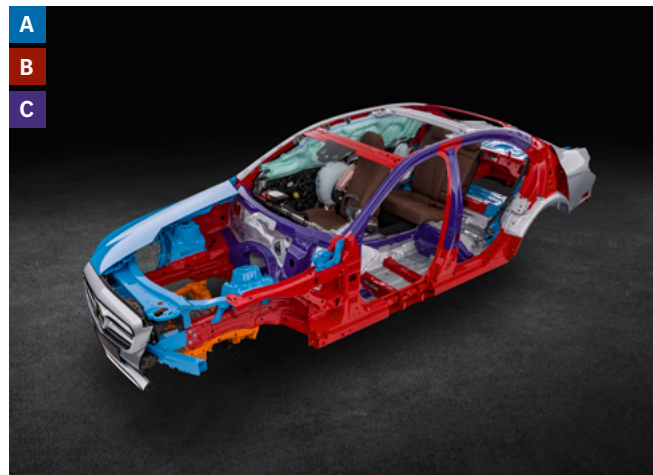

- A Aluminium
- B High-strength steels
- C High-strength, hot-formed steels

Access to the occupants

smart bodyshell

The bodyshell structure has the following characteristics:

- Tridion safety cell with high-strength steels
- Light metal attachment parts

Structure reinforcements are installed in the A pillars. The convertible has roll-over protection in the rear roof frame area. These structure reinforcements are made from martensitic-phase steel, which is particularly high strength and torsion-resistant.

Material overview in the example of a smart fortwo coupé (Type 451)



- A** Microalloyed, high-strength steels
- B** Deep drawing steels with normal strength

Structure reinforcements in lightweight design

Pictograms



Carbon structure

Light and high-strength materials, e.g. magnesium, carbon fibre-reinforced plastic (CFRP), microalloys and high-strength steels, may be used as structure reinforcements. The installation positions of the structure reinforcements which are relevant for the operation can be found in the vehicle-specific rescue sheet (see the [“The digital Mercedes-Benz rescue assistant”](#) section).

Carbon fibre-reinforced plastic (CFRP)

On the strength of past experience, it is possible to cut or deform vehicle structures made from carbon fibre-reinforced plastic (CFRP) with standard rescue equipment. The reciprocating jigsaw is very suitable for cutting CFRP parts.

Cutting CFRP parts generates carbon fibre dust. The personal protective equipment should be adjusted as appropriate for the situation.

CFRP parts and CFRP fibres/dust are electrically conductive. Care must be taken to ensure that the electrical system is disconnected.

Cut zones for rescue personnel

Warning



Risk of injury owing to glass fragments and shards when removing vehicle windows and panoramic roofs. Cover the vehicle occupants. Use personal protective equipment. Remove vehicle windows and the panoramic roof before working on adjacent components.

More information on [page 157](#)

General warning sign



Risk of injury owing to sharp-edged cut surfaces when separating or cutting vehicle parts. Cover sharp-edged cut surfaces with sheets or pillar protection. Use personal protective equipment.

More information on [page 156](#)

Removing vehicle windows

In general, two types of safety glass are used:

- The windscreen is made from laminated safety glass (LSG).
- The rear window and side windows are made from tempered glass (TG) in almost all vehicles. In certain configurations, the side windows are also made from laminated safety glass (LSG).
- In the Mercedes-Maybach (Type 240), all windows are made from laminated safety glass (LSG).

- In the smart fortwo, the panes of the triangular side windows behind the B pillars are made from shatterproof plastic (polycarbonate) and are attached using retaining clips.

Always observe the vehicle-specific rescue sheet: rk.mb-gr.com/de/#rescue-card-selector.

Always identify the prohibited cut zones first. Mark the planned cut locations within the permitted zones.

Access to the occupants

Overview of cut zones

Depending on the accident situation, the roof can be folded forward or back or removed after the appropriate pillars have been severed:

- Cut the A pillar (1) at the bottom wherever possible.
- For A pillars with structure reinforcement (2):
This provides the option of cutting the A pillar free in the roof frame area.
- Cut the B pillar (3) above the belt height adjustment device. B pillar with structure reinforcement (4):
This provides the option of cutting the B pillar at the side by the roof using a V-shaped cut.
- Cut the C pillar (5) at the top wherever possible.
- If the roof is to be folded back: Make a V-shaped relief incision (6) at the back in the middle of the roof.

Always check first whether stored gas inflator for window airbags are installed in the specified cut areas.



- 1 A pillar
- 2 A pillar with structure reinforcement
- 3 B pillar
- 4 B pillar with structure reinforcement
- 5 C pillar
- 6 Relief incision (roof)

Glass management

Warning



Risk of injury owing to glass fragments and shards when removing vehicle windows and panoramic roofs. Cover the vehicle occupants. Use personal protective equipment. Remove vehicle windows and the panoramic roof before working on adjacent components.

More information on [page 157](#)

Laminated safety glass (LSG)

The glass saw (1) or the Halligan tool (3) are particularly suitable for removing panes of laminated safety glass (LSG).

Shatterproof plastic (polycarbonate)

The triangular side windows in the smart fortwo can be pried out with a suitable tool, e.g. a crowbar (6) or Halligan tool (3).

Tempered glass (TG)

Tempered Glass (TG) can be removed with the spring centre punch (5). Mask vehicle windows with adhesive tape (4) first.



- 1 Glass saw
- 2 Reciprocating jigsaw
- 3 Halligan tool
- 4 Adhesive tape
- 5 Spring centre punch
- 6 Crowbar

Vehicle operation

Pictograms



Steering column adjustment



Forward/backward seat adjustment



Seat height adjustment

Adjusting the steering wheel

- Release: Pull the release lever (1) all the way down.
- Adjust the steering wheel height (2).
- Adjust the steering wheel distance (3).
- Locking: Push the release lever (1) all the way up.

Access to the occupants

Adjusting the steering wheel mechanically

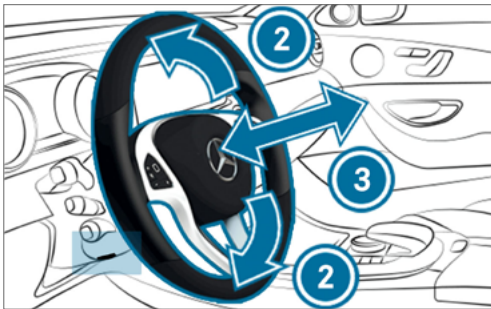

- 1 Release lever
- 2 Adjust the steering wheel height
- 3 Adjust the steering wheel distance

Adjusting the steering wheel electronically

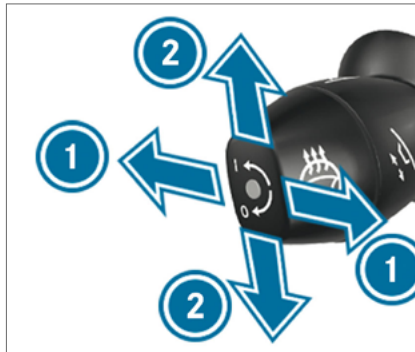
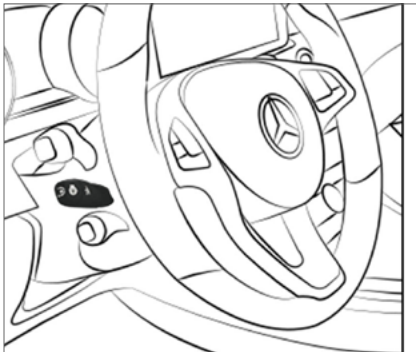

- 1 Adjust the steering wheel distance
- 2 Adjust the steering wheel height

Access to the occupants

Adjusting the seat

Adjusting the steering wheel mechanically/with partial electronic adjustment

The controls may vary depending on the vehicle configuration.

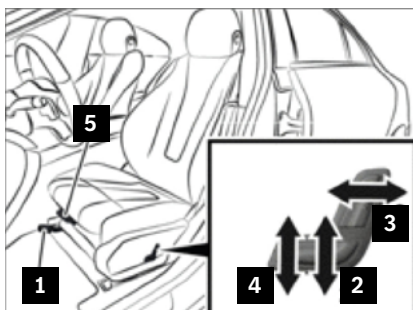
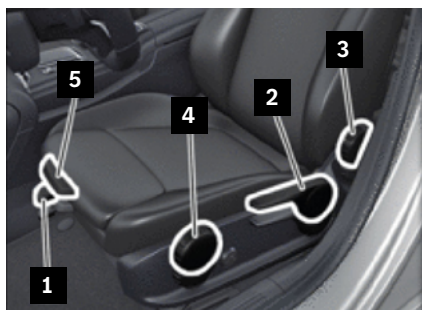

- 1 Forward/backward adjustment
- 2 Seat height adjustment
- 3 Seat back angle
- 4 Seat cushion angle
- 5 Seat cushion depth

Adjusting the seat electronically

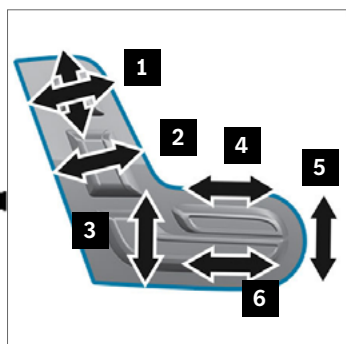
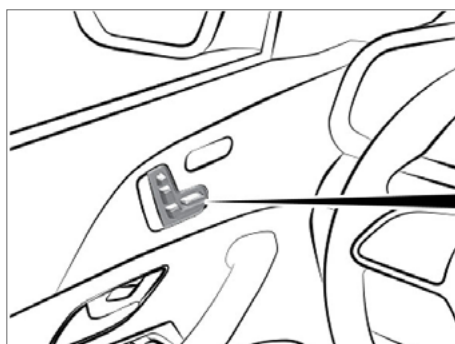

- 1 Headrest adjustment
- 2 Seat back angle
- 3 Seat height adjustment
- 4 Seat cushion depth
- 5 Seat cushion angle
- 6 Forward/backward adjustment

Access to the occupants

Removing the headrest

In certain accident situations, it may be advisable to remove the headrest. Always consult the emergency physician before removal.

Removing a manually operated headrest:

- Pull the headrest up to the stop.
- Press the unlock button (1) and pull the headrest out.

Removing an electronically operated headrest:

- Use the switch to move the headrest to the highest position.
- If possible, pull the headrest out.

It is not possible to remove the headrest from the driver/passenger seat in all Mercedes-Benz vehicles.

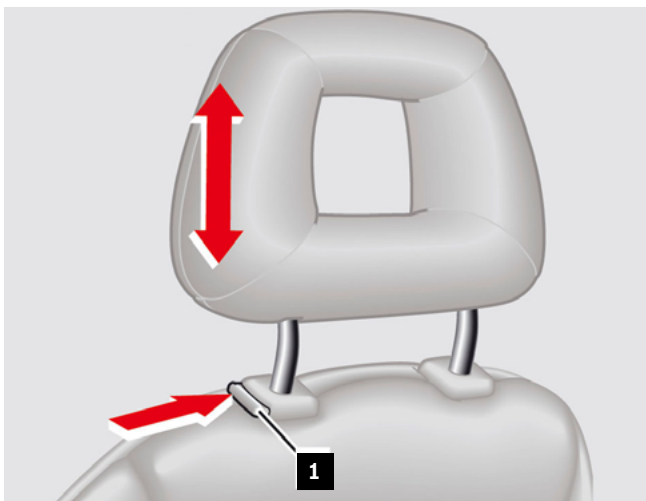

1 Unlock button

Entry and egress assistance

Warning



Risk of injury owing to unintentional movement of the seat or the steering wheel. Disconnect all batteries. If there is a risk of becoming trapped, immediately stop seat adjustment and steering column adjustment.

More information on [page 158](#)

Depending on the vehicle configuration, Mercedes-Benz vehicles are equipped with an entry and egress assistance system. When the ignition is switched off, the steering wheel is moved upward to the stop and the driver's seat is moved back slightly. When the driver's door is closed, the steering wheel and driver's seat are automatically returned to the last adjusted position.

Pictograms



Steering column adjustment



Forward/backward seat adjustment



Seat height adjustment



- 1 Steering column adjustment control lever
- 2 Multifunction steering wheel buttons

Access to the occupants

Switching the entry and egress assistance system on or off:

- With the rotary switch on the steering column adjustment control lever (1)
- In the “CONVENIENCE” submenu in the multimedia system using the multifunction steering wheel buttons (2)

The adjustment process can be halted by one of the following actions:

- Actuating the steering column adjustment control lever (1).
- Actuating the steering column adjustment switch in the button block on the driver’s door (2).
- Actuating the memory function position button (4).

The entry and egress assistance system can no longer be used if the battery is disconnected.

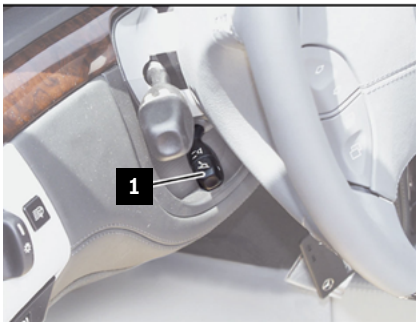

- 1 Steering column adjustment control lever
- 2 Steering column adjustment switch in the button block on the driver’s door
- 3 Seat adjustment switch in the button block on the driver’s door
- 4 Memory function position button

5. Stored energy/liquids/gases/solids

Leaking operating fluids



1



2



3



4



5



6



7



8



9



10



11



12



13



14

- 1 Information concerning operating fluid specifications
- 2 Brake fluid
- 3 Grease
- 4 Transmission oil
- 5 Hydraulic oil
- 6 Coolant
- 7 Compressor oil

- 8 Preserving oil
- 9 Corrosion inhibitor/antifreeze
- 10 Fuel
- 11 Steering gear oil
- 12 Engine oil
- 13 NOx reducing agent
- 14 Windshield washer concentrate

Stored energy/liquids/gases/solids

The installation positions of the components which are relevant for the operation can be found in the vehicle-specific rescue sheet (see the “[The digital Mercedes-Benz rescue assistant](#)” section). A multitude of commercial operating fluids are used in a motor vehicle. Information concerning the operating fluids in Mercedes-Benz and smart vehicles can be found at bevo.Mercedes-Benz.com or in the Mercedes-Benz BeVo app.

Operating fluids:

- Coolant/antifreeze for the engine and/or high-voltage battery
- Lubricants for the engine, transmission, differential
- Brake fluid
- Windshield washer, incl. antifreeze where applicable
- Coolant
- Hydraulic oil for the power steering
- Fuel (petrol/diesel/natural gas/hydrogen)
- NOx reducing agent (AdBlue®)
- Electrolyte in the 12 V battery (diluted sulfuric acid)
- Electrolyte in the Li-ion battery (12 V battery, 48 V battery or high-voltage battery)
- Nitrogen in the pneumatic spring
- Electrolyte in the electromagnetic mirror and the electrochromatic panoramic roof (electrochromic gel)

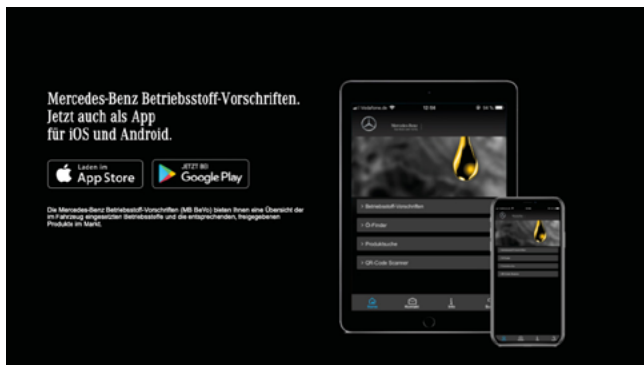

The Mercedes-Benz operating instructions are available at the link bevo.Mercedes-Benz.com and as an app.

Types of voltage and electrical systems

General warning sign



Danger of death when working on components and systems with $U \geq 30$ V AC voltage or $U \geq 60$ V DC voltage. Do not touch damaged or defective live components and cables, as well as electrical connections and cables which are not insulated.

More information on [page 150](#)

High-voltage electrical system

Classification as high-voltage components or high-voltage electrical system in a motor vehicle depends on the type of voltage, namely “AC” or “DC”.

- AC voltage with a supply voltage of more than 30 V
- DC voltage with a supply voltage of more than 60 V

Current classes from Mercedes-Benz and smart are operated with a voltage level of 120-450 V DC.

The basic design of the high-voltage electrical system and the rescue-related information resulting from this are independent of the vehicle type.

Depending on the vehicle, the high-voltage electrical system supplies other units with electrical energy in addition to the electric drive motor, such as the electric coolant compressor (high-voltage components), the high-voltage PTC heating element and the 12-V electrical system.

Stored energy/liquids/gases/solids

12-V electrical system

The conventional 12-volt electrical system for supplying the 12-volt components (e.g. vehicle lighting, control units, convenience systems, etc.) remains unchanged.

The high-voltage electrical system is electrically isolated (insulated) from the ground of the vehicle and the 12-volt electrical system.

48-V electrical system

Increasing numbers of Mercedes-Benz vehicles have a 48-V electrical system installed in addition to the 12-V electrical system (EQ Boost technology). The voltage range used in the 48-volt electrical system is always below the touch voltage limit of 60 V DC voltage.

Certain components may carry high voltage even in a vehicle with no high-voltage battery. These components in the vehicle always have a warning sticker and are designed with touch protection.

An overview of vehicles with alternative drives can be accessed at rk.mk-qr.de/alternative_engines or using the QR code shown.



Information concerning high-voltage batteries

Mercedes-Benz and smart vehicles with a high-voltage electrical system use lithium-ion (Li-ion) battery cells as their high-voltage batteries. Since the high-voltage battery is a safety-related component, this is installed in areas of the vehicle with particular crash protection.

Furthermore, constructional measures (protective housing for the battery with crash profiles and protective frame) are implemented to protect the high-voltage battery against critical deformations and penetration by surrounding components.

Every high-voltage battery has mechanical safety devices

which are triggered in the event of an unusual increase in temperature and pressure inside the battery and thus result in a targeted release of pressure. There are also other safeguards in place to protect high-voltage battery from mechanical damage. Every high-voltage battery has a battery management system (BMS) for monitoring and regulation. The BMS monitors the status of the high-voltage battery in all driving modes. In the event of a major accident or a system error, the BMS disconnects the battery connections and the high-voltage electrical system by opening the contactors.

The high-voltage battery itself remains electrically charged even after the high-voltage electrical system has been switched off and discharged.

Pictograms



Warning, electricity



Corrosive



Respiratory and skin sensitization



Flammable

Stored energy/liquids/gases/solids

Electric vehicle example: Mercedes-Benz EQC vehicle

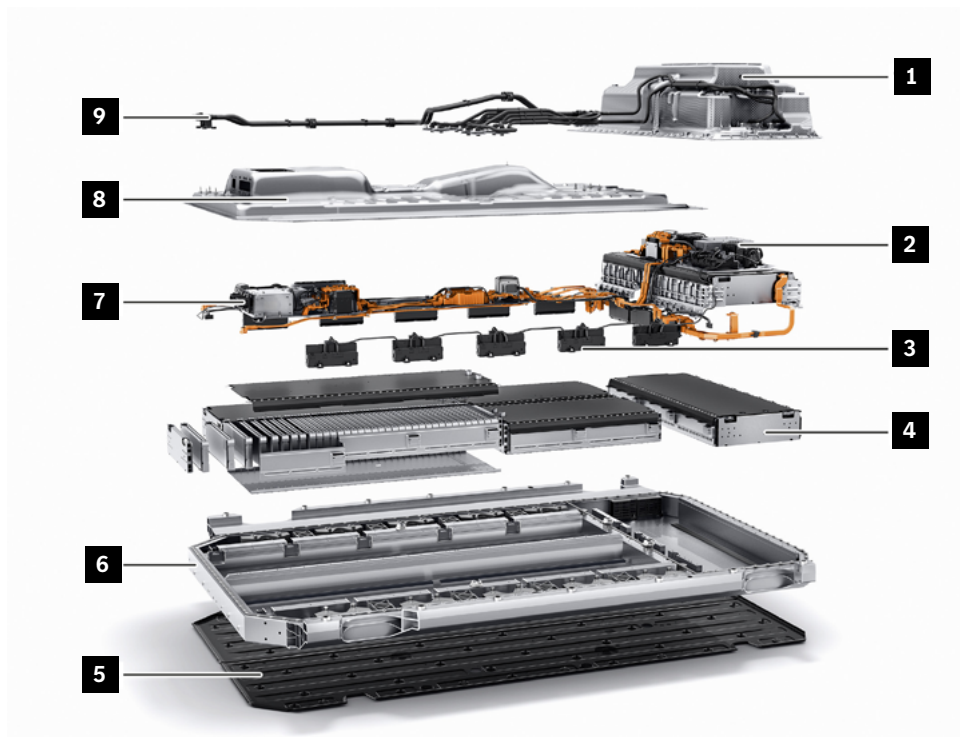

- | | | | |
|---|----------------------------|---|-------------------------------|
| 1 | Top section of the housing | 5 | Underbody panelling |
| 2 | Electrics/electronics | 6 | Bottom section of the housing |
| 3 | Cell monitoring unit | 7 | High-voltage connections |
| 4 | Cell block | 8 | Housing cover |
| | | 9 | Coolant line |

Observe in the event of a damaged high-voltage battery

In the event of a visibly damaged high-voltage battery, an internal short circuit may occur in the lithium-ion cells and the stored chemical energy may be released in an uncontrolled manner in the form of thermal energy. This results in a risk of fire. If a critical temperature is detected in the high-voltage battery, a warning is displayed on the electronic instrument cluster display. This assumes that the 12-V electrical system is intact, the engine is running, or the ignition is switched on. External indications such as smoke or fire do not necessarily need to be apparent in this case. A critical high-voltage battery condition should nevertheless be assumed. The condition of the high-voltage battery should therefore be monitored (e.g. for smoke or a significant increase in the temperature of the high-voltage battery housing in comparison with the ambient temperature) since later spontaneous ignition in lithium-ion batteries cannot be excluded. A fire-fighting method for cooling the high-voltage battery with water should be prepared. Requesting a qualified expert for high-voltage batteries is

recommended in order to make an assessment of the danger and determine the further course of action. This applies both for the entire vehicle which has been involved in an accident or burnt out and for a high-voltage battery which has become separated from a vehicle.

- Battery electrolyte is an irritant, is flammable and is potentially corrosive.
- Use a conventional binding agent.
- Skin contact with the battery electrolyte and breathing in gases which are released as a result of chemical reactions with the leaking battery electrolyte must be avoided at all costs.
- Always adjust the personal protective equipment as appropriate for the situation.
- In the event of contact with the contents of the high-voltage battery or its gases, the affected areas of skin should be rinsed with plenty of water.
- Remove and clean contaminated clothing.
- Consult a doctor as quickly as possible.

Liquids leaking from high-voltage batteries are generally coolant and not battery electrolyte. Battery electrolytes are only present in small quantities (ml) spread across the individual cells.

Stored energy/liquids/gases/solids

In the event of a high-voltage battery without external damage

An internal short circuit may occur in the lithium-ion cells of a high-voltage battery even without external damage and the stored chemical energy may be released in an uncontrolled manner in the form of thermal energy. This results in a risk of fire.

If a critical condition is detected, a warning is displayed on the electronic instrument cluster display. This assumes that the 12-V electrical system is intact, the engine is running, or the ignition is switched on. External indications such as smoke or fire do not necessarily need to be apparent in this case. A critical high-voltage battery condition should nevertheless be assumed.

The condition of the high-voltage battery should therefore be monitored (e.g. for smoke or a significant increase in the temperature of the high-voltage battery housing in comparison with the ambient temperature) since later spontaneous ignition in lithium-ion batteries cannot be excluded. A fire-fighting method for cooling the high-voltage battery with water should be prepared. Requesting a qualified expert for high-voltage batteries is recommended in order to make an assessment of the danger and determine the further course of action. This applies both for the entire vehicle which has been involved in an accident or burnt out and for a high-voltage battery which has become separated from a vehicle.

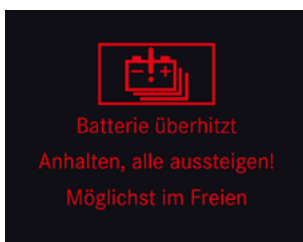

Warning on the electronic instrument cluster display.

Stored energy/liquids/gases/solids

Outgassing of a high-voltage battery

A thermal runaway may begin with outgassing of the battery and ultimately result in a fire. Possible triggers may be:

- Mechanical stress
- Electrical faults
- Thermal influences

If the battery's state of charge is low (less than 30% SOC), then only outgassing occurs. However, these gases can form explosive mixtures which react with a delay.

Leaking gases can generally also be detected by a pungent, acrid smell.

Information concerning high-voltage electrical systems

High-voltage cables

All high-voltage components are connected to one another via a special high-voltage electrical system. High-voltage cables can immediately be recognized by their large cross section and the orange protective sheath and told apart from the cables of the 12-volt electrical system. The connections and plugs on the high-voltage components are designed with touch protection and are also monitored

by a separate signal line (Interlock).

The high-voltage electrical system insulation monitoring constitutes another safety device.

The high-voltage electrical system is switched off and discharged if a significant insulation fault is detected. The high-voltage electrical system is fully electrically insulated from the bodywork.

Pictograms



Warning, electricity



Corrosive



Respiratory and skin sensitization



Flammable

Vehicles with combustion engines (petrol/diesel)

General warning sign



Risk of explosion owing to ignition, risk of poisoning owing to inhalation and ingestion of fuel, and risk of injury owing to skin and eye contact with fuel.

Fire, sparks, open flames and smoking are prohibited. Only pour fuels into suitable and appropriately labelled containers. Wear protective clothing when handling fuel.

More information on [page 152](#)

Pictograms



Vehicle with class 1 fuel
(diesel)



Vehicle with class 2 fuel
(petrol, ethanol, etc.)

Example: E-Class saloon (Type 212)

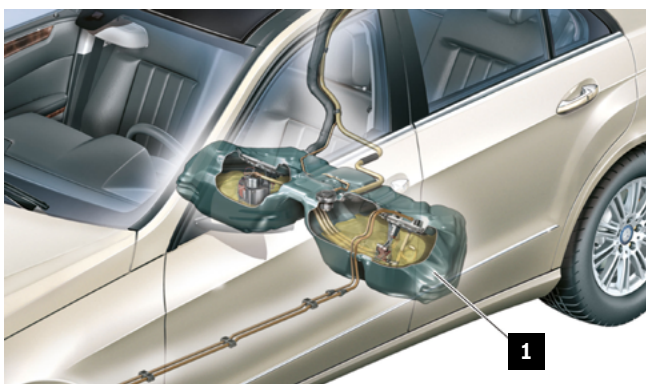

The installation positions of the components of the fuel system which are relevant for the operation can be found in the vehicle-specific rescue sheet (see the [“The digital Mercedes-Benz rescue assistant”](#) section). The fuel tank (1) is located in the area in front of or above the rear axle or under the load compartment floor.

1 Fuel tank

Stored energy/liquids/gases/solids

Properties of fuels

Fuel is a complex mixture of various hydrocarbons. Fuels may also contain low volumes of additives. Diesel may also contain fatty acid methyl ester (FAME). Fuels are highly flammable, toxic and harmful to health. The following should be observed in the event of leaking fuel:

- Avoid sources of ignition.
- Switch off the engine.
- Use an inert binding agent to absorb the fuel and pour it into a suitable disposal container.
- Use spark-protected tools and explosion-proof equipment.

Pictograms



Hazardous to the aquatic environment



Respiratory and skin sensitization



Flammable



Risk of explosion

Vehicles with natural gas engines NGT/NGD (CNG)

General warning sign



Risk of explosion owing to leakage of flammable gases or overheating of the gas tank. Risk of injury owing to burns on the skin and eyes. Risk of frostbite to body parts owing to leaking gas and owing to touching components near valves when emptying gas tanks. Risk of poisoning or suffocation owing to breathing in gases.

Eliminate sources of ignition. Wear protective clothing, protective gloves, safety goggles.

Ensure sufficient ventilation. All gas tanks must be removed for work on the vehicle in ambient temperatures of more than 60 °C.

More information on [page 142](#)

Pictograms



Vehicles fuelled by natural gas



Compressed natural gas (CNG)



Risk of explosion



Warning; low temperature

Natural gas system in the example of a B-Class (Type 245)

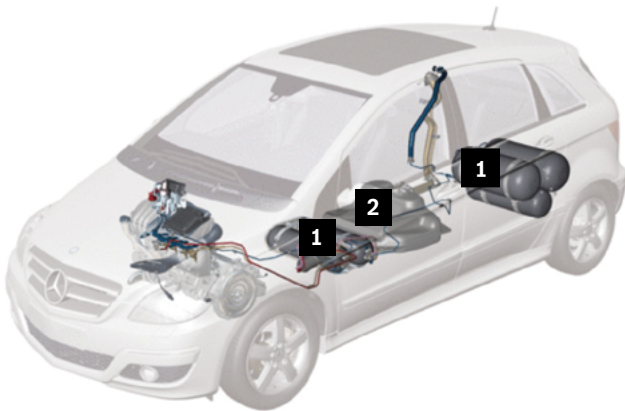

- 1 Gas tank
- 2 Fuel tank (petrol)

The installation positions of the components of the fuel system which are relevant for the operation can be found in the vehicle-specific rescue sheet (see the [“The digital Mercedes-Benz rescue assistant”](#) section). The gas tanks (1) are made from high-strength steel or plastic composite material. The gas tanks (1) may be located in the spare wheel well as well as behind the rear seats in the boot or under the vehicle floor between the front and rear axle.

Switching off the natural gas system

See the [“Switching off the natural gas system”](#) section.

Properties of natural gas

Natural gas is generally colourless and odourless. In order to be able to detect leaking natural gas, an aromatic substance is added to it which is responsible for the typical gas smell. The following should be observed in the event of leaking natural gas:

- Avoid sources of ignition.
- Switch off the engine.
- Measure the gas concentration.
- Allow the gas to escape in a controlled manner and provide cross ventilation where applicable (“blow off” natural gas).
- Use spark-protected tools and explosion-proof equipment.

Vehicles with hybrid drives (HEV)

General warning sign



Risk of fire/explosion owing to short circuit and leaking oxyhydrogen gas. Risk of burns/injury owing to burns to eyes, skin and mucous membranes owing to battery electrolyte/smoke, short circuit and arc exposure. Risk of poisoning owing to swallowing battery electrolyte or absorption of lead through the skin or orifices. Danger of death owing to electric voltages $U \geq 30$ V AC and $U \geq 60$ V DC. Fire, sparks, open flames and smoking are prohibited. Wear acid-resistant gloves, clothing and goggles. Only pour battery acid into suitable and appropriately labelled containers.

More information on [page 139](#)

Pictograms



Hybrid electric vehicles with class 1 fuel (diesel)



Hybrid electric vehicles with class 2 fuel (petrol, ethanol, etc.)

The basic design of the drive train is the same as for a conventional vehicle. The electric drive is coupled with the combustion engine and powered by the high-voltage battery. The high-voltage battery may be located in the engine compartment, under the rear seats, or under the load compartment floor.

The installation positions of the high-voltage electrical system components and electric drive components which are relevant for the operation can be found in the vehicle-specific rescue sheet (see the [“The digital Mercedes-Benz rescue assistant”](#) section).

Vehicles with plug-in hybrid drives (PHEV)

General warning sign



Risk of fire/explosion owing to short circuit and leaking oxyhydrogen gas. Risk of burns/injury owing to burns to eyes, skin and mucous membranes owing to battery electrolyte/smoke, short circuit and arc exposure. Risk of poisoning owing to swallowing battery electrolyte or absorption of lead through the skin or orifices. Danger of death owing to electric voltages $U \geq 30$ V AC and $U \geq 60$ V DC. Fire, sparks, open flames and smoking are prohibited. Wear acid-resistant gloves, clothing and goggles. Only pour battery acid into suitable and appropriately labelled containers.

More information on [page 139](#)

Pictograms



Hybrid electric vehicles with class 1 fuel (diesel)



Hybrid electric vehicles with class 2 fuel (petrol, ethanol, etc.)

The basic design of the drive train is the same as for a conventional vehicle. The electric drive is coupled with the combustion engine and powered by the high-voltage battery. The high-voltage battery may be located in the engine compartment, under the rear seats, or under the load compartment floor.

The installation positions of the high-voltage electrical system components and electric drive components which are relevant for the operation can be found in the vehicle-specific rescue sheet (see the [“The digital Mercedes-Benz rescue assistant”](#) section).

Stored energy/liquids/gases/solids

Example: C-Class plug-in HYBRID, Type 205

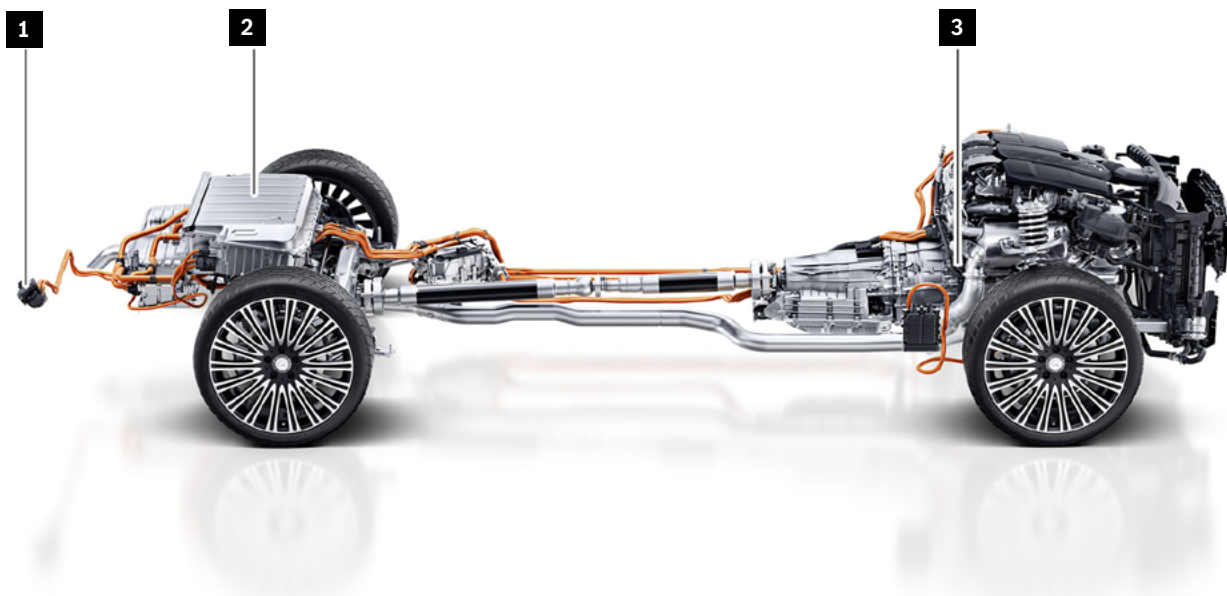

- 1 Charging current supply socket
- 2 High-voltage battery
- 3 Electric drive

Vehicles with electric drives (BEV)

General warning sign



Risk of fire/explosion owing to short circuit and leaking oxyhydrogen gas. Risk of burns/injury owing to burns to eyes, skin and mucous membranes owing to battery electrolyte/smoke, short circuit and arc exposure. Risk of poisoning owing to swallowing battery electrolyte or absorption of lead through the skin or orifices. Danger of death owing to electric voltages $U \geq 30$ V AC and $U \geq 60$ V DC.

Fire, sparks, open flames and smoking are prohibited. Wear acid-resistant gloves, clothing and goggles. Only pour battery acid into suitable and appropriately labelled containers.

More information on [page 139](#)

Pictograms



Electric vehicle

All of the drive power is generated by one or more electric motors. The electric drive is powered by the high-voltage battery (3). In an electric vehicle, the high-voltage battery (3) is generally located in the underbody area of the vehicle. The installation positions of the high-voltage electrical system

components and electric drive components which are relevant for the operation can be found in the vehicle-specific rescue sheet (see the "[The digital Mercedes-Benz rescue assistant](#)" section). More information concerning high-voltage components can be found in the "[High-voltage components](#)" section.

Stored energy/liquids/gases/solids

Example: EQC, Type 293

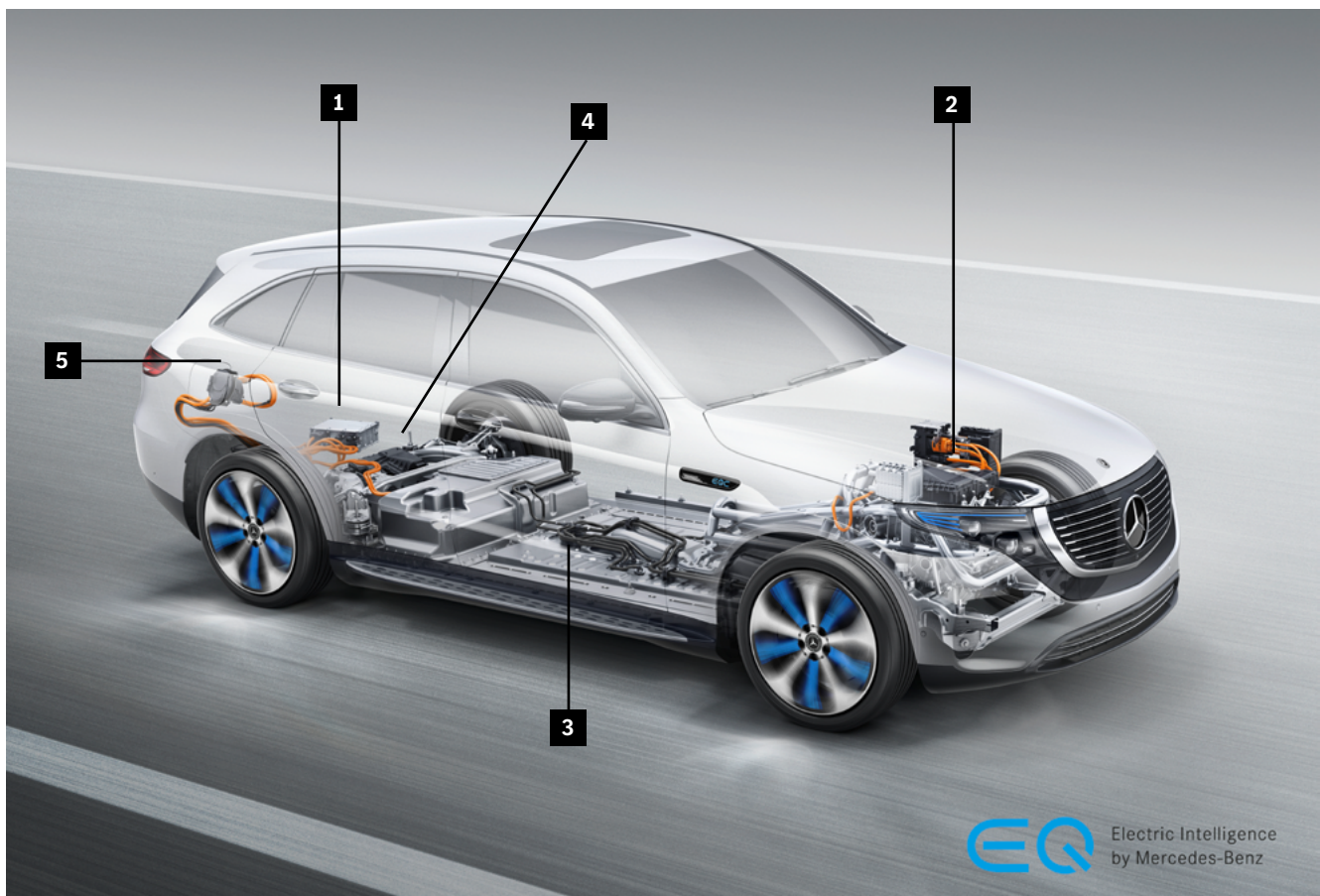

- | | |
|---|--|
| 1 Charger | 4 Rear electric axle drive module |
| 2 Front electric axle drive module | 5 Charging current supply socket |
| 3 High-voltage battery | |

Vehicles with fuel cell systems (F-CELL)

General warning sign



Risk of explosion owing to leakage of hydrogen or overheating of the fuel tank during operations on the hydrogen system. Risk of frostbite to body parts owing to leaking gas and owing to touching components near components which carry gas when emptying fuel tanks. Risk of suffocation owing to breathing in air diluted with hydrogen. Risk of burns owing to stumbling into an invisible pale blue hydrogen flame.

More information on [page 146](#)

Pictograms



Vehicle with fuel cell system

All of the drive power is generated by one or more electric motors. In addition to the high-voltage battery (2) and the electric motor (5), the fuel cell component supplies electrical energy to all high-voltage components and the 12-volt electrical system. The carbon fibre-reinforced hydrogen fuel

tanks (6) are located under the vehicle floor between the front and rear axle. The fuel cell stack is the energy converter which generates electrical energy through an electrochemical process with the help of oxygen from the ambient air and the hydrogen stored in the fuel tanks.

Stored energy/liquids/gases/solids

Example: GLC F-CELL, Type 253

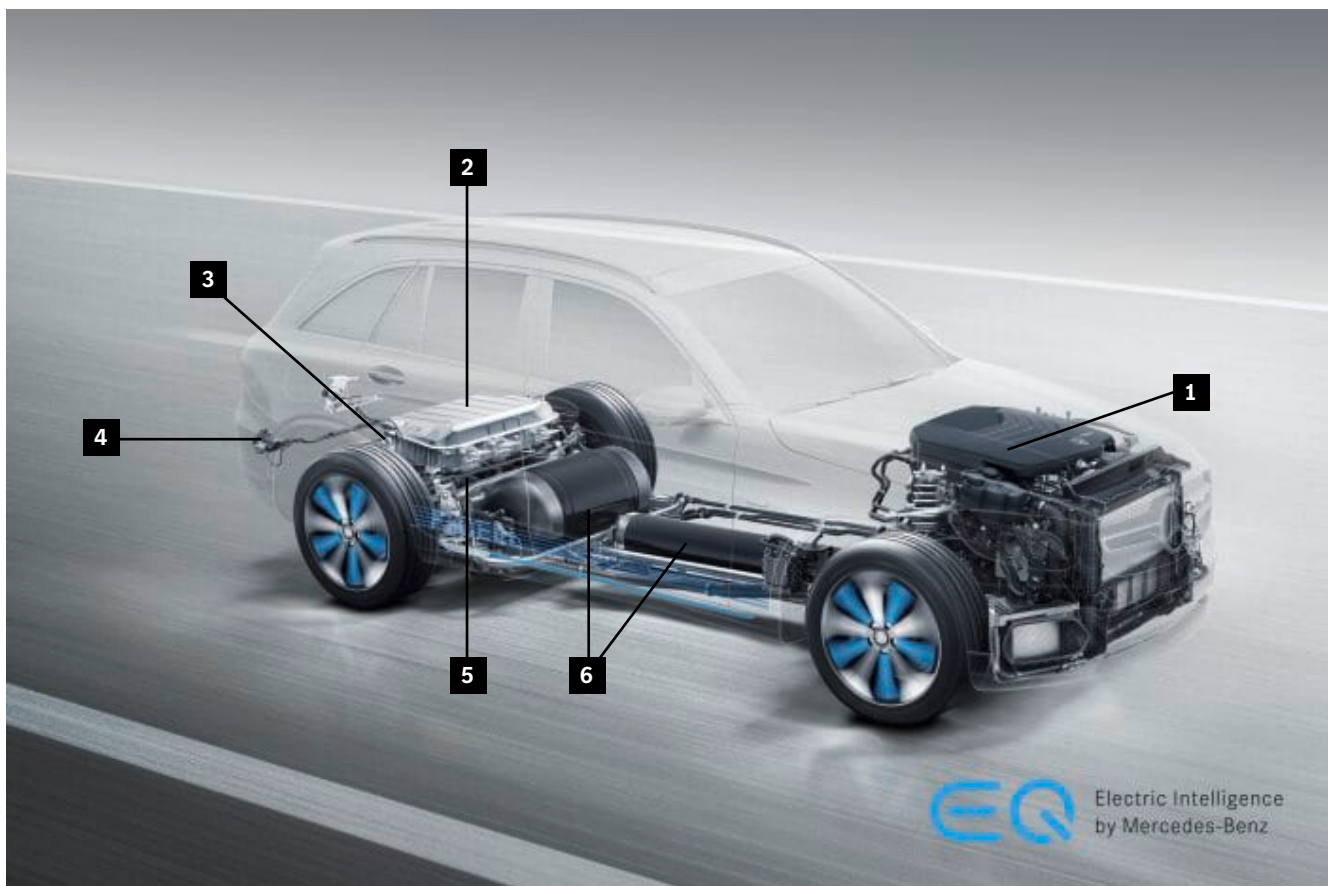

- 1 Fuel cell system with fuel cell stack
- 2 High-voltage battery
- 3 Charger

- 4 Charging current supply socket
- 5 Electric motor
- 6 Hydrogen fuel tank

Stored energy/liquids/gases/solids

Switching off the fuel cell system

See the [“Switching off the fuel cell system”](#) section. The installation positions of the high-voltage electrical system components and electric drive components which are relevant for the operation can be found in the vehicle-specific rescue sheet (see the [“The digital Mercedes-Benz rescue assistant”](#) section).

Pictograms



Vehicle with fuel cell system



Attention: Hydrogen burns with an almost colourless flame



Compressed gas



Flammable



Risk of explosion

Stored energy/liquids/gases/solids

Properties of hydrogen

Hydrogen gas has a density of approx. 0.09 kg/m³ under standard conditions and is therefore lighter than air.

When mixed with air, hydrogen forms a flammable mixture in ranges from 4% by volume to 77% by volume. This mixture is flammable to a dilution of less than 4% by volume of hydrogen.

Leaking hydrogen gas is not odourized and is therefore entirely odourless and colourless. Hydrogen burns with an almost invisible flame. Before commencing rescue operations, ensure that the high-voltage electrical system and the fuel system (H₂ system) are deactivated. The following must be observed in the event of leaking hydrogen gas:

- Avoid sources of ignition.
- Measure the hydrogen concentration where possible.
- Allow the hydrogen to escape in a controlled manner.
- Use spark-protected tools and explosion-proof equipment.

6. In case of fire

Information to be observed in case of fire

In the event of motor vehicle fires, fumes which are harmful to health may occur owing to the various burning materials and operating fluids. In general, caution should be exercised in the event of fires because plastics, composites and liquids can emit toxic fumes at high temperatures and plastics become capable of forming drops at certain temperatures which are not uncommon in vehicle fires. Vehicles with automatic transmission can be moved in the “N” gearbox setting and with the parking brake released.

Care must be taken here to ensure that the vehicle does not roll away in an uncontrolled manner. In order to engage the “N” gearbox setting, the ignition must be switched on and the brake pedal must be actuated (see the [“Securing the vehicle against rolling away”](#) section). Extinguish vehicle fires in accordance with the fire brigade’s guidelines. Water has proved to be a suitable coolant and extinguishing medium, but specific extinguishing media which correspond to the fire class of the burning medium should be used.

General warning sign



Risk of electric shock in a vehicle fire. Observe safe distances during fire fighting. Carry out fire fighting measures with personal protective equipment and self-contained breathing apparatus. Avoid touching damaged areas. Cover damaged parts with a suitable cover.

More information on [page 159](#)

Warning



Risk of injury to skin and eyes owing to handling of hot or smouldering surfaces.
Risk of fire in the event of contact between smouldering surfaces and flammable materials.
Wear protective gloves, protective clothing and safety goggles where necessary.
Avoid contact between flammable material and smouldering surfaces.

More information on [page 154](#)

In case of fire

Fire classes in accordance with DIN EN 2

Fire class A

Solid matter fires, usually of organic origin, which normally cause glowing fires, e.g. wood, paper, straw, textiles, coal, car tyres.

Fire class B

Fires involving liquids or materials which become liquid, e.g. petrol, benzene, oils, varnishes, tar, ether, alcohol, stearin, paraffin.

Fire class C

Gas fires, natural gas, LPG and hydrogen, should be left to burn out in a controlled manner as extinguishing promises little if any success.

Fire class D

Metal fires, e.g. aluminium, magnesium, lithium, sodium, potassium and their alloys.

Metal fires, e.g. magnesium fires, cannot be extinguished with water or CO₂ extinguishers, these substances accelerate the reaction and explosive oxyhydrogen gas can also be produced.

Always adjust the personal protective equipment as appropriate for the situation (energy storage system). Observe the information in the [“Stored energy/liquids/gases/solids”](#) section.

Petrol/diesel vehicles

Pictograms



Vehicles with class 1 fuel
(diesel)



Vehicles with class 2 fuel
(petrol, ethanol, etc.)



Risk of explosion



Extinguish with ABC powder

Extinguishing media

Petrol and diesel are classified as fire class B “Liquids or materials which become liquid” in accordance with the European standard EN2 “Flammable materials of various kinds”. All B class extinguishing media such as ABC powder extinguishers are possible as extinguishing media.

More information

The installation positions of the components of the fuel system which are relevant for the operation can be found in the vehicle-specific rescue sheet (see the [“Rescue sheets”](#) section).

Recommendation for fire fighting

- Blow in CO₂
- Prevent ventilation
- Suffocate the fire

Vehicles fuelled by natural gas

Pictograms



Vehicles fuelled by natural gas



Risk of explosion



Compressed gas



Extinguish with ABC powder

Extinguishing media

Natural gas is classified as fire class C “Gases” in accordance with the European standard EN2 “Flammable materials of various kinds”. All C class extinguishing media, such as ABC powder extinguishers, are possible as extinguishing media. Fire fighting should only begin once the natural gas supply has been inhibited in order to prevent an explosive gas and air mixture from occurring. In some circumstances, a controlled burn should be considered.

More information

Information concerning automatic deactivation of the natural gas system can be found in the [“Switching off the natural gas system”](#) section.

The natural gas system generally works at a pressure of up to 260 bar.

Electric vehicles

Pictograms



Electric vehicle



Flammable



Risk of explosion



Corrosive



Respiratory and skin sensitization

Extinguish a vehicle fire in which the high-voltage battery is not affected using the typical fire fighting measures for a vehicle fire in accordance with the fire brigade's guidelines. Owing to its material components, a high-voltage battery (lithium-ion battery) is always flammable. Safety is further improved through additional constructional measures on the high-voltage battery housing and the installation location of the high-voltage battery. Owing to these safety measures,

no increased fire risk is expected in comparison with conventional vehicles. The high-voltage battery as a whole and the individual battery cells have mechanical safety devices which are triggered in the event of an increase in temperature and pressure in the high-voltage battery (e.g. caused by a fire) and contribute to targeted venting and therefore pressure release. A high-voltage battery explosion is therefore almost impossible.

More information

The installation positions of the high-voltage electrical system components which are relevant for the operation can be found in the vehicle-specific rescue sheet (see the "[The digital Mercedes-Benz rescue assistant](#)" section).

Additional, general information concerning the

handling of high-voltage vehicles which have been involved in an accident can be found in the "Rescue and Towing of Vehicles with High-Voltage and 48-Volt Systems" VDA brochure. The current version can be found on the VDA homepage under [Rescue and Towing of Vehicles with High-Voltage Systems - VDA](#).

In case of fire

Burning/outgassing high-voltage battery

An outgassing high-voltage battery results in an acute risk of fire. The resulting fumes contain toxic and corrosive components such as low volumes of hydrofluoric acid. The following measures should therefore be observed:

- Adjust the personal protective equipment as appropriate for the situation.
- The use of self-contained breathing apparatuses is required for work in the exposed location.
- The use of water spray to suppress the vapours and gases is indicated.

In the event of a fire in a hybrid/electric vehicle, it is possible that the high-voltage battery may also be ignited owing to prolonged heat exposure, for example. In principle, water is also most suitable as an extinguishing medium in this case. Depending on the battery type, it may not be possible to fully extinguish a burning high-voltage battery; it may continue to reignite until it has burned out on its own. In this case, the high-voltage battery should be cooled through constant dousing with water until the fire no longer spreads and controlled burn-out is possible.

Exposed, defective cells exploding with an accompanying exothermic reaction cannot be excluded.

In case of fire

Extinguishing media

In principle, any available extinguishing medium can be used.

Where possible, plenty of water should be used for extinguishing (approx. 100 l/min).

The high-voltage battery (lithium-ion battery) can be sufficiently cooled through constant dousing with water so that the fire does not spread.

Pictograms



Electric vehicle



Use water to extinguish the fire



Access to the high-voltage battery

Recommendation for fire fighting

If the metal housing of the high-voltage battery is closed:

- Object temperature up to 80 °C: No measures, continue to observe for increasing temperature
- Object temperature greater than 80 °C: Extinguish (cool) with plenty of water from a safe distance

If the metal housing of the high-voltage battery is open:

- Extinguish (cool) with plenty of water from a safe distance

Where possible, move the vehicle or battery to a safe, outdoor location (observation site). Allow the high-voltage battery to burn out in a controlled manner to the greatest extent possible, while preventing the fire from spreading.

Information concerning the handling of a damaged high-voltage battery can be found in the [“Information concerning high-voltage batteries”](#) section.

Vehicles with fuel cell systems

Pictograms



Vehicle with fuel cell system



Risk of explosion



Compressed gas



Extinguish with ABC powder

Gaseous hydrogen is stored at a pressure of up to 700 bar in the fibre-reinforced fuel tanks. Information concerning automatic deactivation of the fuel cell system can be found in the [“Switching off the fuel cell system”](#) section. The installation positions of the fuel cell system components which are relevant for the operation can be found in the vehicle-specific rescue sheet (see the [“The digital Mercedes-Benz rescue assistant”](#) section).

Extinguishing media

Hydrogen is classified as fire class C “Gases” in accordance with the European standard EN2 “Flammable materials of various kinds”. All C class extinguishing media such as ABC powder extinguishers are possible as extinguishing media. Fire fighting should only begin once the hydrogen supply has been inhibited in order to prevent an explosive gas and air mixture from occurring.

Recommendation for fire fighting

If leaking hydrogen is burning, extinguishing the hydrogen flame may result in an accumulation of hydrogen. There is a risk of a subsequent explosion. If automatic deactivation of the fuel cell system does not work ([“Switching off the fuel cell system”](#) section), leave the hydrogen flame to put itself out. You should simply prevent the fire from spreading and ensure that the hydrogen burns out in a controlled manner. Use large volumes of water, particularly on the vehicle floor between the front and rear axle, in order to cool the fuel tank.

7. In the event of submersion in water

Observe for vehicles in water

In principle, when recovering vehicles that are partly or completely submerged in water, there is no difference between conventional vehicles and vehicles that have a high-voltage on-board electrical system. Essentially, there is no risk of electrical shock from the high-voltage on-board electrical system when surrounded by water.

Leaving the vehicle in an emergency **- Respond immediately**

In any emergency all vehicle occupants should leave the vehicle as quickly as possible, particularly in the following situations:

- The vehicle is in danger of sinking into deep water.
- The vehicle is in danger of being flooded.
- In the event of a fire in the vehicle, recognizable through the smell of burning or smoke development, for example.

Keep calm and enact the following measures. Ask other passengers to do the same:

- Take off your seat belt.
- Open the door as quickly as possible. If the next-nearest door cannot be opened, try another door.
- Leave the vehicle immediately.
- If necessary, assist other passengers in leaving the vehicle. Assistance may be necessary, especially where dependents, such as small children, are involved.

Leave the vehicle through any available emergency exit

Emergency exits include, e.g. side windows or the sliding sunroof.

- If the door will not open, open the side window immediately.
- Vehicles with sliding sunroof: Open the sliding sunroof too.
- Leave the vehicle through an available emergency exit.

Please note that a person's ability to leave the vehicle through an available emergency exit may not be possible because of the seat position or physical objects.

In an emergency, break the side windows or rear window

Before doing anything, observe the following information about the structure of the side windows and windows:

- You cannot use an emergency hammer to break side windows and windows made of laminated glass.
- In an emergency, you will not be able to use an emergency hammer to break through side windows and windows made of laminated glass to create an emergency exit.
- You can identify side windows and rear windows made of laminated glass by the XI marking.



1 Marking for laminated glass (example)

Observe for vehicles in water

- If an emergency hammer is available in the vehicle, break the side windows or rear window using the emergency hammer.
- The middle of a pane of glass is the ideal position on a side window or a rear window to apply blows using the emergency hammer to ensure that the single-layer safety glass is broken.
- Leave the vehicle through an available emergency exit.

Vehicles equipped with heat-insulating, sound-dampening and infrared-reflecting laminated glass: Almost all the windows and side windows are made of laminated glass and cannot be broken using an emergency hammer.

The glass sliding sunroof cannot be broken with an emergency hammer in an attempt to escape. Combinations with laminated glass may be installed here. A glass sliding sunroof cannot be broken using an emergency hammer. There is no marking for the type of glass used.

The windshield is always made of laminated glass, irrespective of any markings on it.

Information on what to do when a vehicle is sinking or submerged

If it is not possible to exit the vehicle through the doors or an available emergency exit, take the following measures. Ask other passengers to do the same:

- Wait until the vehicle has sunk to the point that the water level inside the vehicle is almost identical to the water level outside the vehicle.
- The water pressure inside and outside the vehicle is then evenly balanced.
- Open the door. You will need more force than usual.
- If the next-nearest door cannot be opened, try another door.
- Leave the vehicle.

Warning



Risk of injury when using the emergency hammer. You can injure yourself when breaking the windows using the emergency hammer:

- through splinters of glass flying around
- through splinters of glass lying around
- on glass residue left within the window seal

Measures:

- Always protect the skin and eyes using, e.g. a piece of clothing.
- Take particular care that, when under water, the water pressure may cause splinters of glass to be ejected into the vehicle interior.
- Be very careful when leaving the vehicle through a broken window.

Further information is available on [page 157](#)

Observe for vehicles in water

Recover the partly or fully submerged vehicle in accordance with fire department policies. Pull the vehicle as far as possible out of the water. Secure the vehicle and render the vehicle inoperative before continuing with rescue measures.

Positioning and fastening points are described in the Chapter „[Immobilization/stabilization](#)“. Always wear personal protective equipment appropriate for the given situation. Observe the information in the Chapter „[Stored energy/liquids/gases/solids](#)“.

Pictograms



Hazardous to water



Danger of voltage

Warning



Risk of fire through short circuit in a vehicle partly or completely submerged in water. Ensure the ignition is switched off. Where possible, disconnect the 12 V on-board electrical system batteries and disconnect the high-voltage on-board electrical system using the (alternative) high-voltage disconnect device.

Further information is available on [page 160](#)

Environmental hazard

Observe the information in the Chapter „[Leaking operating fluids](#)“.

Risk of groundwater contamination and hazardous effect on aquatic organisms. Fuels and operating fluids may be harmful to the environment.

Vehicles with high-voltage on-board electrical system

Basic information

During the product creation phase, all relevant standards and specifications for vehicle safety were observed such as, for example, ISO 20653 "Road vehicles - Degrees of protection (IP code) — Protection of electrical equipment against foreign objects, water and access"

This strives to achieve the widest-possible degree of protection and safety in the event of a vehicle being submerged in water.

The basic information on [page 108](#) applies here.

After the vehicle has been recovered from the water, the high-voltage on-board electrical system should be deactivated in accordance with the specified shutdown procedure (see Chapter [„Switching off the high-voltage electrical system“](#)). When deactivating the high-voltage on-board electrical system on vehicles recovered from water, suitable personal protective equipment must be worn, e.g. safety mask and insulated gloves, protection class 0.

The high-voltage battery is usually located on the vehicle underbody. When using rescue equipment, care must be taken to ensure that the high-voltage battery is not damaged.

Information on handling a damaged high-voltage battery is available in the Chapter [„Towing/transportation/storage“](#).

Further information on the towing and recovery of vehicles equipped with electric drives is available in the "Guide for car breakdown recovery services for vehicles with electric drives".

Possible scenarios for vehicles in water

There is a difference between vehicles that are partly submerged in water and those that are completely submerged in water. Consider whether the stretch of water is still/calm water or whether it is flowing water.

Submersion in water – Scenario 1

Vehicle submerged in water, water level up to lower edge of body (contact through splash water or a bow wave not excluded)

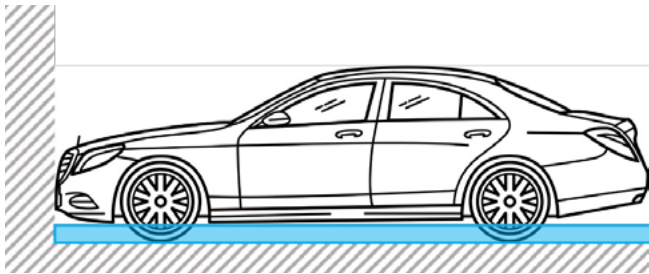

Leave the vehicle immediately in the event of accidents, issues or emergencies described on [page 106](#)!

In this scenario (no accident, no noticeable problems with the vehicle, in a calm stretch of water), the high-voltage components have minimal or no contact at all with the water. Waves or currents may however mean that contact is made temporarily.

If there are no noticeable problems with the vehicle, you can assume that there is no increased risk through and to the high-voltage on-board electrical system. Always observe the information on driving through stretches of water for the respective model series as provided in the Owner's Manual for the vehicle.

After or during passage through water or after contact with water, observe any messages in the driver display and visit a workshop if necessary.

If the high-voltage on-board electrical system is involved in an accident or if it is damaged, there is a potential danger or increased potential danger because water could ingress into the high-voltage battery or the high-voltage on-board electrical system. Water that ingresses into the high-voltage battery may cause an internal short circuit.

Possible scenarios for vehicles in water

Submersion in water – Scenario 2

Vehicle in water, water level up to lower edge of window panes and windows (partly submerged vehicle)

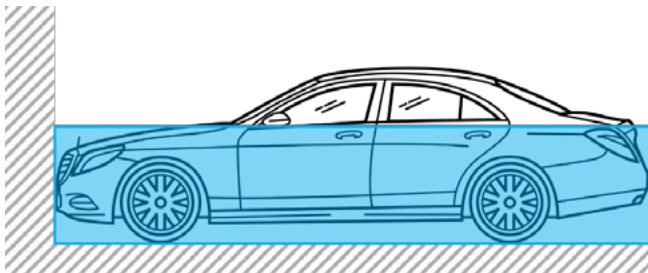

Leave the vehicle immediately in the event of accidents, issues or emergencies described on [page 106](#)!

In this scenario, the high-voltage components are in contact with the water. Provided the high-voltage on-board electrical system has not been in an accident or does not have any noticeable problems, high-voltage components are protected so as to prevent increased electrical danger as long as the high-voltage on-board electrical system is not exposed to this scenario for longer than 30 minutes.

This time period can be significantly reduced in the event of an accident or damage to the high-voltage on-board electrical system. Additionally, the likelihood that water could ingress into the high-voltage battery increases. Water that ingresses into the high-voltage battery may cause an internal short circuit.

In the event of an accident, an automatic high-voltage shutdown is activated if the accident severity is high enough. This disconnects the high-voltage on-board electrical system from the battery to reduce any risk of electric shocks. However, it is still theoretically possible to access active high-voltage component parts despite the high-voltage disconnect device in the event of an accident involving damage to the high-voltage battery.

This harbors the potential risk of an electric current passing through the body or a thermal reaction occurring within the high-voltage battery.

As the water level increases, the likelihood that water could ingress into the high-voltage battery also increases. Water that ingresses into the high-voltage battery may cause an internal short circuit.

Where possible, deactivate the high-voltage on-board electrical system using the specified high-voltage disconnect device or using the alternative high-voltage disconnect device. Do not touch any damaged high-voltage lines (line color: orange). [Page 45 ff.](#)

Pay attention to anything happening below the vehicle (noise, hissing etc.), smoke, or messages shown on the driver display, to identify any damage to or reaction of the high-voltage battery.

If uncertain, try to recover the vehicle from the water and then, if you have not done so already, secure the vehicle electrically using the specified high-voltage disconnect device or the alternative high-voltage disconnect device. If you suspect that water may have ingressed into the high-voltage battery, then avoid tilting or rocking the vehicle as much as possible during recovery and transportation of the vehicle.

Note that any water that has ingressed into the high-voltage battery can also lead to a thermal reaction at a later stage. This should be taken into consideration for transportation and storage of the vehicle.

Possible scenarios for vehicles in water

Submersion in water – Scenario 3

Vehicle in water, water level above roof line (vehicle completely submerged)

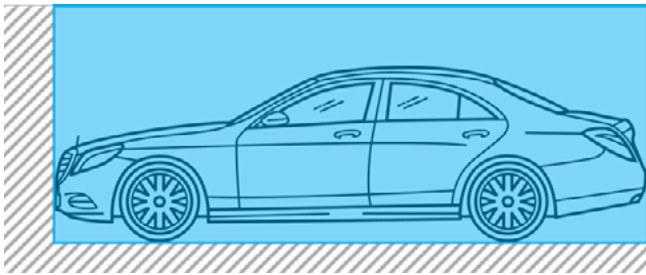

Leave the vehicle immediately in the event of accidents, issues or emergencies described on [page 106!](#)

In this scenario, the high-voltage components are in contact with the water. In this scenario, there is a potential danger of water ingressing into the high-voltage on-board electrical system because of the prevailing influencing factors, such as the level of the water column (water pressure), time below the water, a still or strongly flowing stretch of water.

As the water level increases, the likelihood that water could ingress into the high-voltage battery also increases. Water that ingresses into the high-voltage battery may cause an internal short circuit.

In the event of an accident, an automatic high-voltage shutdown is activated if the accident severity is high enough. This disconnects the high-voltage on-board electrical system from the battery to reduce any risk of electric shocks. However, it is still theoretically possible to access active high-voltage component parts despite the high-voltage disconnect device in the event of an accident involving damage to the high-voltage battery.

This harbors the potential risk of an electric current passing through the body or a thermal reaction occurring within the high-voltage battery.

Where possible, deactivate the high-voltage on-board electrical system using the specified high-voltage disconnect device or using the alternative high-voltage disconnect device. Do not touch any damaged high-voltage lines (line color: orange). [Page 45 ff.](#)

Pay attention to anything happening below the vehicle (noise, hissing etc.), smoke, or messages shown on the driver display, to identify any damage to or reaction of the high-voltage battery.

If uncertain, try to recover the vehicle from the water and then, if you have not done so already, secure the vehicle electrically using the specified high-voltage disconnect device or the alternative high-voltage disconnect device. If you suspect that water may have ingressed into the high-voltage battery, then avoid tilting or rocking the vehicle as much as possible during recovery and transportation of the vehicle.

Note that any water that has ingressed into the high-voltage battery can also lead to a thermal reaction at a later stage. This should be taken into consideration for transportation and storage of the vehicle.

8. Towing/transportation/storage

Safety precautions

Towing or transportation of a vehicle should always be done in accordance with the manufacturer's specifications, see the manual for the vehicle.

Towing or transportation of a vehicle should preferably always be done with a flatbed vehicle. The vehicle may otherwise be damaged. This applies in particular for vehicles with automatic transmission, with 4MATIC 4-wheel drive and for hybrid and electric vehicles. The vehicle should be transported in accordance with the applicable guidelines for towing/recovery companies.

Always observe the national regulations/standards during loading and for transportation. Country-specific and/or operator-specific provisions, e.g. tunnel regulations or guidelines for storage in enclosed spaces, must be observed for vehicles with alternative drives in particular. Observe the information in section 2 of the "Guidelines for car towing services" and in the manual for the vehicle.

Removing a vehicle from the danger zone

In principle, removal of the vehicle from the immediate danger zone at walking speed is always permitted.

Always adjust the personal protective equipment as appropriate for the situation.

Towing/transportation

General warning sign



Danger of death owing to electric voltage when towing vehicles with an electric drive. Do not tow the vehicle by the drive axle. Tow the vehicle with a flatbed vehicle.

More information on [page 161](#)

Loading of the vehicle onto a tow truck is normally recommended. The limitations in the manual for the vehicle to be towed must be observed when towing with the vehicle in contact with the ground. In the event of electrical system faults, the transmission may be jammed in the “P” position. The electrical system must be supplied with power for a short time in order to switch to the “N” gearbox setting.

Observe the information in the “Guidelines for car towing services”.

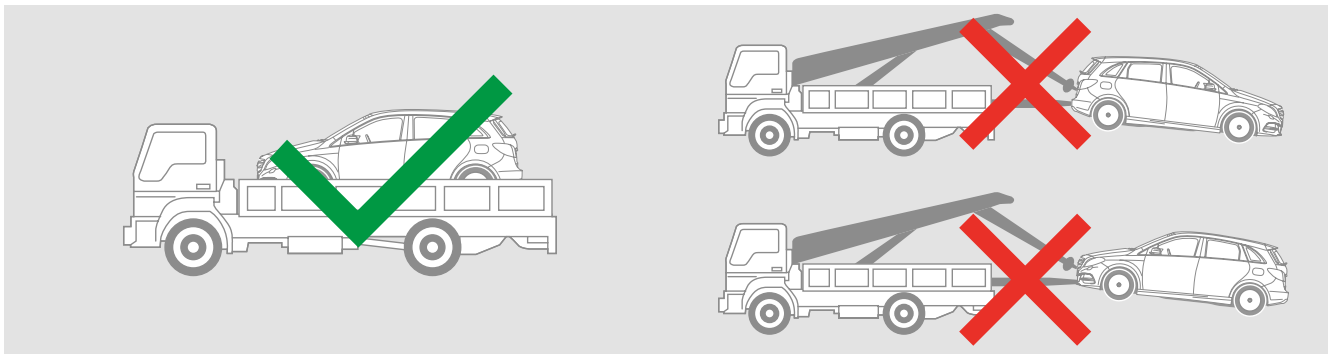

Recommendation for loading of a vehicle with a high-voltage electrical system

The subsequent emergency services (e.g. police, tow truck) may only be given access to the vehicle once the high-voltage battery has been demonstrably free from fire, smoke and heat for up to 1 hour.

The high-voltage battery must be fully cooled before the subsequent emergency services are given access to the vehicle or it leaves the scene of the incident. Always inform the subsequent emergency services that the battery may reignite.

- The high-voltage electrical system should be deactivated before loading, see the [“Disabling direct dangers/safety regulations”](#) section.
- When handing over the vehicle, e.g. to the authorities, towing/recovery contractor, workshop, or disposal company, they must be informed of the vehicle’s drive type and the fire fighting measures taken (e.g. deactivation of the high-voltage electrical system). In particular, they must be informed of a possible risk owing to damaged high-voltage components or high-voltage components which have come into contact with water (e.g. electric shock or fire risk, even delayed, from the high-voltage battery).
- The national provisions/standards (in Germany: DGUV Information 214-010 and DGUV Information 205-022, DGUV Information 200-005 and DGUV Information 214-081, as well as the provisions of the Accord européen relatif au transport international des marchandises Dangereuses par Route (ADR) – Agreement concerning the International Carriage of Dangerous Goods by Road) must be observed for loading and transportation.
- The towing/recovery contractor must ensure road safety during transportation, taking the measures which have already been taken and the extent of the damage to the vehicle into consideration. Attention must be paid to possible risks owing to damaged high-voltage components (e.g. electric shock or fire risk owing to the high-voltage battery).
- When lifting with a crane/jack, working with a winch, or loading, care must be taken to ensure that no high-voltage components are or become damaged.

Storage

Various measures should be taken in order to safely park a vehicle which has been involved in an accident. If the vehicle is brought to a workshop, the responsible experts must be informed about the measures which have already been taken (e.g. high-voltage disconnect has been actuated).

Observe the information in the “Guidelines for car towing services”.

Follow-up work on high-voltage batteries

- Damaged high-voltage batteries should be left in the vehicle and be safely transported to a specialist workshop.
- The temperature measurement on the surface of the high-voltage battery must be $< 60\text{ }^{\circ}\text{C}$. The temperature measurement should be taken with an infrared thermal imager.
- The vehicle should be transported safely to a specialist workshop via a direct route and parked in a quarantine area/secure outdoor area, away from construction work.
- Individual high-voltage battery parts should be put into special transport container for “high-voltage batteries which are not safe for transportation” and transported to a specialist workshop.



Transport container

Recommendation for storage of a vehicle with a high-voltage electrical system

- For reasons of fire safety, vehicles with high-voltage electrical systems which have been involved in an accident, like conventional vehicles, should be parked in a cordoned off area of an outdoor parking area with sufficient distance to other vehicles, buildings, flammable objects and flammable surfaces.
- Parking a vehicle with a damaged high-voltage electrical system in an enclosed hall is not recommended under any circumstances. Vehicle-specific information can be found in the vehicle-specific rescue sheet (see the [“Rescue sheets”](#) section).
- Alternatively, vehicles with high-voltage electrical systems which have been involved in an accident can be parked in fire protection systems intended for this purpose.
- Parked vehicles with high-voltage electrical systems which have been involved in an accident and have high-voltage components directly exposed to the weather should be covered with a weatherproof tarpaulin.
- The vehicle must be labelled accordingly. This must be observed in the event of vehicle delivery outside business hours in particular.

9. Important additional information

Airbags/restraint systems

This section provides additional information which may be helpful during the rescue. Mercedes-Benz and smart vehicles have multiple restraint systems which are activated using pyrotechnics. In addition to stored gas inflators, shock absorbers also constitute a potential danger because the gas which they contain expands in the event of a fire and the shock absorber piston may extend suddenly.

Warning



Risk of injury owing to an airbag deploying during the rescue operations. Disconnect all batteries. Cover vehicle occupants with foil. Use personal protective equipment. Do not place objects in the deployment area of an airbag. Helpers may not remain in the deployment area of an airbag unnecessarily.

More information on [page 163](#)

Warning



Risk of injury owing to severing of compressed gas generators when cutting vehicle parts, establish and mark the installation position of the compressed gas generators. Do not sever compressed gas generators.

More information on [page 162](#)

Important additional information

Overview of airbags/restraint systems

All vehicles from Mercedes-Benz and smart are equipped with passenger protection systems. Depending on the model, year of manufacture and configuration, these include: Airbags, seat belts with seat belt pretensioner and belt force limiter, active headrests, roll-over protection.

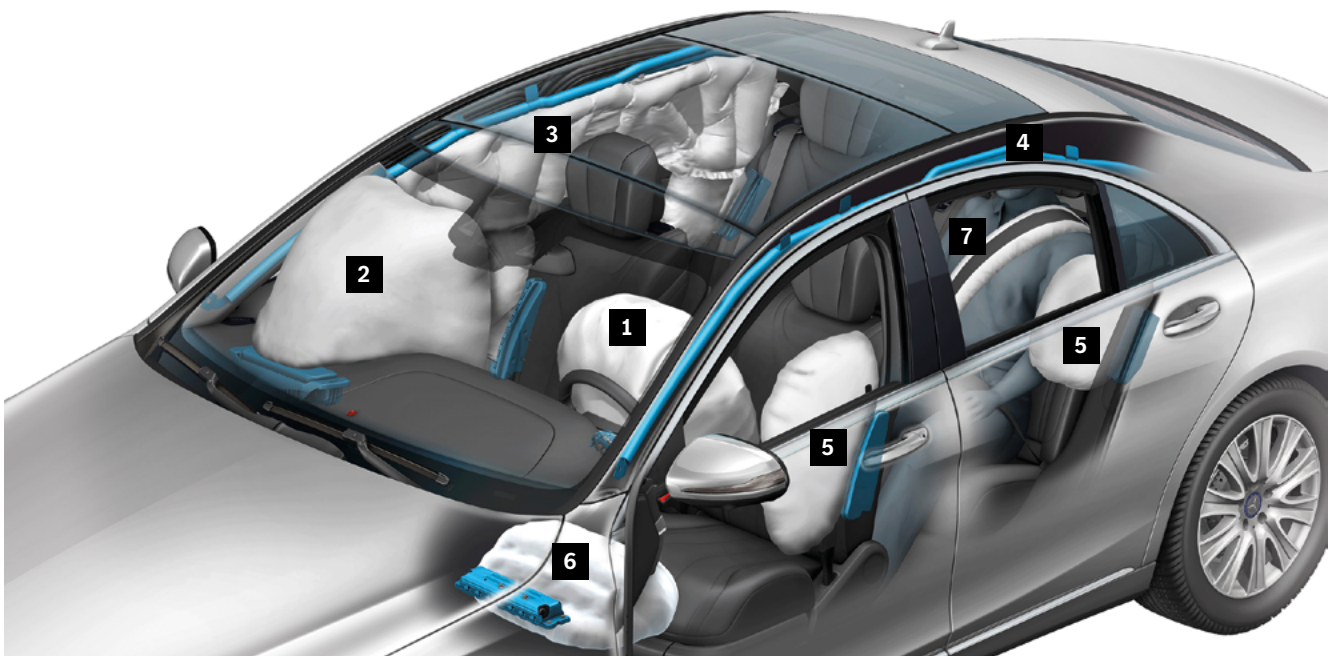

- | | |
|-------------------------------------|--|
| 1 Driver airbag | 5 Side airbag |
| 2 Passenger airbag | 6 Knee airbag |
| 3 Window airbag | 7 Seat belt airbag (seat belt on the right-hand and left-hand rear seat) |
| 4 Window airbag stored gas inflator | |

Important additional information

Installation locations of the airbags

The installation locations of the components which are relevant for the operation, e.g. airbags and restraint systems, can be found in the vehicle-specific rescue sheet (see the [“The digital Mercedes-Benz rescue assistant”](#) section).

The installation location of an airbag in the vehicle can be recognized by one of the following markings in the immediate vicinity, depending on the vehicle:

- SRS AIRBAG
- SRS
- AIRBAG
- BELTBAG

The following airbags may be present, depending on the model and vehicle configuration:

- Driver airbag (1) in the steering wheel
- Passenger airbag (2) above or instead of the glove compartment
- Side airbag (5), front
 - In the outer face of the seat back
 - In the door panel
- Side airbag (5), rear
 - In the door panel
 - In the side panel (e.g. 2-door vehicles)
 - On the wheel arch next to the seat back
 - In the seat cushions of the outer rear seats
- Window airbags (3) in the roof frame between the A and B or C pillar
- Head airbags in convertibles/roadsters deploy upwards from the door panel on the front doors
- Knee airbag (6) on the underside of the dashboard at knee-height for the driver and front passenger
- Seat cushion airbag in the centre under the seat cushion of the outer rear seats in some classes
- Seat belt airbag (7) (inflatable seat belt) on the outer rear seats in some classes
- Centre airbag between the driver and front passenger
- Rear airbag on the rear of the driver and passenger seat backs

Important additional information

Window airbags (3)

The stored gas inflators (4) for the window airbags (3) are filled not with solid fuel, but rather predominantly with compressed gas. When a window airbag (3) deploys, the stored gas inflator (4) closure is opened by the ignition pill. The panels on the A, B, C and D pillars and the inner lining of the roof should be removed before cutting the corresponding bodywork parts in order to be able to establish the precise installation location of the stored gas inflators (4).

The installation position can be found in the vehicle-specific rescue sheet:

rk.mb-qr.com/de/#rescue-card-selector

Important additional information

Seat belt airbag and centre airbag

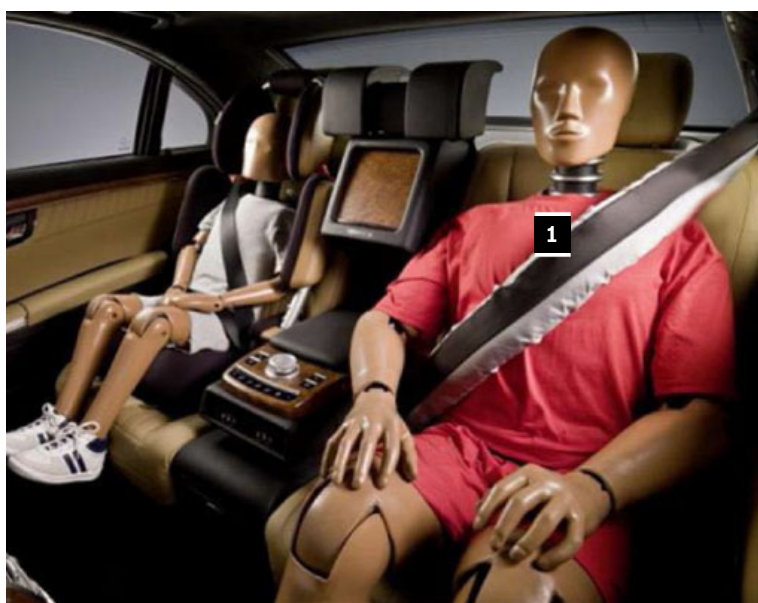

- 1 Seat belt airbag
- 2 Centre airbag

Important additional information

Rear airbag

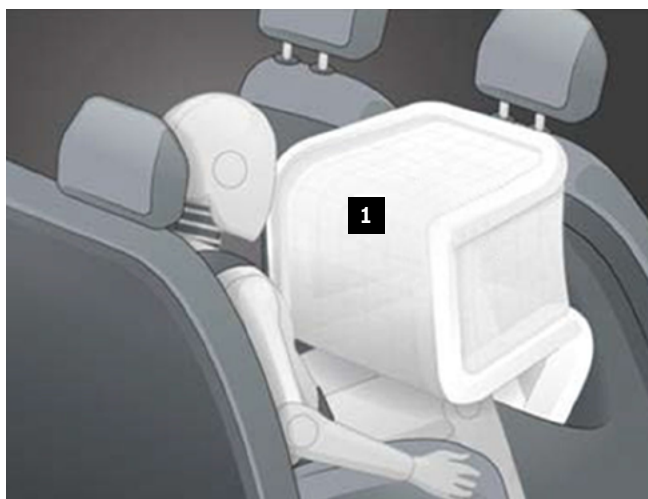

1 Rear airbag

Seat cushion airbag

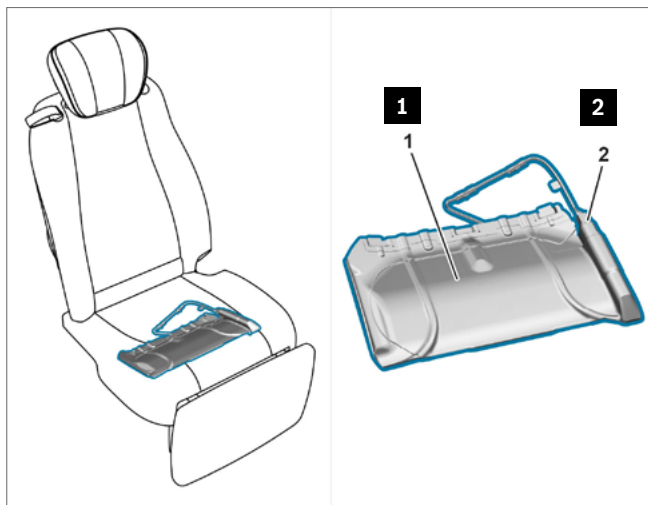

- 1 Seat cushion airbag unit
- 2 Seat cushion airbag ignition pill

Since the seat cushion airbag remains fully in the seat cushion even after deployment, it is not possible to see from the outside whether it has deployed or not.

Roll-over protection

Warning



Risk of injury owing to roll-over protection deploying during rescue operations. Disconnect all batteries. Protect the vehicle occupants with appropriate measures. Use personal protective equipment. Do not place any objects in the deployment area for the roll-over protection. Helpers may not remain in the deployment area for the roll-over protection unnecessarily.

More information on [page 164](#)

The installation positions of the components which are relevant for the operation, e.g. roll bar and battery, can be found in the vehicle-specific rescue sheet (see the “[Rescue sheets](#)” section). In some cases, injured persons must be rescued from or treated in the movement area of a roll bar which has not deployed, e.g. in the event of people who are trapped.

Overview of models

- CLK convertible, Type 208
- CLK convertible, Type 209
- C-Class convertible, Type 205
- E-Class convertible, Type 124
- E-Class convertible, Type 207
- E-Class convertible, Type 238
- S-Class convertible, Type 217
- SL roadster, Type 129
- SL roadster, Type 230
- SL roadster, Type 231

Important additional information

Example: CLK convertible roll-over protection (Type 209)

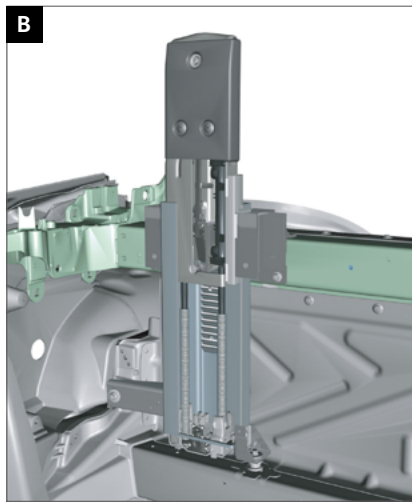
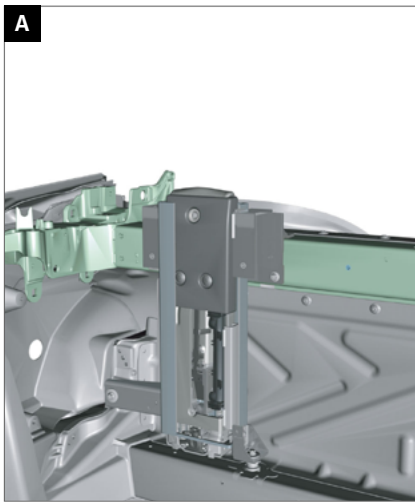

- A** Roll-over protection retracted
- B** Roll-over protection extended

Example: SL roadster roll-over protection (Type 230)



Active bonnet

Pictograms



Pedestrian protection

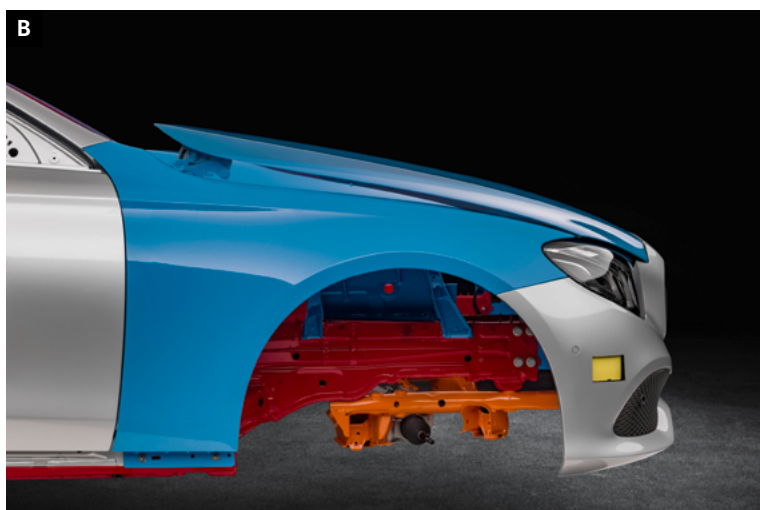
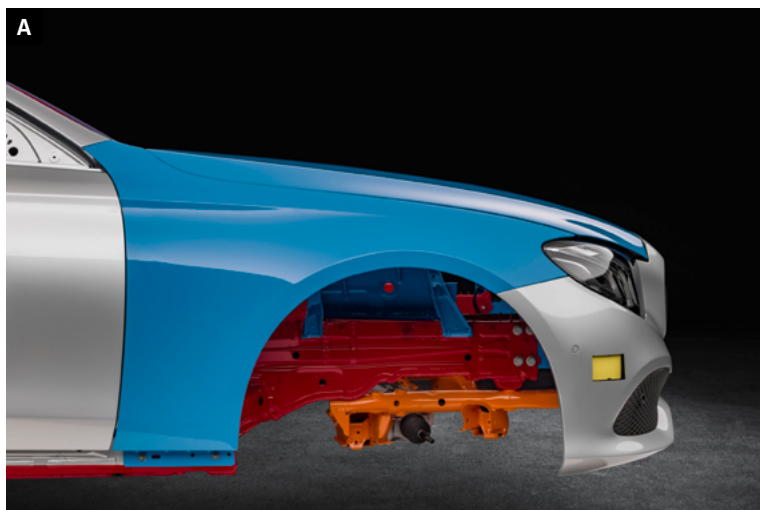

A Active bonnet, not triggered

B Active bonnet, triggered

Important additional information

Pedestrian protection system components in the example of a B-Class (Type 246)

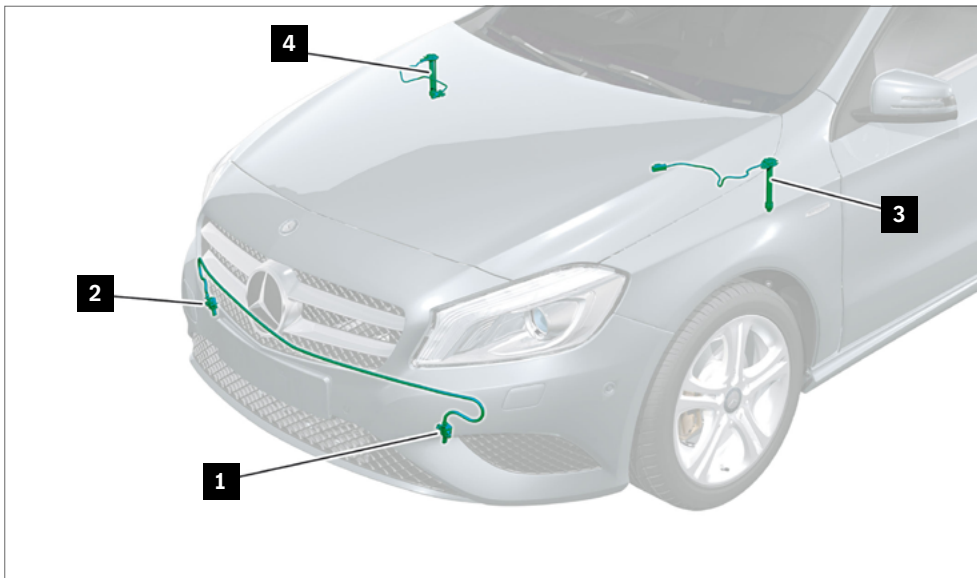

- 1 Bumper impact sensor, front left
- 2 Bumper impact sensor, front right

- 3 Active bonnet stored gas inflator, left
- 4 Active bonnet stored gas inflator, right

Active bonnet

The aim of the active bonnet is to generate more crumple space between the bonnet and hard components in the engine compartment in the event of a collision with a pedestrian. Deployment therefore needs to occur very quickly. Older vehicles sometimes have solutions with a pre-loaded spring, in newer vehicles the lifter is actuated using stored gas inflators.

The lifters can be triggered by an electrical signal or through significant heat exposure in the event of a vehicle fire.

High-voltage components

Warning sticker

High-voltage components in the vehicle always have a warning sticker.



High-voltage cables

High-voltage cables are orange.

Example: Mercedes-Benz vehicle, C-Class HYBRID, Type 206

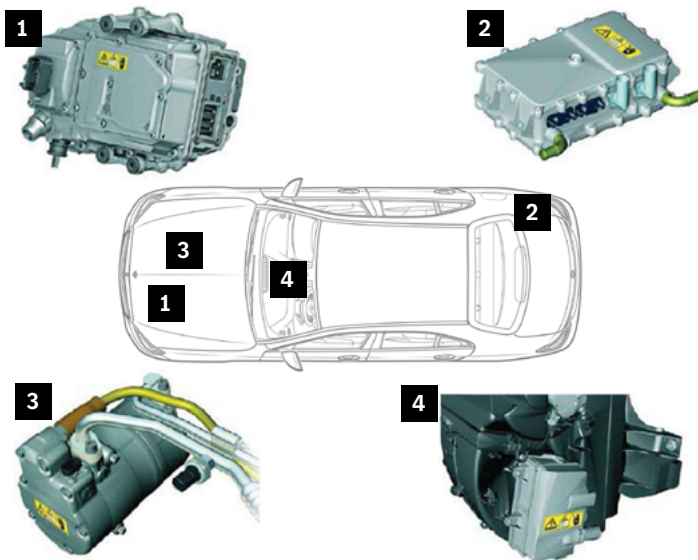

- 1 Power electronics
- 2 Charger
- 3 Electric coolant compressor
- 4 High-voltage PTC heater

The installation position of the high-voltage components can be found in the vehicle-specific rescue sheet (see the [“Rescue sheets”](#) section).

Important additional information

Power electronics (1)

The main job of the power electronics (1) is to convert the DC voltage from the high-voltage battery into three-phase AC voltage at the same frequency so that the electric drive motor can be operated at its optimal operating point when required. Some hybrid vehicles do not have the conventional 12-volt generator. The function of the generator is assumed by a DC/DC transformer which converts the DC voltage from the high-voltage battery into the DC voltage required for the 12-volt electrical system.

Charger (2)

A charger (2) is required to charge the high-voltage battery from the electric power supply. It converts the AC voltage to the DC voltage required for a high-voltage battery at the specified charging capacity. The charger (2) also creates the safety-related electrical isolation between the power supply in a charging station and the high-voltage battery.

Electric coolant compressor (3)

In order to provide sufficient cooling power for the air-conditioning component even in a stationary vehicle with the engine switched off, it is necessary to decouple the drive motor. This ensures independent cooling of the high-voltage battery and air conditioning in the interior of the vehicle. This is done using a coolant compressor (3) powered by electricity. In vehicles which run purely on electricity, cooling is always achieved using an electric coolant compressor (3).

High-voltage PTC heater (4)

Depending on the vehicle type, the high-voltage PTC heater (4) is located on the air conditioning cabinet or in the rear section of the right-hand wheel arch. The high-voltage PTC heater (4) has the job of warming the coolant. The heating circuit recirculation pump carries the coolant to the heat exchanger and thus allows for heating of the interior of the vehicle.

Other innovations

Active headrest (NECK-PRO headrest)

NECK-PRO headrests are installed on the front seats in some older Mercedes-Benz vehicles. In the event of a rear-end collision of a certain severity, the NECK-PRO headrests on the driver and passenger seat are moved forward in the direction of travel and upward. This is intended to improve support for the head.

Mercedes-Benz Guard armoured car

Mercedes-Benz offers armoured cars in various models and configurations ex works. These vehicles have materials with particular reinforcement in the following areas, for example:

- Bodyshell
- Doors and tailgates
- Underbody
- Vehicle windows

10. Pictogram overview

Pictogram overview

Drive type pictograms



Vehicle with class 1 fuel
(diesel)



Vehicle with class 2 fuel
(petrol, ethanol, etc.)



Vehicle fuelled by natural gas



Vehicle with fuel cell system



Hybrid electric vehicle with class 1 fuel
(diesel)



Hybrid electric vehicle with class 2 fuel
(petrol, ethanol, etc.)



Electric vehicle

Drive type pictograms



Opening the bonnet



Open the boot lid

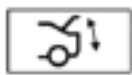

Boot lid convenience closing

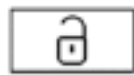

Unlock the vehicle



Lock the vehicle

Pictogram overview

Drive type pictograms



Switch off the 12/48-V electrical system



Switch off the high-voltage electrical system

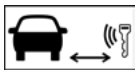

Minimum distance from digital vehicle key to vehicle



Alternative high voltage device that disconnects high voltage

Vehicle operation pictograms



Steering column adjustment



Seat height adjustment



Forward/backward seat adjustment

Vehicle operation pictograms





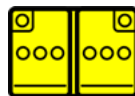











Pedestrian protection



12 V/48 V battery

Pictogram overview

Drive type pictograms

	Automatic gas overpressure safety valve with gas type indication (CNG)		Compressed natural gas (CNG)
	H ₂ automatic overpressure valve		Gas tank with content labelling (H ₂)
	Use water to extinguish the fire		Extinguish with ABC powder
	Do not extinguish with water		General warning sign
	Warning: electric voltage		Warning: low temperature/cold
	Attention: Hydrogen burns with an almost colourless flame		Carbon fibre-reinforced plastic
	Use thermal infrared camera		Special battery access

Pictogram overview

Hazard symbols in accordance with the safety data sheet



Corrosive substances



Hazardous to the human health



Flammable



Explosive



Environmentally hazardous



Compressed gases



Toxic (acute toxicity)

11. Annex

Explanations of the indications

General warning sign



Danger of death owing to the vehicle slipping or tipping while lifting.
Only lift the vehicle at the attachment points stipulated by the vehicle manufacturer.

Risk of accident and injury

The vehicle may only be lifted by the vehicle hoist or jack attachment points specified by the vehicle manufacturer. Care must be taken to ensure that the vehicle is optimally positioned and is secured against tipping in accordance with the generally applicable safety requirements and rules. In the event of failure to observe the safety regulations, the vehicle may slip out of the lifting device and critically or fatally injure people in the process.

The safety regulations for the respective country always apply. It is the user's responsibility to comply with these.

General warning sign



Risk of fire/explosion owing to short circuit and leaking oxyhydrogen gas. Risk of burns/injury owing to burns to eyes, skin and mucous membranes owing to battery electrolyte/smoke, short circuit and arc exposure. Risk of poisoning owing to swallowing battery electrolyte or absorption of lead through the skin or orifices. Danger of death owing to electric voltages $U \geq 30$ V AC and $U \geq 60$ V DC. Fire, sparks, open flames and smoking are prohibited. Wear acid-resistant gloves, clothing and goggles. Only pour battery acid into suitable and appropriately labelled containers.

Annex

Possible dangers

Electrocution can result in involuntary muscle contractions, cardiac arrhythmia, ventricular fibrillation, cardiac arrest, respiratory arrest, burns, or other cell damage. The severity of the injury depends on the amperage, type of current, frequency of the current, exposure time and the path through the human body.

Risk of fire/explosion

Charging lead-acid batteries creates a highly explosive oxyhydrogen gas mixture which can be ignited by fire, sparks, open flame and smoking. In the event of a positive to negative battery short circuit, the battery connections and the conductive objects which caused the short circuit, such as a tool or piece of jewellery (watch strap or ring), as well as the battery become hot in seconds. There is a risk of fire/explosion. There is a risk of fire/explosion in the event of an internal short circuit in the battery cells. In the event of improperly closed venting/electrolyte discharge openings, there is a risk of fire/explosion owing to excess pressure in the battery housing. Do not subject batteries to mechanical pressure. There is a risk of fire/explosion.

Risk of injury/burns

Contact with the battery electrolyte/smoke causes significant irritation of the skin, eyes and mucous membranes. Deep damage to the tissue occurs. In the event of a positive to negative battery short circuit, the battery connections and the conductive objects which caused the short circuit, such as a tool or piece of jewellery (watch strap or ring), become hot in seconds and smouldering/molten metal splashes are released. Do not subject batteries to mechanical pressure. There is a risk of short circuits and leakage of battery electrolyte/smoke. Electric arcs can occur as a result of disconnection of battery terminals or plug-in connectors under load or owing

to a short circuit. Arc exposure may result in 1st to 4th degree burns, flash blindness owing to strong UV light (similar to welding), blast injury and injuries owing to moving parts.

Risk of poisoning

Poisoning symptoms such as headaches, dizziness, stomach pain, respiratory paralysis, loss of consciousness, vomiting, chemical burns and convulsions should be expected if battery electrolyte is swallowed. Uptake of lead from acid batteries into the body through contact with components which contain lead (battery terminals, lead plates from damaged batteries) damages the blood, the nerves and the kidneys. Lead compounds are also considered to be toxic to reproduction. The risks of poisoning set out above also apply for lead-antimony batteries.

Danger of death

Danger of death owing to $U \geq 30$ V AC voltage or $U \geq 60$ V DC voltage.

Secondary accidents

Secondary accidents occur as a result of shock reactions caused by contact with electric voltage from high-voltage batteries and arc exposure. These include falling from a work area at a height or hitting your head on a bonnet, among other things.

Protective measures/rules of conduct

- If there is an immediate danger from a lithium-ion battery owing to smoke, fire, heat generation, leaking electrolyte (can be seen/smelled), immediately make an emergency call to the appropriate site and country-specific emergency number. Do not touch the lithium-ion batteries and clear the danger zone.
- Qualification is required for handling lithium-ion batteries. You can acquire the necessary qualification through Mercedes-Benz Global Training, among others. You can find out from your MPC whether additional country-specific regulations and the legislation require further specialist qualification. The appropriate qualifications/protective measures/briefings must be implemented in accordance with the relevant documentation on the topic in WIS, TIPS, EVA and country-specific sources, where applicable, before beginning work and during work.
- Keep batteries and battery electrolyte away from unauthorized persons.
- Fire, sparks, open flames and smoking are prohibited.
- Do not subject batteries to mechanical pressure.
- Do not charge batteries with a damaged housing and do not reinstall them.
- Only charge 12 V batteries in well ventilated spaces with the correct voltage and current with approved chargers, observing the instructions from the battery and charger manufacturers.
- Only switch on the charger for 12 V batteries after connecting it to the terminals; switch it off before disconnecting.
- Care must be taken to ensure that the venting/electrolyte discharge openings are not improperly closed and the corresponding attachments for discharging the gases/electrolytes are correctly connected.
- Check that venting line is free from kinks and has perfect continuity.
- Always disconnect the negative terminal first, always connect the positive terminal first. Otherwise there is a potential risk of a short circuit between the positive terminal on the battery and the bodywork through the tool.
- Only pour leaking battery electrolyte into suitable and appropriately labelled containers.
- Batteries with liquid battery electrolyte are only to be stored, transported and installed in a horizontal position, otherwise the battery electrolyte may leak out of the venting openings.
- In vehicles with a 48-V electrical system, wait at least 10 s before disconnecting the 12-V positive cable in order to ensure that the recharge function is deactivated.
- Do not charge 48 V batteries directly, but rather charge them via the 12-V electrical system using the available/approved 12-V charger.
- Do not place any tools or other conductive objects on the battery; risk of short circuit!
- Wear acid-resistant clothing and safety goggles with a side guard when handling open and damaged batteries.
- Observe the manual provided for the respective batteries.

Explanations of the indications

General warning sign



Risk of explosion owing to leakage of flammable gases or overheating of the gas tank. Risk of injury owing to burns on the skin and eyes. Risk of frostbite to body parts owing to leaking gas and owing to touching components near valves when emptying gas tanks. Risk of poisoning or suffocation owing to breathing in gases.

Eliminate sources of ignition. Wear protective clothing, protective gloves, safety goggles.

Ensure sufficient ventilation. All gas tanks must be removed for work on the vehicle in ambient temperatures of more than 60 °C.

Possible dangers

Risk of explosion

There is a risk of explosion in the event of escaping gas (e.g. owing to a leak) or if the gas tank is overheated.

Risk of injury

There is a risk of burns to the skin and eyes in the event of unintentional ignition of escaping gas.

Risk of frostbite

When emptying full gas tanks, the expanding gas cools so rapidly that frostbite can occur when touching components near the valve.

Risk of poisoning and suffocation

If gas is breathed in, then there is a risk of poisoning and suffocation in the event of high concentrations of gas in the ambient air. In this context, attention must be paid to possible accumulations of gas in an enclosed space.

Protective measures/rules of conduct

Smoking, fire, open flames and mobile phones are prohibited:

- in the vicinity of a filling station,
- in the vicinity of the engine compartment,
- in the vicinity of the gas tank,
- in the vehicle storage hall or the workshop

Workshops must have sufficient vents in the ceiling area of the hall to ensure that escaping gas can rise harmlessly into the open air. Before beginning work, care must be taken to ensure that all sources of ignition are removed. Sufficient ventilation must be ensured in the immediate vicinity of the vehicle.

Sufficient ventilation means an air exchange rate of 3 times per hour at a distance of 3 m from the gas shut-off valve.

The gas shut-off valves on the gas tanks must be closed before beginning repair work. The gas lines must be emptied after closing the gas shut-off valves by allowing the engine to run.

The gas lines are sufficiently empty if the engine switches to petrol mode after several minutes of idling or stops automatically.

Type 956, 963 with two pressure relief valves on the gas tank: Care must be taken to ensure that the line which leads to the pressure relief valve remains at the gas pressure of the corresponding gas tank, even with the gas shut-off valve closed. This state of construction is indicated in the document AH00.10-N-1000-06A.

Vehicles with gas systems in which the gas shut-off valves remain closed and the gas lines have been emptied can be operated and treated like vehicles which run on petrol, provided that

- the gas shut-off valves remain closed,
- the gas lines are empty, and
- no temperatures of more than 60 °C can be expected for the gas tank.

Work with ignition risks is only permitted on vehicles with natural gas systems if specific protective measures are taken, e.g. closing the gas shut-off valves, measures against gas leaks and measures against increases in pressure owing to a temperature increase in the gas tank or in the gas lines.

Where applicable, the gas lines must be emptied and the gas tanks must be removed.

Explanations of the indications

Maintenance and repair work may only be carried out by specially trained personnel. Vehicles with natural gas systems on the workshop premises must have indication of the natural gas system in a clearly visible location. Natural gas is lighter than air and can accumulate in the air under certain circumstances. Vehicles with natural gas systems in which the gas shut-off valves have not been closed and the gas lines have not been emptied may therefore only be parked in locations in which there is an air exchange rate of at least 3 times per hour.

If temperatures of more than 60 °C can be expected for gas tanks filled with natural gas in dryers for coating materials (e.g. during painting), then they must be removed before drying. A leak test must be carried out after work on the components or the gas lines in the natural gas system. The requirements for the leak test differ from country to country. Refer to the national legislation for the precise requirements. Detection of leaks in the natural gas system may only be done such that any possible escaping gas cannot be ignited.

Leak indicators which can also carry out gas measurements significantly below the explosive limit are particularly suitable as gas measuring and warning devices here. A leak detection spray is used to accurately locate leak points.

Natural gas can lead to frostbite. Leather protective gloves should be used where applicable.

Annex

Discharge area

Wherever possible, emptying of the gas system through discharging should be avoided because natural gas is a greenhouse gas. Furthermore, discharging may result in nuisances in the surrounding area.

If discharging is unavoidable, then the vehicle or system manufacturer's specifications must always be observed.

In principle, release of pressure through discharging of gas systems may only be done outdoors. A marked out area of approx. 10 × 10 m is required for release of pressure in the gas system. There may not be any other vehicles in this area and no other work may be carried out in this area during the pressure release process.

The discharge area should preferably have a lightning protection system (lightning conductor). Alternatively, releasing the pressure in the system if there is a risk of thunderstorms may be prohibited by the operating instructions. It should be possible to ground the vehicle (e.g. using a steel rod hammered into the ground) in the discharge area.

Characteristic of CNG:

If the discharge area is roofed in full or in part, then care must be taken to ensure that the escaping gas can flow upward freely.

Storage area for gas tanks which have been removed and not made inert

Gas tanks which have been removed and not made inert should not be stored in the general maintenance and repair area. The storage area can also be outdoors. The storage area must be labelled and can be secured against access to the cylinders using small mesh, for example. Unobstructed exchange with the ambient air must always be possible.

Explanations of the indications

General warning sign



Risk of explosion owing to leakage of hydrogen or overheating of the fuel tank during operations on the hydrogen system. Risk of frostbite to body parts owing to leaking gas and owing to touching components near components which carry gas when emptying fuel tanks. Risk of suffocation owing to breathing in air diluted with hydrogen. Risk of burns owing to stumbling into an invisible pale blue hydrogen flame.

Possible dangers

Risk of explosion

There is a risk of explosion in the event of hydrogen escaping from the system (e.g. owing to a leak) or if the fuel tank is overheated. Smoking, fire, open flames and mobile phones are prohibited.

Always observe the safety information, there is an increased risk of explosion in the following danger zones:

- In the vicinity of a filling station.
- When working of the fuel cell system.
- When working on the fuel system.
- In the vehicle storage hall or the workshop.

Observe the following information concerning the risk of explosion:

- Hydrogen is flammable at a concentration of approx. 4-77% by volume in the air.
- There is a risk of explosion from a hydrogen concentration of approx. 18% in the air (oxyhydrogen gas).
- Ignition only requires a low amount of energy (e.g. electrostatic charge).
- Hydrogen is 14 times lighter than air, rises and can accumulate to form an explosive mixture under roofing, for example.
- High storage and operating pressure (high pressure up to 700 bar).

Risk of frostbite

When emptying fuel tanks which are filled with hydrogen, the expanding hydrogen cools very rapidly. Frostbite can occur when touching the components which carry the hydrogen. Frostbite can also occur when touching the components which carry the hydrogen when refuelling with pre-cooled hydrogen. Use suitable protective gloves!

Risk of suffocation

If hydrogen is breathed in, then there is a risk of suffocation owing to a lack of oxygen in the event of high concentrations of gas in the ambient air. In this context, attention must be paid to possible accumulations of hydrogen in an enclosed space.

Risk of burns

The greatest danger posed by burning hydrogen is the invisible pale blue flame. It is possible to accidentally stumble into this pale blue flame since it looks to all intents and purposes like shimmering hot air. The flame temperature can reach up to 2000 °C.

Rules of conduct/protective measures

Operations on components in the hydrogen system may only be carried out by persons who can demonstrate that they have taken part in special qualification measures and are authorized.

Wear suitable personal protective equipment.

The "Requirements for entry to the workshop" which are set out in the workshop documentation must be met.

Before beginning work, ensure that all sources of ignition are removed.

Ensure that sufficient ventilation with an air exchange rate of at least three times/hour is present at a distance of 3 m from the shut-off valve for the fuel cell vehicle.

If there are indications of leaks and problems in the fuel cell system, secure the fuel cell vehicle and park it outdoors. A sufficient safe distance from adjacent buildings and surrounding vehicles must always be observed here (radius of 10 m).

A clearly visible sign or similar must be attached to the fuel cell vehicle in order to prevent it from being accidentally brought in.

Emptying the fuel system and releasing the pressure in the fuel cell system may only be done in an area marked off specifically for this purpose and in the open air.

Annex

No hydrogen may accumulate under the following areas:

- Roofing
- Edges
- Ventilation dead zones

- 1 Cordon off the discharge area at a radius of at least 5 m.
- 2 Clear warnings of an explosive atmosphere must be placed at the access points.
- 3 The distance to buildings must be sufficient that the rising hydrogen cannot accumulate or be blown in through surrounding open windows.
- 4 Check the direction of the wind and surrounding buildings in this respect in advance.
- 5 There may not be any vehicles in the discharge area and no other work may be carried out in this area during these operations.
- 6 The vehicle and the discharge flue must be grounded.

When using a mobile discharge flue, this must always be grounded first before a hydrogen atmosphere can occur. Only then should the fuel cell vehicle be parked in the emptying space. The same applies for fuel cell vehicles with a leak. Always adhere to the work sequence.

The personnel must discharge themselves electrostatically in a suitable location before commencing operations. Do not use any electric equipment (cordless screwdriver, electric wheel lift, etc.) during the operations.

The prescribed design of the discharge flue can be found in the appropriate repair manual.

Work with ignition risks is only permitted on a fuel cell vehicle if specific protective measures are taken, therefore the following must be observed:

- 1 The fuel cell vehicle must be protected against hydrogen leaks and against an increase in pressure in the fuel tanks or in the hydrogen lines owing to a temperature increase.
- 2 Component temperatures of ≥ 60 °C can be expected for fuel tanks filled with hydrogen in dryers for coating materials (e.g. during painting). If the expected exposure time is ≥ 60 min, then the fuel tanks should be removed first.
- 3 After opening the fuel cell system, carry out a thorough leak test on all defined hydrogen line connections in accordance with the specifications.

Carry out the following work where applicable:

- Empty the fuel system, make the fuel tank inert and remove it.
- Release the pressure in the fuel cell system and flush the fuel cell stack.

Necessary gas system inspection for the high pressure and medium pressure range.

The requirements for the leak test differ from country to country. Refer to the appropriate national legislation for the precise requirements.

Annex

Leak indicators which can also carry out gas measurements significantly below the explosive limit are particularly suitable as gas measuring and warning devices for leak detection and the subsequent leak test.

More information can be found in the appropriate repair and maintenance manuals.

Carry out the following operations before repairs to the fuel cell system:

- 1 Close the manual shut-off valves on the fuel tanks.
- 2 Release the pressure in the fuel cell system. The fuel tanks can remain pressurized because the manual valves are closed.
- 3 Attach the relevant logs to the fuel cell vehicle securely and in a clearly visible location. The respective logs are listed in the appropriate repair and maintenance manuals.

Carry out the following operations before removing the fuel cell component:

- 1 Release the pressure in the fuel cell system.
- 2 Flush the fuel cell stack.
- 3 Attach the relevant logs to the fuel cell vehicle or to the fuel cell component securely and in a clearly visible location. The respective logs are listed in the appropriate repair and maintenance manuals.

Carry out the following operations before removing one or both fuel tanks:

- 1 Empty the fuel system.
- 2 Make the fuel tanks inert.
- 3 Attach the relevant logs to the fuel cell vehicle or to the fuel tank securely and in a clearly visible location. The respective logs are listed in the appropriate repair and maintenance manuals.

Explanations of the indications

General warning sign



Danger of death when working on components and systems with $U \geq 30$ V AC voltage or $U \geq 60$ V DC voltage.

Do not touch damaged or defective live components and cables, as well as electrical connections and cables which are not insulated.

Electric voltage

Electric voltage of $U \geq 30$ V AC voltage or $U \geq 60$ V DC voltage occurs in the following systems and components in vehicles and assemblies:

- In the high-voltage electrical system and high-voltage components of HYBRID vehicles, electric vehicles and fuel cell vehicles
- In the lithium-ion batteries in HYBRID vehicles, electric vehicles and fuel cell vehicles
- In fuel cell components
- In the solenoid and piezo injectors, their control units and their supply lines in petrol and diesel engines
- In the spark plugs, ignition coils, their control units and their supply lines in the ignition system in petrol and natural gas engines
- In the ballasts, xenon lights and their supply lines in xenon headlights
- In the MAGIC SKY CONTROL, DC/AC transformers and their supply lines
- In voltage transformers from 12 or 24 V to 230 or 110 V
- In ignition spark generators and electrodes and their supply lines in auxiliary heating systems
- In systems which are supplied by generators powered by the engine or by external connections with a voltage of $U \geq 30$ V AC voltage or $U \geq 60$ V DC voltage
- In DC generators with faulty rectifier diodes
- In illuminated entry strips, DC/AC transformers and their supply lines

Possible dangers owing to electric voltage of $U \geq 30$ V AC voltage or $U \geq 60$ V DC voltage

Electrocution can result in involuntary muscle contractions, cardiac arrhythmia, ventricular fibrillation, cardiac arrest, respiratory arrest, burns, or other cell damage. The severity of the injury depends on the amperage, type of current, frequency of the current, exposure time and the path through the human body. Arc exposure may result in 1st to 4th degree burns, flash blindness owing to strong UV light (similar to welding), blast injury and injuries owing to moving parts. Secondary accidents occur as a result of shock reactions caused by contact with electric voltage or arc exposure. These include falling from a work area at a height or hitting your head on a bonnet, among other things. Any of these harmful effects can result in serious injuries and even death. Effects may occur up to 24 h after the time of the accident. It is therefore essential to seek medical attention immediately after an accident involving $U \geq 30$ V AC voltage or $U \geq 60$ V DC voltage.

Protective measures/rules of conduct

- People with electronic implants (e.g. pacemakers) may not carry out work on components and systems with $U \geq 30$ V AC voltage or $U \geq 60$ V DC voltage.
- For work on components and systems with $U \geq 30$ AC voltage or $U \geq 60$ V DC voltage, the necessary protective measures must be taken in accordance with the country-specific regulations and legislation before beginning work and the appropriate qualifications/briefings must be implemented in accordance with the relevant documentation on the topic in WIS, TIPS, EVA and country-specific sources where applicable before beginning work and during work. The protective measures required for work on components and systems with $U \geq 30$ AC voltage or $U \geq 60$ V DC voltage or the personal protective equipment (PPE) required can be found in the relevant documentation on the topic in WIS, TIPS, EVA and country-specific sources where applicable before beginning work.
- Only tested tools with appropriate approval may be used for work on components and systems with $U \geq 30$ V AC voltage or $U \geq 60$ V DC voltage.
- No damaged or faulty live components and cables and no electrical connections and cables without insulation may be installed on components and systems with $U \geq 30$ V AC voltage or $U \geq 60$ V DC voltage.

Explanations of the indications

General warning sign



Risk of explosion owing to ignition, risk of poisoning owing to inhalation and ingestion of fuel, and risk of injury owing to skin and eye contact with fuel.

Fire, sparks, open flames and smoking are prohibited. Only pour fuels into suitable and appropriately labelled containers. Wear protective clothing when handling fuel.

Possible dangers

Risk of explosion, poisoning and injury

Fuels are highly flammable and toxic if ingested. Fuel can cause skin damage. For instance, the skin is degreased through contact with petrol. Fuel vapours are explosive, invisible and spread across the ground. They are toxic if breathed in and have a narcotic effect in higher concentrations.

Protective measures/rules of conduct

- Observe country-specific safety regulations and provisions.
- Fire, sparks, open flames and smoking are prohibited.
- Ensure sufficient ventilation in the work space, particularly in relation to the country-specific regulations for benzene vapours.
- Never drain or pour fuels into working pits.
- Deposit drained fuel into suitable and sealable containers.
- Clear up leaked fuel immediately.

Carrying out work on the vehicle with an open flame (e.g. welding or similar)

- Remove the appropriate parts of the fuel system and seal open fuel lines with plugs before carrying out these works.

First aid measures

- Clean affected skin areas with soap and water.
- Change affected clothing as quickly as possible.
- If fuel gets into the eyes, immediately rinse the eyes with water; seek medical attention where necessary.

Connecting fuel lines

The following assembly instructions must be observed and the respective prescribed tools must be used when opening and closing hose or line connections which carry fuel:

Annex

Plug-in connector

- The fuel lines (1a, 1b) must be plugged to one another with unlocked safety clips (1) until the safety clips (1) fully engage when pushed in.
- Correct locking of the fuel lines (1a, 1b) must be verified by pulling them apart slightly. Plug the fuel lines (1a, 1b) into one another again if necessary.

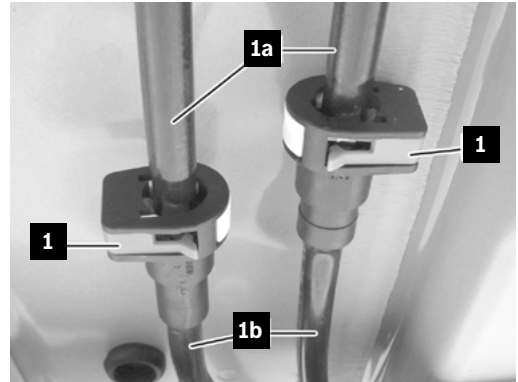

Click bracket

- The click brackets (2) must be positioned at the prescribed fuel hose (2a) position and pushed together with a click bracket pincer until they engage.
- Correct locking of the click bracket (2) must be checked through a visual inspection.

Always replace click brackets.

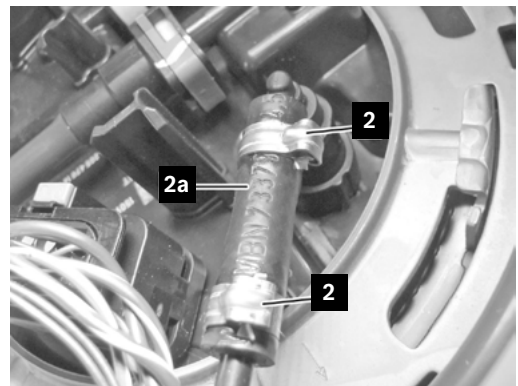

Quick connection

- The quick connection (3) must be plugged in until it engages at the connection.
- Correct locking of the quick connection (3) must be checked by pulling it apart slightly. Plug the quick connection (3) again if necessary.

The locking clip (arrow) must be flush with the quick connection (3).

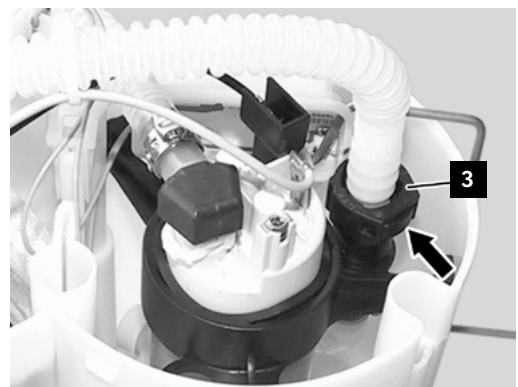

Explanations of the indications

Warning



Risk of injury to skin and eyes owing to handling of hot or smouldering surfaces.
Risk of fire in the event of contact between smouldering surfaces and flammable materials.
Wear protective gloves, protective clothing and safety goggles where necessary.
Avoid contact between flammable material and smouldering surfaces.

Possible dangers

Risk of injury

Contact with hot or smouldering surfaces without suitable protective clothing can result in serious burns to the skin and eyes.

There is a risk of fire in the event of contact between smouldering surfaces and flammable materials.

Contact between smouldering surfaces and water results in hot steam or water splashes which can cause serious burns to the skin and eyes.

Protective measures/rules of conduct

- Wear protective clothing, safety goggles, heat-resistant gloves.
- If possible, allow hot or smouldering components to cool to the ambient temperature; if not possible, transport them only using the tools intended for this purpose.
- Avoid sparking and contact with flammable material when handling smouldering surfaces.
- The personnel must be able to demonstrate knowledge pursuant to the OSHA conditions and act accordingly (OSHA stands for Occupational Safety and Health Administration).



First aid measures

In the event of burns, cool the affected part of the body under cold running water for at least 15 minutes. Cover the affected area with a sterile Metalline fire cloth. Place the side coated with Metalline on the injured skin and hold it in place loosely with a gauze bandage or a triangular bandage. The fire cloth does not stick to the wound, retains heat and protects against contamination.

In the event of serious injuries, seek medical assistance immediately.

Explanations of the indications

General warning sign



Risk of injury owing to unintentional movement of the bodywork.
Secure and stabilize the vehicle before working on the bodywork.

Significant forces act on the bodywork when using hydraulic rescue equipment.

Possible dangers

Risk of injury

Unintentional bodywork movements caused by rescue operations can cause further serious or life-threatening injuries to the vehicle occupants.

Protective measures/rules of conduct

The vehicle must be secured and stabilized with suitable aids before rescue operations commence.

These aids include the following, for example:

- Chocks
- Underfloor sliding blocks
- Scaffolding
- Lashing straps
- Scaling ladders

Various manufacturers offer commercial car support sets which allow for stabilization even in complex situations.

Explanations of the indications

General warning sign



Risk of injury owing to sharp-edged cut surfaces when separating or cutting vehicle parts.
Cover sharp-edged cut surfaces with sheets or pillar protection.
Use personal protective equipment.

Possible dangers

Risk of injury

Separating or cutting vehicle parts with rescue equipment may create sharp-edged cut surface. These can cause serious or life-threatening injuries to the vehicle occupants or the rescue personnel.

Protective measures/rules of conduct

- Cover sharp-edged cut surfaces with suitable sheets or pillar protection.
- Use personal protective equipment.

Explanations of the indications

Warning



Risk of injury owing to glass fragments and shards when removing vehicle windows and panoramic roofs. Cover the vehicle occupants. Use personal protective equipment. Remove vehicle windows and the panoramic roof before working on adjacent components.

Significant forces act on the bodywork when using hydraulic rescue equipment.

Possible dangers

Risk of injury

Glass fragments may be created as a result of work on vehicle windows and panoramic roofs or work on adjacent components.

Windows may crack, and extremely small, sharp particles of glass may fly off and cause injuries to the vehicle occupants and rescue personnel.

Protective measures/rules of conduct

- Vehicle occupants should preferably be covered with a transparent sheet before glass work is started. Covering with opaque covers or tarpaulins should be avoided wherever possible for psychological reasons.
- Use personal protective equipment.
- Remove vehicle windows and the panoramic roof before working on adjacent components.

Explanations of the indications

Warning



Risk of injury owing to unintentional movement of the seat or the steering wheel. Disconnect all batteries. If there is a risk of becoming trapped, immediately stop seat adjustment and steering column adjustment.

Possible dangers

Risk of injury

In vehicles with entry and egress assistance systems, the steering wheel is moved upward to the stop and the driver's seat is moved back slightly after switching off the ignition. Unintentional movement of the seat or the steering wheel during rescue operations results in the risk of vehicle occupants becoming trapped. This can cause minor to severe injuries or exacerbate injuries already sustained.

Protective measures/rules of conduct

Where possible, disconnect all batteries before commencing rescue operations.

If there is a risk of becoming trapped, seat adjustment and steering column adjustment must be stopped immediately.

Exemplary illustrations



- 1 Steering column adjustment control lever
- 2 Steering column adjustment switch in the button block on the driver's door
- 3 Seat adjustment switch in the button block on the driver's door
- 4 Memory function position button

The adjustment process can be stopped as follows:

- Actuate the steering column adjustment control lever (1) on the steering wheel.
- Actuating the steering column adjustment switch in the button block on the driver's door (2).
- Actuate the memory function position button (4).

Explanations of the indications

General warning sign



Risk of electric shock in a vehicle fire.

Observe safe distances during fire fighting. Carry out fire fighting measures with personal protective equipment and self-contained breathing apparatus.

Avoid touching damaged areas. Cover damaged parts with a suitable cover.

In principle, there is no danger to people owing to electric shock thanks to the following protective mechanisms:

- The high-voltage electrical system is designed with touch protection.
- The high-voltage electrical system has full protective insulation and has no connection to the bodywork (electrical isolation).
- The high-voltage electrical system is deactivated in the event of an accident which triggers at least one of the restraint systems.

Possible dangers

High-voltage components and high-voltage cables can sustain significant damage in a vehicle fire. Owing to the wide range of damage scenarios, it is not possible to directly indicate the absence of voltage after an accident. The safety technology in the vehicle is activated only if the vehicle electronics detect the failure and can still be technically controlled following an accident. The emergency services are not able to assess the degree of damage to the high-voltage electrical system and associated potentially limited effectiveness of the safety systems. Electrocution can result in involuntary muscle contractions, cardiac arrhythmia, ventricular fibrillation, cardiac arrest, respiratory arrest, burns, or other cell damage. The severity of the injury depends on the amperage, type of current, frequency of the current, exposure time and the path through the human body.

Danger of death

Danger of death owing to $U \geq 30$ V AC voltage or $U \geq 60$ V DC voltage.

Protective measures/rules of conduct

Owing to the presence of electrical energy, adhere to the distances in accordance with DIN VDE 0132 (in Germany) as safe distances during fire fighting.

Carry out fire fighting measures with personal protective equipment and self-contained breathing apparatus.

Avoid touching damaged areas (e.g. damaged or open components, damaged or torn off cables). Use rescue equipment with caution and forethought.

If it is absolutely necessary to carry out rescue measures in areas with damaged high-voltage components, high-voltage cable and high-voltage batteries, cover these with an electrically isolating, flexible cover which is suitable for this purpose (in accordance with IEC 61112).

In case of doubt, manually deactivate the high-voltage electrical system in the vehicle where possible.

Explanations of the indications

Warning



Risk of fire owing to a short circuit in a vehicle which is partially or fully submerged in water. Ensure that the ignition is switched off. Where possible, disconnect all batteries.

Possible dangers

Components corrode after a certain amount of time owing to an electrochemical reaction with water, e.g. electrical cables and printed circuit boards. A short circuit can cause a vehicle fire under some circumstances.

Protective measures/rules of conduct

- Ensure that the ignition is switched off.
- Avoid switching on the ignition as long as the vehicle is partially or fully submerged in water.
- Where possible, disconnect all batteries.

Risk of burns

There is a risk of burns in the event of a vehicle fire owing to a short circuit.

Explanations of the indications

General warning sign



Danger of death owing to electric voltage when towing vehicles with an electric drive.
Do not tow the vehicle by the drive axle. Tow the vehicle with a flatbed vehicle.

Possible dangers

Towing by the drive axle can generate voltage in the high-voltage electrical system in vehicles with electric drives.

Pay attention to vehicles with 4-wheel drive!

Electrocution can result in involuntary muscle contractions, cardiac arrhythmia, ventricular fibrillation, cardiac arrest, respiratory arrest, burns, or other cell damage. The severity of the injury depends on the amperage, type of current, frequency of the current, exposure time and the path through the human body.

Danger of death

Danger of death owing to $U \geq 30$ V.
AC voltage or $U \geq 60$ V DC voltage.

Protective measures/rules of conduct

- In principle, removal of the vehicle from the immediate danger zone at walking speed is always permitted.
- Tow the vehicle with a flatbed vehicle.
- Deactivate the high-voltage electrical system before towing (e.g. switch off the ignition, use high-voltage disconnects where available, disconnect the 12 V battery).
- During handover to the authorities/recovery contractor, they must be informed of the vehicle's drive type and the fire fighting measures taken (e.g. high-voltage deactivation). In particular, they must be informed of a possible risk owing to damaged high-voltage components or high-voltage components which have come into contact with water (e.g. electric shock or fire risk, even delayed, from the high-voltage energy storage system).

More information concerning towing can be found in the vehicle manufacturer's manual.

Explanations of the indications

Warning



Risk of injury owing to severing of compressed gas generators when cutting vehicle parts.
Establish and mark the installation position of the compressed gas generators.
Do not sever compressed gas generators.

Possible dangers

Risk of injury

The compressed gas may escape explosively when compressed gas generators are severed. Loose parts may be thrown out at considerable speed as a result and can cause injuries.

Protective measures/rules of conduct

Mark the installation position of compressed gas generators during the course of the initial investigation. Do not sever compressed gas generators.

Health risk owing to blast injury

A compressed gas generator exploding can generate a very powerful sound pressure wave (up to 170 dB). This can cause acute hearing loss and tinnitus in the vehicle occupants.

Information concerning the number and installation position of compressed gas generators can be found in the vehicle-specific rescue sheet.

Explanations of the indications

Warning



Risk of injury owing to an airbag deploying during the rescue operations.
Disconnect all batteries. Cover vehicle occupants with foil. Use personal protective equipment.
Do not place objects in the deployment area of an airbag. Helpers may not remain in the deployment area of an airbag unnecessarily.

Possible dangers

Danger of death

There is a risk of injury in the deployment area of an airbag which has not deployed or has only partially deployed. Deployment of airbags cannot be excluded if parts of the vehicle are moved significantly or electrical cables are severed with the battery connected during rescue operations. This can result in injuries if someone is in the airbag deployment area. Loose objects and glass fragments may also be thrown at the vehicle occupants involved in the accident or the helpers, causing injuries.

Health risk owing to blast injury

Depending on the type, size and stored gas inflator technology of an airbag, deployment of an airbag can generate a very powerful sound pressure wave (up to 170 dB). This can cause acute hearing loss and tinnitus in the vehicle occupants.

Protective measures/rules of conduct

- Disconnect all batteries. If this is not possible, do not use rescue equipment in the immediate vicinity of an airbag which has not deployed or has only partially deployed.
- Do not place any objects in the deployment area of an airbag which has not deployed or has only partially deployed.
- Cover vehicle occupants with a transparent sheet. Covering with opaque covers or tarpaulins should be avoided wherever possible for psychological reasons.
- Use personal protective equipment.
- Helpers may not unnecessarily remain in the deployment area of an airbag which has not deployed or has only partially deployed.

Information concerning the number and installation position of airbags can be found in the vehicle-specific rescue sheet.

Explanations of the indications

Warning



Risk of injury owing to roll-over protection deploying during rescue operations. Disconnect all batteries. Protect the vehicle occupants with appropriate measures. Use personal protective equipment. Do not place any objects in the deployment area for the roll-over protection. Helpers may not remain in the deployment area for the roll-over protection unnecessarily.

Possible dangers

Risk of injury

There is a risk of injury in the deployment area of roll-over protection which has not deployed. Deployment of roll-over protection cannot be excluded if parts of the vehicle are moved significantly or electrical cables are severed with the battery connected during rescue operations. This can result in injuries if someone is in the roll-over protection deployment area. Loose objects and glass fragments may also be thrown at the vehicle occupants involved in the accident or the helpers, causing injuries.

Protective measures/rules of conduct

- Disconnect all batteries. If this is not possible, do not use rescue equipment in the immediate vicinity of roll-over protection which has not deployed.
- Do not place objects in the deployment area of roll-over protection which has not deployed.
- Protect the vehicle occupants with appropriate measures, according to the situation, before the work.
- Use personal protective equipment.
- Helpers may not unnecessarily remain in the deployment area of roll-over protection which has not deployed.

Information concerning the installation position of roll-over protection can be found in the vehicle-specific rescue sheet.
