











- ① On-board electrical system battery
- ② Additional battery
- ③ High-voltage battery
- ④ High-voltage disconnect device

| | | | | |
|--|--|--|---|--|
|  Airbag |  Generátor plynu |  Predpínač bezpečnostných pásov |  Plynový tlmič, predpätá pružina |  Vystuženie karosérie |
|  Palivová nádrž |  Riadiaci prístroj upútavacích systémov |  Akumulátor 12 V |  Vysokonapäťový akumulátor |  Vysokovoltové komponenty |
|  Vysokovoltové vypínacie zariadenie | | | | |

Upozornenie: Ďalšie informácie nájdete v našej [príručke pre záchranárov](#).



1. Identifikácia/rozpoznanie

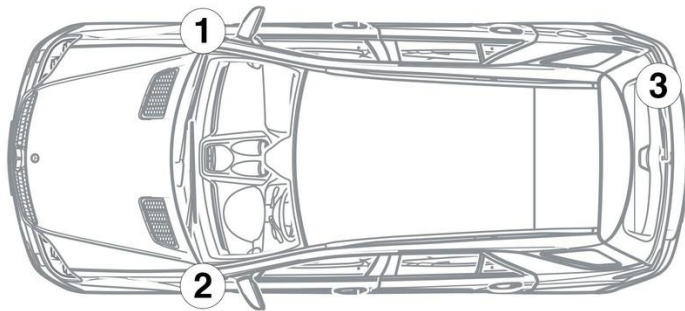

3. Odstránenie priamych rizík/bezpečnostné ustanovenia

Deaktivácia vysokonapäťového systému

Vo všetkých ostatných prípadoch sa musí vysokonapäťový systém deaktivovať takto:

Možnosť 1: Odpojovacie zariadenie vysokého napätia



The high-voltage disconnect device is located on the right at the rear of the high-voltage battery.

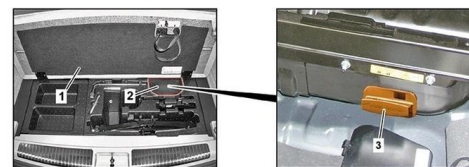

Lift load compartment floor (1) / Remove cover (2) / Push switch (3) to the right and pull off high-voltage battery



Po vypnutí počkajte cca 20 sekúnd, aby sa zaistilo, že nie je prítomné žiadne zvyškové napätie.



Pasívne bezpečnostné systémy, ako sú airbagy a predpínače bezpečnostných pásov, sú napájané napätím z palubnej siete 12 V.



Odpojenie batérie 12 V

1. Odstráňte kryt batérie 12 V.
2. Uvoľnite záporný kábel batérie 12 V na skrutkovom spoji a zaistite ho proti neželanému kontaktu.