



- | | | | | | | | | | |
|---|--------------------------|---|-----------------------|---|--------------------------------|---|-----------------------|---|---------------------------------|
|  | Airbag |  | Generátor plynu |  | Predpínač bezpečnostných pásov |  | Riadiaca jednotka SRS |  | Plynový tlmič, predpätá pružina |
|  | Nízko voltový akumulátor |  | Benzín palivová nádrž | | | | | | |

Upozornenie: Ďalšie informácie nájdete v našej [príručke pre záchranárov](#).



1. Identifikácia/rozpoznanie



2. Imobilizácia/stabilizácia/nadvihnutie

Parkovacia brzda

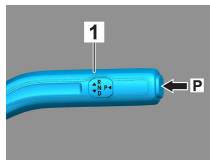

Zaistovacia brzda

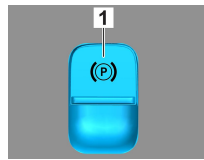
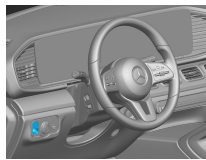

Stlačte spínač P na radiacej páke (1). Parkovacia brzda sa aktivuje automaticky. Elektrická zaistovacia brzda (1)

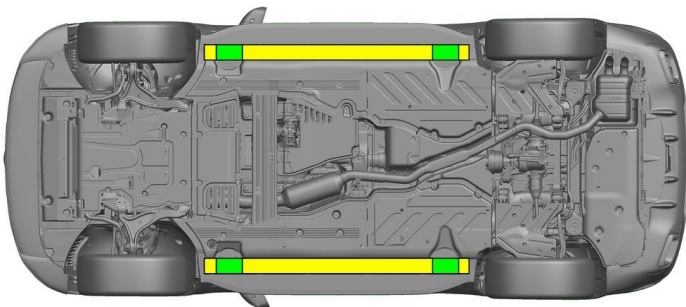

- Vhodné zdvíhacie body
- Vhodné stabilizačné body na strane



Je nutné sa vyhnúť dodatočnej deformácii prahov a podlahy počas záchranu (napr. podopretím pomocou hydraulického vybavenia).

3. Odstránenie priamych rizík/bezpečnostné ustanovenia

Vypnite zapalovanie:

1. Stlačte tlačidlo START-STOP, ale nestláčajte prevádzkovú brzdú.
2. Elektronický kľúč vozidla umiestnite vo vzdialenosti minimálne 5 m.

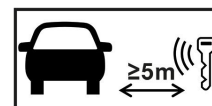

Absencia zvukov motora neznamena, že je vypnuté vozidlo.



Vozidlo môže znovu naštartovať, až kým sa neodstaví z prevádzky.



Odpojenie batérie 12 V/48 V

1. Odstráňte kryt batérie 12/48 V.
2. Uvoľnite záporný kábel batérie 12/48 V na skrutkovom spoji a zaistite ho proti neželanému kontaktu.



Pasívne bezpečnostné systémy (airbagy a predpínače bezpečnostných pásov) sa deaktivujú.



4. Prístup k cestujúcim

Pri vyslobodzovaní cestujúcich treba vziať do úvahy komponenty záchytných systémov (predovšetkým pyrotechnické prvky) podľa údajov na strane 1.

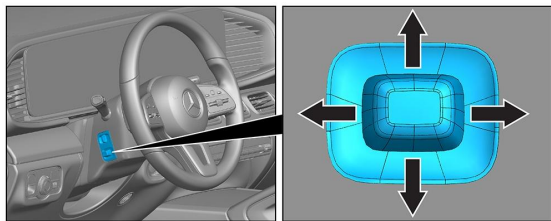

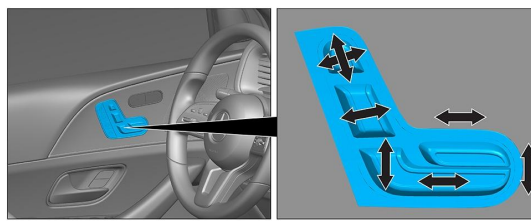

Nastavenie volantu



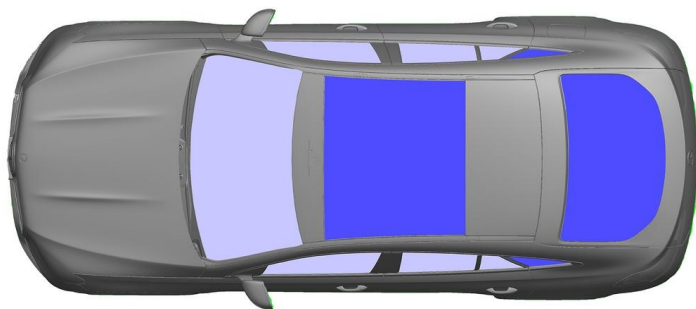











Nastavenie sedadla (elektrické)



 VSG: Vrstvené bezpečnostné sklo

 ESG: Jednovrstvové bezpečnostné sklo

5. Uložená energia/kvapaliny/plyny/pevné látky

	    	12/48V
	 	85L
	  	660 ± 10g

6. V prípade požiaru



Na hasenie horiaceho vozidla použite veľké množstvo vody (H₂O).

7. Vo vode

Nehrozí žiadne nebezpečenstvo, že je karoséria pod napätím. Po záchrane vozidla:

1. Nechajte odtečť vodu z vnútra vozidla.
2. Začnite deaktiváciu palubnej siete 12 V/48 V (pozri kapitolu 3).

8. Odtiahnutie/preprava/skladovanie

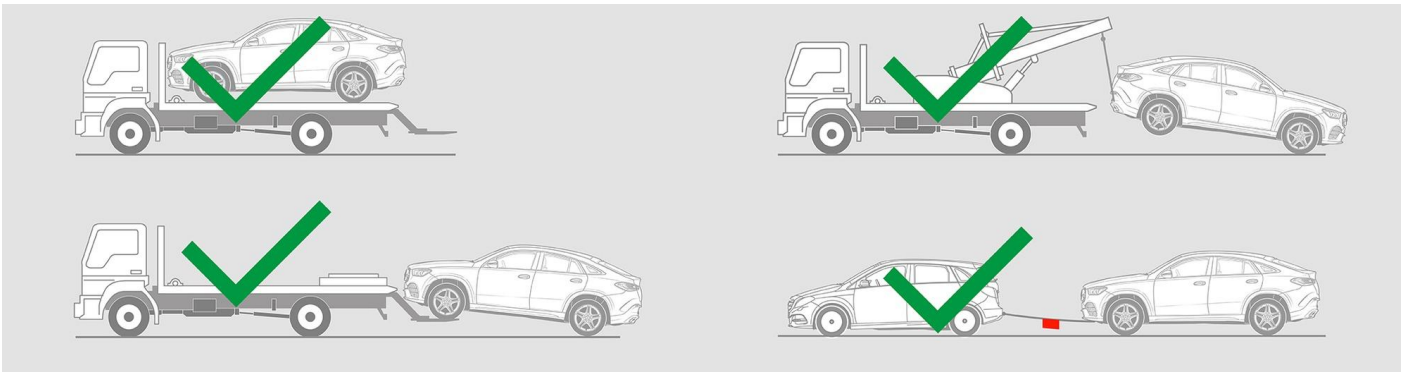

9. Dôležité doplňujúce informácie

Ďalšie informácie nájdete v [Príručke pre odťahovacie služby osobných vozidiel](#).



10. Vysvetlenie použitých piktogramov



Vozidlo na palivo skupiny kvapalín 2



Znak všeobecnej výstrahy



Horľavý



Nebezpečné pre ľudské zdravie



Žieravé materiály



Akútna toxicita



Použitie vody na uhasenie ohňa



Použitie suchej peny na uhasenie ohňa



Použitie vlhkej peny na uhasenie ohňa



Vybrať inteligentný kľúč