











- ① Battery 12 V
- ② High-voltage battery
- ③ High-voltage charge socket
- ④ Onboard loadert
- ⑤ Additional battery

 Airbag	 Generátor plynu	 Predpínač bezpečnostných pásov	 Plynový tlmič, predpätá pružina	 Palivová nádrž
 Riadiaci prístroj upútavacích systémov	 Akumulátor 12 V	 Vysokonapäťový akumulátor	 Vysokovoltové komponenty	 Vysokovoltové vypínacie zariadenie
 Alternatívne vysokovoltové vypínacie zariadenie				

Upozornenie: Ďalšie informácie nájdete v našej [príručke pre záchranárov](#).



### 1. Identifikácia/rozpoznanie

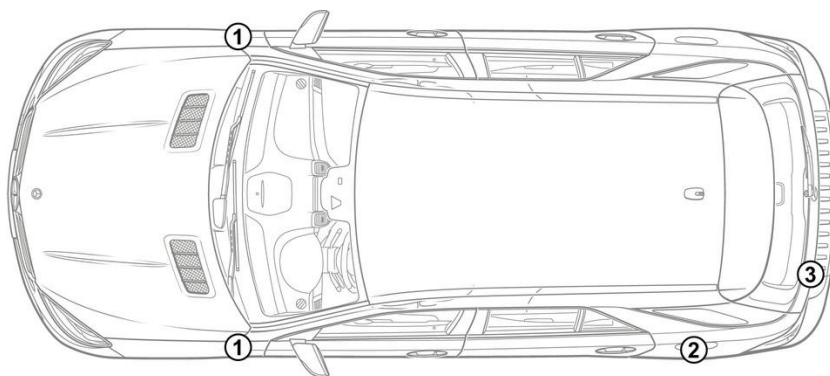

### 3. Odstránenie priamych rizík/bezpečnostné ustanovenia

#### Deaktivácia vysokonapäťového systému

Vo všetkých ostatných prípadoch sa musí vysokonapäťový systém deaktivovať takto:

#### Možnosť 1: Odpojovacie zariadenie vysokého napätia

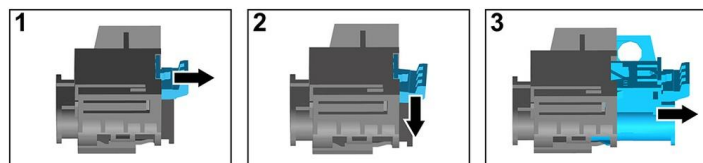
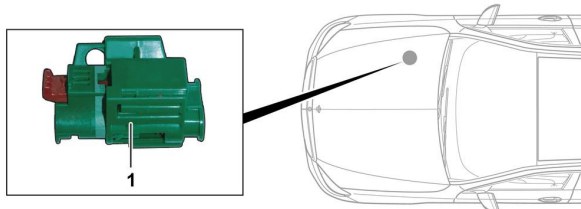

Odpojovacie zariadenie vysokého napätia sa nachádza v priestore motora na strane spolujazdca.



- (1) Potiahnite odblokovanie
- (2) Odblokovanie zatlačte nadol
- (3) Vytiahnite spínač



#### Možnosť 2: Alternatívne odpojovacie zariadenie vysokého napätia

Alternatívne odpojovacie zariadenie vysokého napätia sa nachádza pod krytom poistkovej skrinky na kokpite na strane vodiča. Je označené výstražným štítkom.

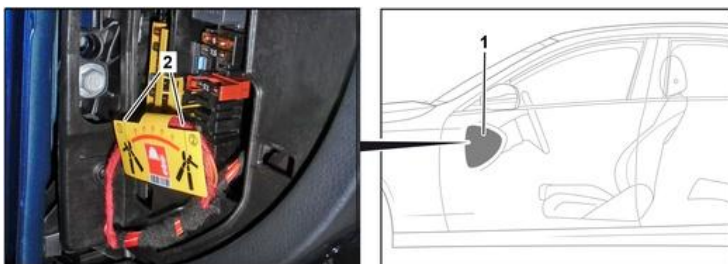

Odstráňte kryt (1). Prerežte vodič na označenom mieste (2).



#### Odpojenie batérie 12 V

- 1. Odstráňte kryt batérie 12 V.
- 2. Uvoľnite záporný kábel batérie 12 V na skrutkovom spoji a zaistite ho proti neželanému kontaktu.

