







① Left-hand drive

② Right-hand drive

-  Airbag
-  Generátor plynu
-  Predpínač bezpečnostných pásov
-  Riadiaca jednotka SRS
-  Plynový tlmič, predpätá pružina
-  Nízko voltový akumulátor
-  Benzín palivová nádrž

Upozornenie: Ďalšie informácie nájdete v našej [príručke pre záchranárov](#).



1. Identifikácia/rozpoznanie

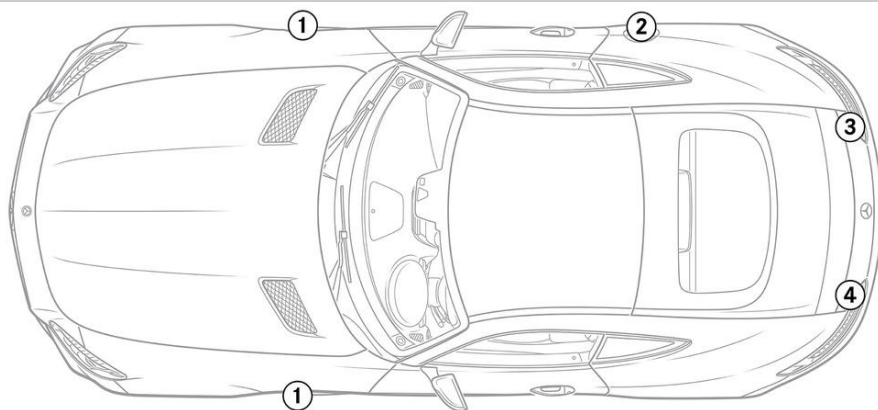

1

V8 BITURBO

2

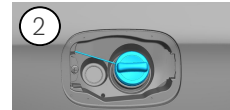

3

GT

4

