













- |   |                                     |   |                              |   |   |   |                                    |   |  |
|---|-------------------------------------|---|------------------------------|---|---|---|------------------------------------|---|--|
|  | Airbag                              |  | Generator de gaz             |  | Sistem de pre-tensionare a centurilor de siguranță                |  | Unitate de control SRS             |  | Sistem activ de protecție a pietonilor     |
|  | Amortizor cu gaz / arc pretensionat |  | Acumulator de joasă tensiune |  | Motorină Rezervor de combustibil                                  |  | Pachet de baterii, înaltă tensiune |  | Cablu de alimentare pentru tensiune înaltă |
|   | Componentă de înaltă tensiune       |  | Înteruperea cablurilor       |  | Dispozitiv de joasă tensiune pentru deconectarea tensiunii înalte |   |                                    |   |  |

Indicație: Pentru mai multe informații, vă rugăm să consultați ghidurile [operationale de salvare](#).



### 1. Identificare / recunoaștere

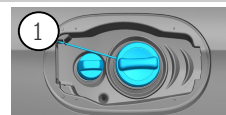

3

4

C 300de 4MATIC

### 2. Imobilizare / stabilizare / ridicare

#### Frână de staționare

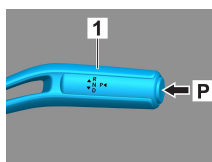
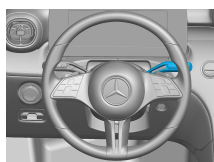

#### Frână de parcare

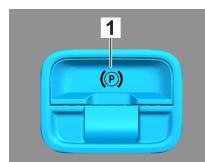

Apăsați comutatorul P pe maneta de selectare  
(1). Frâna de staționare este activată automat.

Frână de parcare electrică (1)

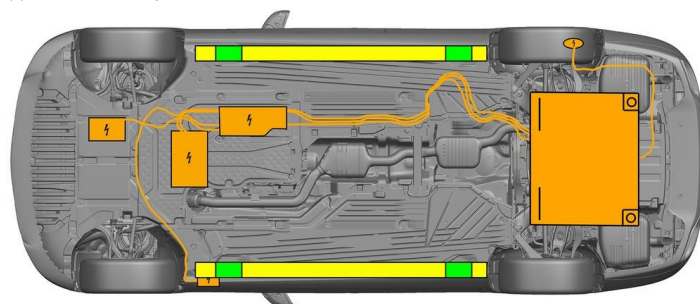

Puncte de ridicare adecvate



Puncte de stabilizare adecvate pe lateral



Baterie de înaltă tensiune



Trebuie să se evite deformarea suplimentară a pragurilor și a șasiului în timpul operațiunii de salvare (de ex. prin susținere cu echipament hidraulic).

### 3. Înlăturare pericole / reguli de securitate

#### Decuplați aprinderea:

1. Apăsați butonul START-STOP fără a acționa frâna de serviciu.
2. Păstrați cheia electronică a vehiculului la o distanță de cel puțin 5 m.

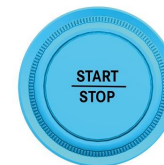
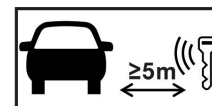

Absența zgomotului motorului nu înseamnă că vehiculul este oprit.



O repornire este posibilă până când vehiculul este scos din funcțiune.

#### Dezactivarea sistemului de înaltă tensiune



În cazul accidentelor care implică declanșarea airbagurilor și a sistemelor de pretensionare a centurilor de siguranță, sistemul de înaltă tensiune se decuplează automat.





În toate celelalte cazuri, sistemul de înaltă tensiune se dezactivează după cum urmează:

### Opțiune 1: Dispozitiv de deconectare a înaltei tensiuni

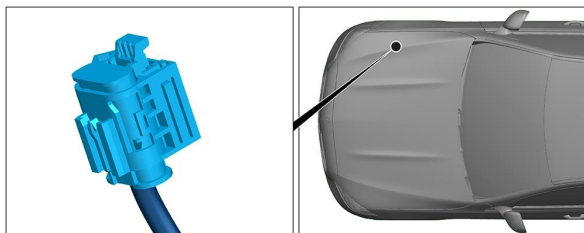

Dispozitivul de deconectare de înaltă tensiune se află în camera motorului pe partea pasagerului.



- (1) Trageți mecanismul de deblocare
- (2) Apăsați mecanismul de deblocare în jos
- (3) Scoateți comutatorul



### Opțiune 2: Dispozitiv alternativ de deconectare a înaltei tensiuni

Dispozitivul alternativ de deconectare de înaltă tensiune se află sub capacul cutiei de siguranțe din cabina de pilotaj, pe partea șoferului. Este marcat cu o plăcuță indicatoare.

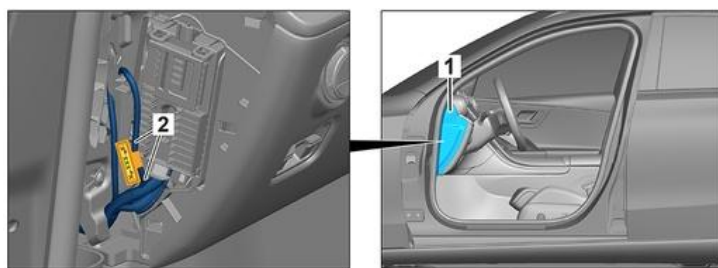

Îndepărtați capacul (1). Tăiați cablul în punctul marcat (2).



Pentru a vă asigura că nu mai există tensiune reziduală în rețeaua de înaltă tensiune, așteptați aproximativ 20 de secunde după dezactivare.



Sistemele de siguranță pasivă, cum ar fi airbagurile și sistemele de pretensionare a centurilor de siguranță, sunt alimentate în continuare cu tensiune de către rețeaua de bord de 12 V.



### Deconectați bateria de 12 V/48 V

1. Îndepărtați capacul bateriei de 12 V/48 V din camera motorului.
2. Slăbiți cablul minus al bateriei de 12 V/48 V la conexiunea cu șurub și asigurați-l împotriva contactului nedorit.



Sistemele de siguranță pasivă (airbagurile și sistemele de pretensionare a centurilor de siguranță) sunt dezactivate.



## 4. Accesul către ocupanți

La eliberarea ocupanților autovehiculului, trebuie să se țină seama de componentele sistemelor de siguranță pasivă (în special elementele pirotehnice), conform indicațiilor specificate la pagina 1.

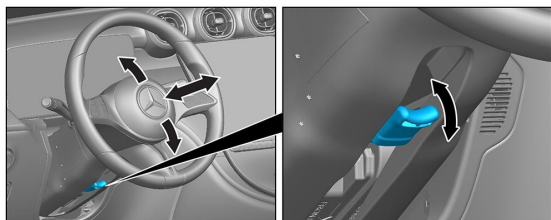

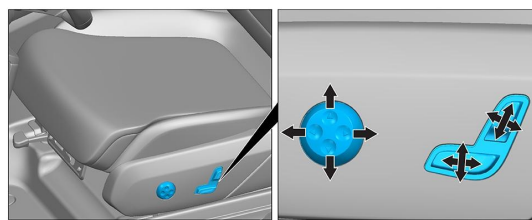

Reglarea volanului

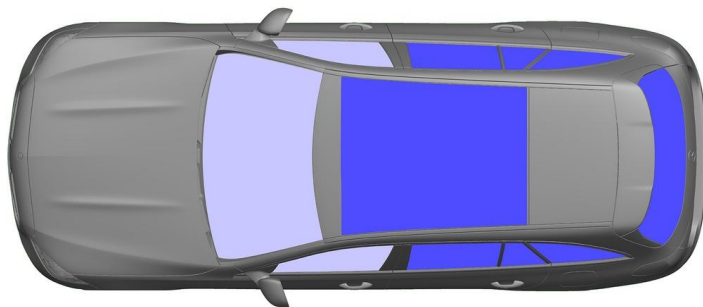

Reglarea scaunului (electrică)



 VSG: Sticlă securizată laminată  
 ESG: Sticlă securizată cu o singură foaie

## 5. energie stocată / lichide / gaze / solide

	    	12/48V
	     	400V
	 	50L
	  	610 ± 10g



Toate cablurile de înaltă tensiune sunt prevăzute cu izolație de culoare portocalie.

## 6. În caz de incendiu



Pentru a stinge un incendiu la vehicul utilizați cantități mari de apă (H<sub>2</sub>O).  
Pentru a răci bateria Li-ion utilizați cantități mai mari de apă (H<sub>2</sub>O).



Avertizare: Reapinderea bateriei



Dacă lichidul de răcire se scurge din bateria de înaltă tensiune, aceasta poate deveni instabilă din cauza suprasolicității termice. Verificați temperatura bateriei cu o cameră de termoviziune IR.



## 7. În cazul submersiei

Nu există niciun pericol de tensiune la caroserie.

După recuperarea vehiculului:

1. Lăsați să se scurgă apa din habitacul.
2. Inițiați dezactivarea sistemului de înaltă tensiune (a se vedea capitoul 3).



## 8. Tractare / transport / depozitare

Transportați vehiculul numai cu ambele osii pe un vehicul de tractare sau pe un transportor de autovehicule.

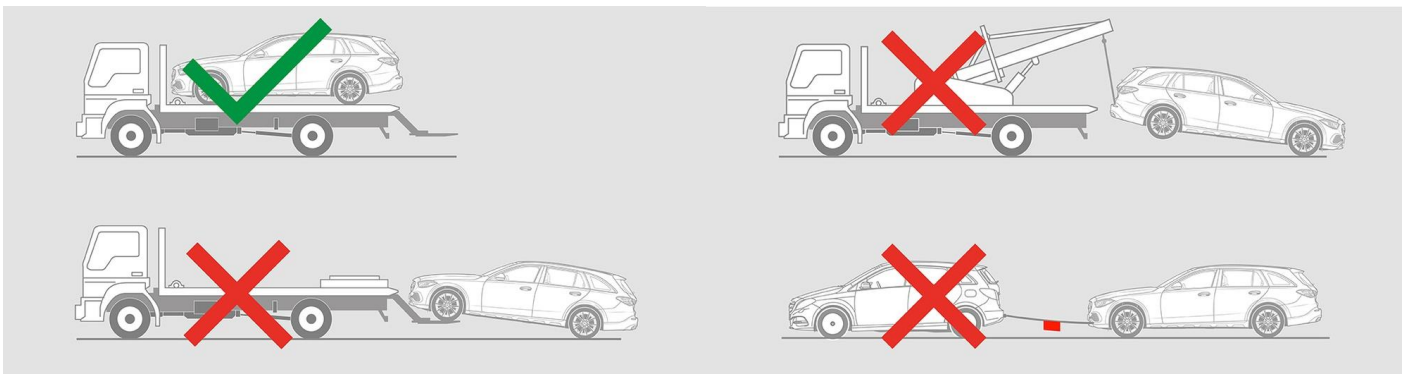

Păstrați o distanță sigură față de alte vehicule.



Avertizare: Reapriinderea bateriei



## 9. Informații adiționale importante

Mai multe informații puteți găsi în [Liniiile directe pentru serviciile de tractare a autoturismelor](#).

## 10. Explicarea pictogramelor utilizate



Vehicul electric hibrid alimentat cu combustibil din grupa de flui-de 1



Simbol de avertizare generală



Avertisment, electricitate



Inflamabil



Periculos pentru sănătatea umană



Coroziv



Toxicitate acută



Exploziv



Folosiți apă pentru a stinge incendiul



Utilizați camera termică cu infraroșu



Capotă



Îndepărtați cheia inteligentă



Componentă a sistemului de aer condiționat



Avertisment; temperatură scăzută