













- | | | | | | | | | | |
|-------------------------------------------------------------------------------------|-------------------------------------------|-------------------------------------------------------------------------------------|---------------------------|-------------------------------------------------------------------------------------|---------------------------------------------------------------------|-------------------------------------------------------------------------------------|-------------------------|---------------------------------------------------------------------------------------|----------------------------------------|
|  | Airbag |  | Gerador de gás |  | Pré-tensor do cinto de segurança |  | Unidade de controlo SRS |  | Sistema de proteção de pedestres ativo |
|  | Mola de pressão a gás/mola pré-tensionada |  | Bateria de baixa voltagem |  | Diesel reservatório de combustível |  | Bateria de alta tensão |  | Cabo de alimentação de alta tensão |
|  | Componente de alta tensão |  | Corte de cabo |  | Dispositivo de baixa tensão que desconecta o sistema de alta tensão | | | | |

Indicação: Para mais informações, por favor consulte o nosso [guia de salvamento](#).



1. Identificação / reconhecimento

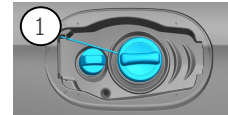

C 300de 4MATIC

2. Imobilização / estabilização / levantamento

Travão de estacionamento

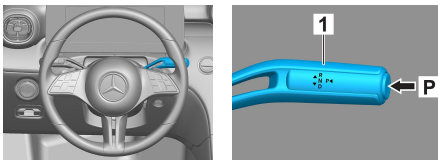

Travão de estacionamento

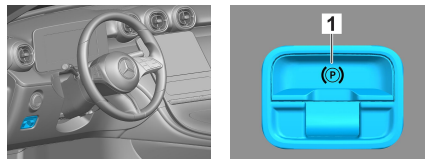

Pressionar o interruptor P na alavanca de seleção (1). O travão de estacionamento é ativado automaticamente.

Travão de estacionamento elétrico (1)

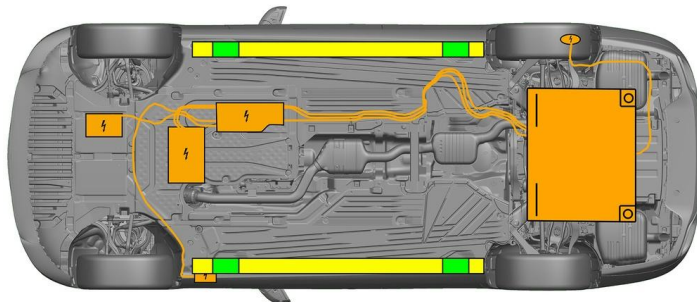

- Pontos de elevação adequados
- Pontos de estabilização adequados no lado
- Bateria de alta voltagem



Deve ser evitada uma deformação adicional das soleiras e da estrutura de suporte do piso durante o salvamento (p. ex., através de apoio com equipamento hidráulico).

3. Neutralização dos principais perigos / regras de segurança

Desligar a ignição:

1. Pressionar a tecla START-STOP sem acionar o travão de serviço.
2. Manter as chaves eletrónicas do veículo a pelo menos 5 m de distância.

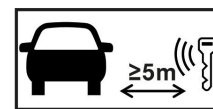

A ausência de sons do motor não significa que o veículo esteja desligado.



Um reinício é possível até o veículo ser retirado de serviço.

Desativação do sistema de alta voltagem



Em acidentes nos quais os airbags e os pré-tensores dos cintos de segurança sejam acionados, o sistema de alta voltagem é automaticamente desligado.





Em todos os outros casos, desativar o sistema de alta voltagem da seguinte forma:

Opção 1: Dispositivo de desconexão de alta voltagem

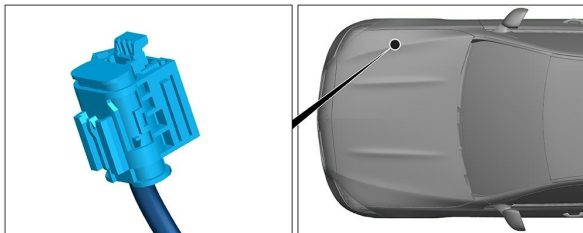

O dispositivo de desconexão de alta voltagem encontra-se no compartimento do motor no lado do acompanhante.



- (1) Puxar o desbloqueio
- (2) Pressionar o desbloqueio para baixo
- (3) Remover o interruptor



Opção 2: Dispositivo de desconexão de alta voltagem alternativo



O dispositivo de desconexão de alta voltagem alternativo encontra-se por baixo da cobertura da caixa de fusíveis no cockpit no lado do condutor. É assinalado com um sinal.

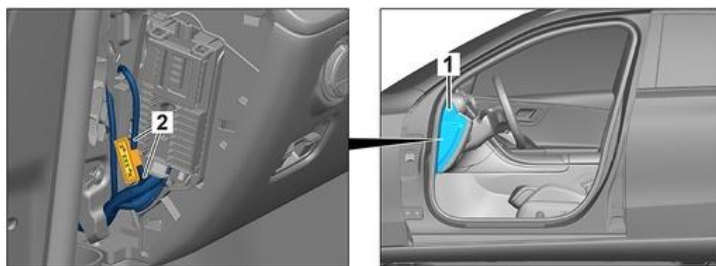

Retirar a cobertura (1). Cortar o cabo no lugar marcado (2).



Para garantir que não há tensão residual na rede de alta voltagem, aguardar cerca de 20 segundos após desligar.



Os sistemas de segurança passivos tais como airbags e pré-tensores de cintos de segurança continuam a ser alimentados com tensão pela rede de bordo de 12 volts.



Desconectar a bateria de 12 V / 48 V



1. Retirar a cobertura das baterias de 12/48 volts no compartimento do motor.
2. Soltar o cabo negativo da bateria de 12/48 volts na união roscada e proteger contra contacto involuntário.



Os sistemas de segurança passivos (airbags e pré-tensores de cintos de segurança) são desativados.



4. Acesso aos ocupantes

Os componentes dos sistemas de retenção (particularmente os elementos pirotécnicos) devem ser tidos em consideração quando os ocupantes saírem do veículo, de acordo com as indicações na página 1.





Ajuste do volante



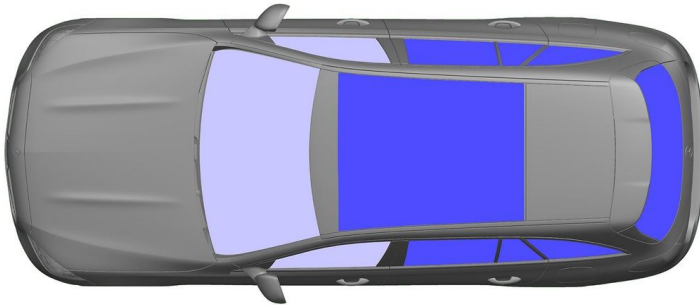

















Ajuste do assento (elétrico)



 VSG: vidro de segurança laminado
 ESG: vidro de segurança temperado

5. Armazenamento de energia / líquidos / gases / sólidos

| | | |
|-------------------------------------------------------------------------------------|-------------------------------------------------------------------------------------------------------------------------------------------------------------------------------------------------------------------------------------------------------------------------------------------------------------------------------------------------------------------------------------------------------------------------------------|-----------|
|  |      | 12/48V |
|  |      | 400V |
|  |   | 50L |
|  |    | 610 ± 10g |



Todos os cabos de alta tensão dispõem de um isolamento laranja.

6. Em caso de incêndio



Utilizar grandes quantidades de água (H₂O) para extinguir um incêndio num veículo.
Utilizar grandes quantidades de água (H₂O) para arrefecer a bateria de iões de lítio.



Aviso: Acionar de novo a bateria



Se o refrigerante verter da bateria de alta tensão, esta pode tornar-se instável devido a sobrecarga térmica. Verifique a temperatura da bateria com uma câmara termográfica de infravermelhos.



7. Em caso de submersão

Não há perigo de ser aplicada tensão à carroçaria.

Após o resgate do veículo:

1. Deixar escoar a água do interior.
2. Iniciar a desativação do sistema de alta tensão (ver capítulo 3).



8. Reboque / transporte / estacionamento

Apenas transportar o veículo com ambos os eixos sobre um veículo de reboque ou um porta carros.

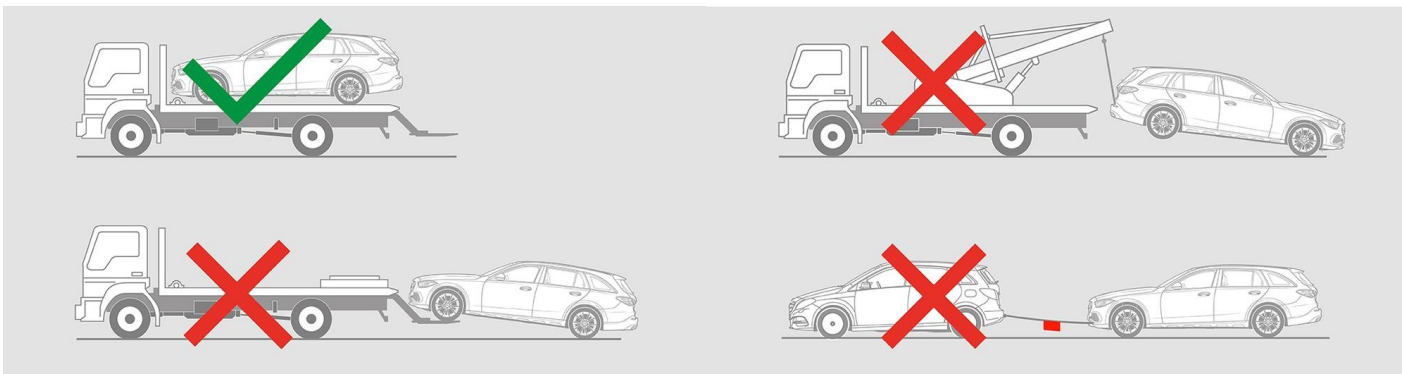

Manter a uma distância segura de outros veículos.

| | | |
|--|----------------------------------|--|
| | Aviso: Acionar de novo a bateria | |
|--|----------------------------------|--|

9. Informação adicional importante

Para mais informações, veja o [Guia para serviços de reboque para veículo de passageiros](#).

10. Explicação dos pictogramas usados

| | | | | | | | |
|--|---------------------------------------------------|--|---------------------------------------------|--|------------------------|--|-------------------|
| | Veículo elétrico híbrido a combustível do grupo 1 | | Advertência geral | | Cuidado, electricidade | | Inflamável |
| | Perigoso para a saúde humana | | Corrosivo | | Toxicidade aguda | | Explosivo |
| | Usar água para extinguir o fogo | | Usar câmera de imagem térmica infravermelha | | Capô | | Remover smart key |
| | Componente de ar-condicionado | | Cuidado; baixa temperatura | | | | |