

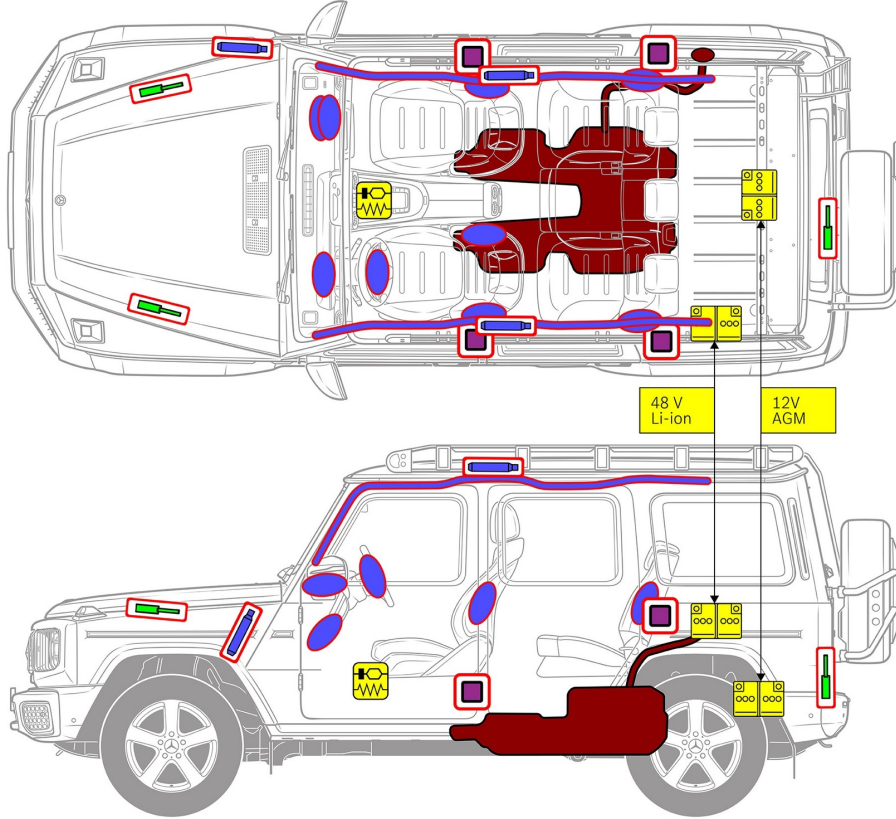









Mercedes-Benz Classe G 450d/500/550 veículo todo-o-terreno (W465), a partir de 2024



- 
Airbag
- 
Gerador de gás
- 
Pré-tensor do cinto de segurança
- 
Unidade de controlo SRS
- 
Mola de pressão a gás/mola pré-tensionada
- 
Bateria de baixa voltagem
- 
Gasolina reservatório de combustível



1. Identificação / reconhecimento



2
G 450 d

3
G 500

4
G 550

2. Imobilização / estabilização / levantamento

Travão de estacionamento

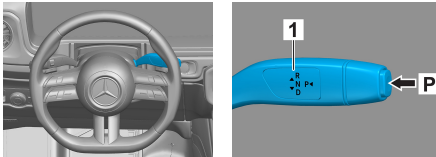

Pressionar o interruptor P na alavanca de seleção (1). O travão de estacionamento é ativado automaticamente.

Travão de estacionamento



Travão de estacionamento elétrico (1)

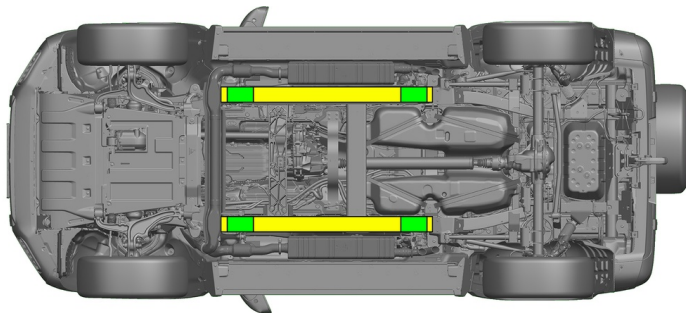

Pontos de elevação adequados



Pontos de estabilização adequados no lado



Deve ser evitada uma deformação adicional das soleiras e da estrutura de suporte do piso durante o salvamento (p. ex., através de apoio com equipamento hidráulico).

3. Neutralização dos principais perigos / regras de segurança

Desligar a ignição:

1. Pressionar a tecla START-STOP sem acionar o travão de serviço.
2. Manter as chaves eletrónicas do veículo a pelo menos 5 m de distância.

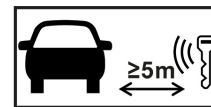

A ausência de sons do motor não significa que o veículo esteja desligado.



Um reinício é possível até o veículo ser retirado de serviço.



Desconectar a bateria de 48 V



1. Remover a placa do assoalho do porta-malas (desparafusar os 4 olhais de amarração), em seguida, remover os diversos revestimentos (coluna C, coluna D, linha inferior da janela etc), e o revestimento da parede lateral para garantir o acesso para a bateria de 48 volts.
2. Soltar o cabo negativo da bateria de 48 volts na união roscada e proteger contra contato acidental.



Desconectar a bateria de 12 V



1. Remover a placa do assoalho do porta-malas (desparafusar os 4 olhalis de amarração) para garantir o acesso para a bateria de 12 volts.
2. Soltar o cabo negativo da bateria de 12 volts na união roscada e proteger contra contato acidental.



Os sistemas de segurança passivos (airbags e pré-tensores de cintos de segurança) são desativados.

4. Acesso aos ocupantes

Ao libertar os passageiros, as áreas da carroçaria constituídas por aços de alta resistência e os componentes dos sistemas de retenção (em particular elementos pirotécnicos) devem ser tidas em conta de acordo com as informações da página 1.

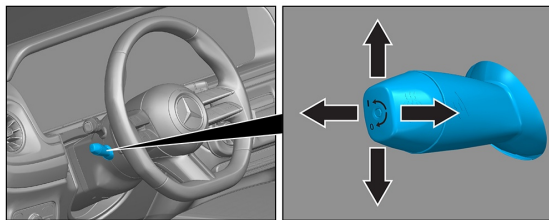

Ajuste do volante

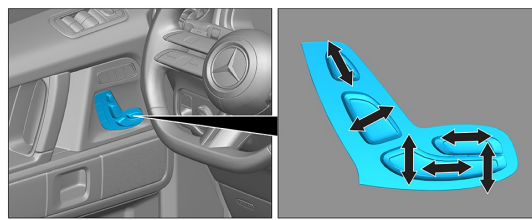

Ajuste do assento (elétrico)

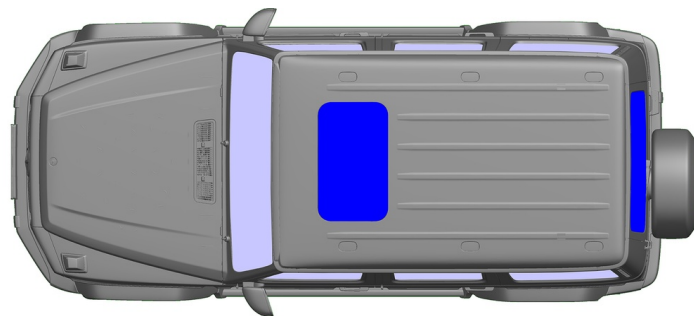

VSG: vidro de segurança laminado

ESG: vidro de segurança temperado

5. Armazenamento de energia / líquidos / gases / sólidos

		12 V/ 48 V
		100 L
		100 L
		680 ± 10 g

6. Em caso de incêndio



Utilizar grandes quantidades de água (H₂O) para extinguir um incêndio num veículo.

7. Em caso de submersão

Não há perigo de ser aplicada tensão à carroçaria. Após o resgate do veículo:

1. Deixar escoar a água do interior.
2. Iniciar a desativação da rede de bordo de 12/48 V (ver capítulo 3).



8. Reboque / transporte / estacionamento

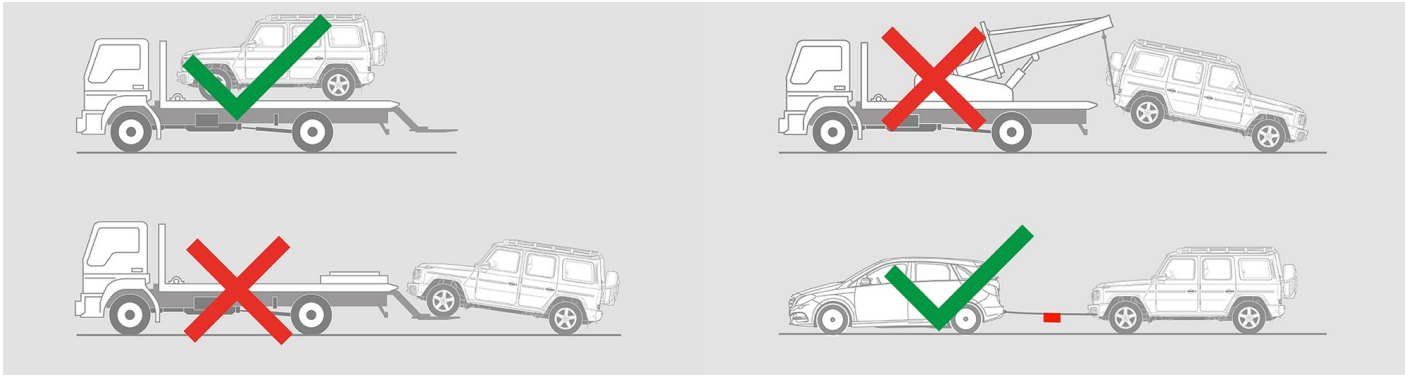

9. Informação adicional importante

Para mais informações, veja o [Guia para serviços de reboque para veículo de passageiros](#).

Indicação: Para mais informações, por favor consulte o nosso [guia de salvamento](#).

10. Explicação dos pictogramas usados



Veículo a combustível do grupo 1



Veículo a combustível do grupo 2



Advertência geral



Inflamável



Perigoso para a saúde humana



Corrosivo



Toxicidade aguda



Explosivo



Usar água para extinguir o fogo



Usar espuma seca para extinguir o fogo



Usar espuma aquosa para extinguir o fogo



Porta-malas



Remover smart key



Componente de ar-condicionado



Cuidado; baixa temperatura