











- | | | | | | | | | | |
|---|---|---|---|---|----------------------------------|---|---------------------------|---|--|
|  | Airbag |  | Gerador de gás |  | Pré-tensor do cinto de segurança |  | Unidade de controlo SRS |  | Sistema de proteção de pedestres ativo |
|  | Sistema de proteção no caso de capotamento automático |  | Mola de pressão a gás/mola pré-tensionada |  | Reforço da carroceria |  | Bateria de baixa voltagem |  | Gasolina reservatório de combustível |

Indicação: Para mais informações, por favor consulte o nosso [guia de salvamento](#).



1. Identificação / reconhecimento

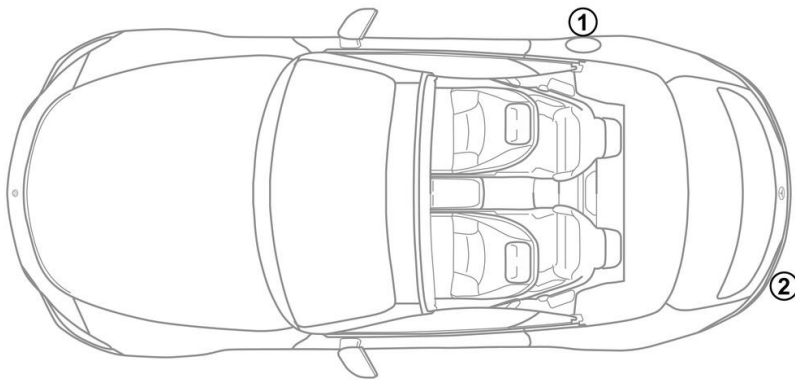

2. Imobilização / estabilização / levantamento

Travão de estacionamento

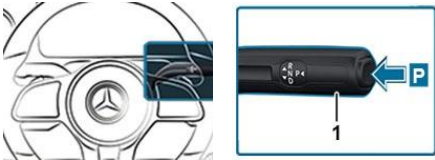

Travão de estacionamento

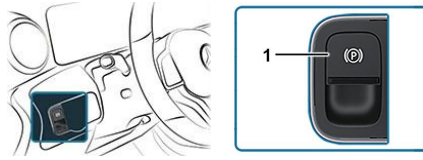

Pressionar o interruptor P na alavanca de seleção (1). O travão de estacionamento é ativado automaticamente.

(1) Travão de estacionamento elétrico

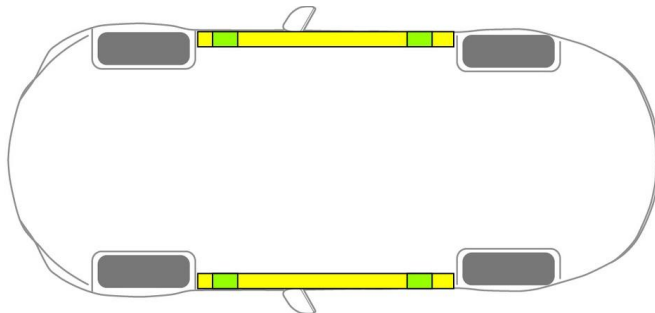

Pontos de elevação adequados



Pontos de estabilização adequados no lado



Deve ser evitada uma deformação adicional das soleiras e da estrutura de suporte do piso durante o salvamento (p. ex., através de apoio com equipamento hidráulico).

3. Neutralização dos principais perigos / regras de segurança

Desligar a ignição:

1. Pressionar a tecla START-STOP sem acionar o travão de serviço.
2. Manter as chaves eletrónicas do veículo a pelo menos 5 m de distância.



A ausência de sons do motor não significa que o veículo esteja desligado.



Um reinício é possível até o veículo ser retirado de serviço.



Desconectar a bateria de 48 V

1. Retirar a cobertura das baterias de 48 volts no compartimento do motor.
2. Soltar o cabo negativo da bateria de 48 volts na união roscada e proteger contra contacto involuntário.



Os sistemas de segurança passivos (airbags e pré-tensores de cintos de segurança) são desativados.



Desconectar a bateria de 12 V



1. Retirar a cobertura das baterias de 12 volts no porta-malas.
2. Soltar o cabo negativo da bateria de 12 volts na união roscada e proteger contra contacto involuntário.

4. Acesso aos ocupantes

Ao libertar os passageiros, as áreas da carroçaria constituídas por aços de alta resistência e os componentes dos sistemas de retenção (em particular elementos pirotécnicos) devem ser tidas em conta de acordo com as informações da página 1.

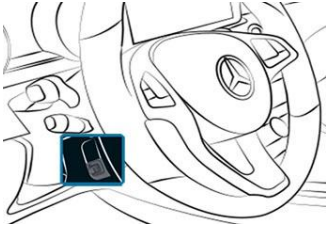

Ajuste do volante



Ajuste do assento

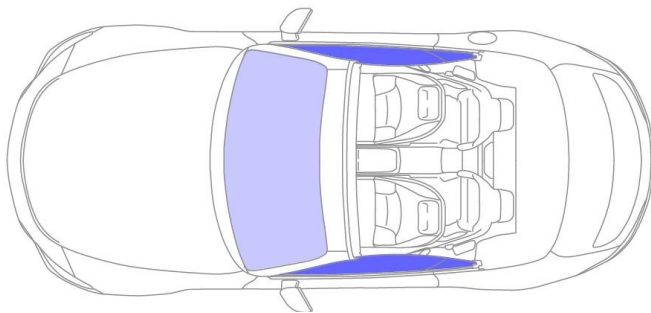

- VSG: vidro de segurança laminado
- ESG: vidro de segurança temperado

5. Armazenamento de energia / líquidos / gases / sólidos



6. Em caso de incêndio



Utilizar grandes quantidades de água (H₂O) ou espuma para extinguir um incêndio num veículo.

7. Em caso de submersão

Não há perigo de ser aplicada tensão à carroçaria.

Após o resgate do veículo:

1. Deixar escoar a água do interior.
2. Iniciar a desativação da rede de bordo de 12 V / 48 V (ver capítulo 3).

8. Reboque / transporte / estacionamento

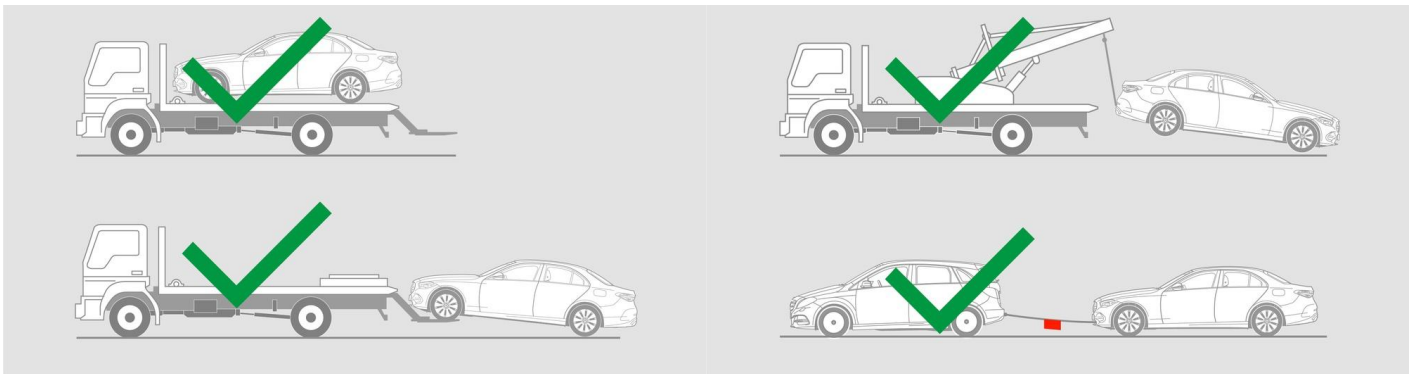

Manter a uma distância segura de outros veículos.



9. Informação adicional importante

Para mais informações, veja o "Guia para serviços de reboque para veículo de passageiros".

10. Explicação dos pictogramas usados



Veículo a combustível do grupo 1



Veículo a combustível do grupo 2



Advertência geral



Inflamável



Perigoso para a saúde humana



Corrosivo



Toxicidade aguda



Usar água para extinguir o fogo



Usar espuma seca para extinguir o fogo



Usar espuma aquosa para extinguir o fogo



Capô



Porta-malas



Remover smart key