













- ① Bateria do sistema elétrico do veículo
- ② Bateria suplementar
- ③ Bateria de alta voltagem
- ④ Tomada de recarga de alta voltagem
- ⑤ Dispositivo de corte de alta voltagem
- ⑥ Dispositivo de corte de alta voltagem alternativo

 Airbag	 Gerador de gás	 Pré-tensor do cinto de segurança	 Amortecedor de pressão de gás	 Depósito de combustível
 Unidade de comando dos sistemas de retenção	 Bateria 12 V	 Bateria de alta voltagem	 Componentes de alta voltagem	 Dispositivo de corte de alta voltagem
 Dispositivo de corte de alta voltagem alternativo	 Proteção para pedestres			

Indicação: Para mais informações, por favor consulte o nosso [guia de salvamento](#).



1. Identificação / reconhecimento

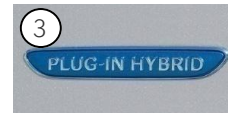
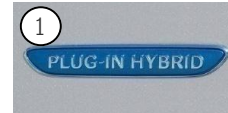
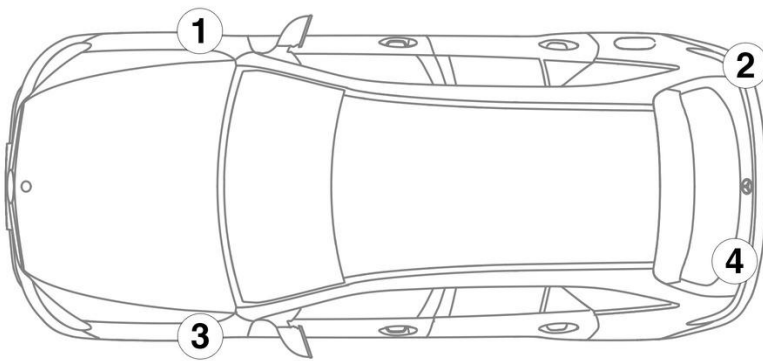

3. Neutralização dos principais perigos / regras de segurança

Desativação do sistema de alta voltagem

Em todos os outros casos, desativar o sistema de alta voltagem da seguinte forma:

Opção 1: Dispositivo de desconexão de alta voltagem

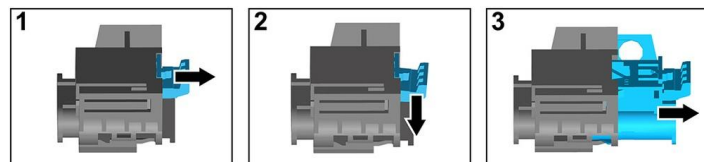
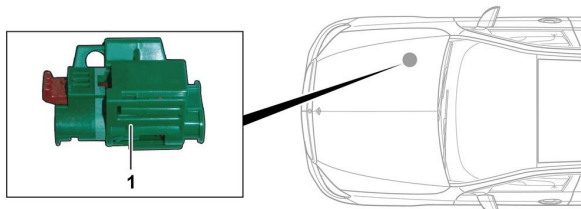

O dispositivo de desconexão de alta voltagem encontra-se no compartimento do motor no lado do acompanhante.



- (1) Puxar o desbloqueio
- (2) Pressionar o desbloqueio para baixo
- (3) Remover o interruptor



Opção 2: Dispositivo de desconexão de alta voltagem alternativo

O dispositivo de desconexão de alta voltagem alternativo encontra-se por baixo da cobertura da caixa de fusíveis no cockpit no lado do condutor. É assinalado com um sinal.

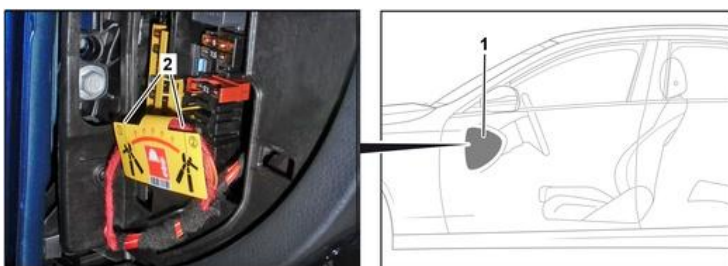

Retirar a cobertura (1). Cortar o cabo no lugar marcado (2).



Desconectar a bateria de 12 V

1. Retirar a cobertura das baterias de 12 volts.
2. Soltar o cabo negativo da bateria de 12 volts na união rosca e proteger contra contacto involuntário.

