













- ① Bateria de alta voltagem (direção à esquerda)
- ② Bateria de alta voltagem (direção à direita)
- ③ Bateria principal de 12 V
- ④ Bateria adicional de direção à esquerda (opcional)
- ⑤ Bateria adicional de direção à direita (opcional)
- ⑥ Dispositivo de desligamento de alta voltagem

 Airbag	 Gerador de gás	 Pré-tensionadores do cinto de segurança	 Mola de pressão a gás	 Reforço da carroceria
 Reservatório de combustível	 Módulo de comando dos sistemas de retenção	 Bateria 12 V	 Bateria de alta voltagem	 Componentes de alta voltagem
 Dispositivo de desligamento de alta voltagem	 Proteção de pedestres			

Indicação: Para informações adicionais, favor consultar o nosso [guia de salvamento](#).



1. Identificação / reconhecimento

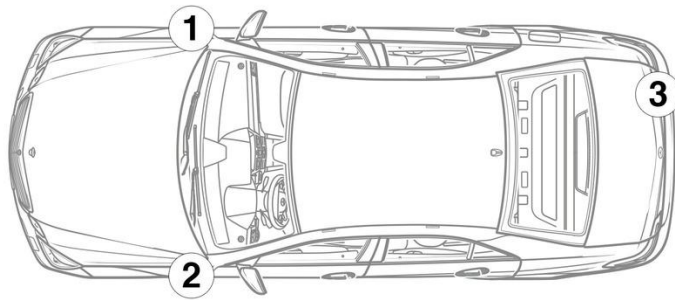

3. Neutralização dos principais perigos / regras de segurança

Desativação do sistema de alta voltagem

Em todos os outros casos, desativar a rede de bordo de alta voltagem da seguinte forma:

Opção 1: Dispositivo de desconexão de alta voltagem

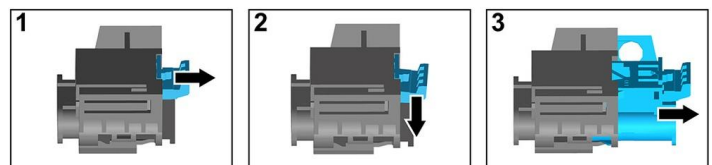
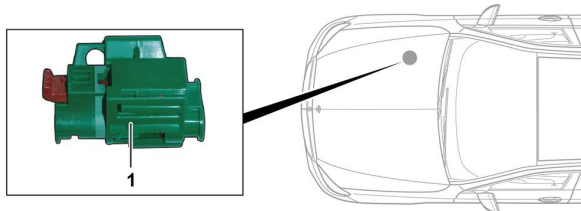

Die Hochvolt-Abschaltvorrichtung befindet sich im Motorraum auf der Beifahrerseite.



- (1) Puxar o destravamento
- (2) Pressionar o destravamento para baixo
- (3) Retirar o interruptor



Opção 2: Dispositivo de desconexão de alta voltagem alternativo

O dispositivo de desligamento de alta voltagem alternativo se encontra sob a cobertura da caixa de fusíveis no posto de comando no lado do motorista.

Este está identificado com uma plaqueta de informações.

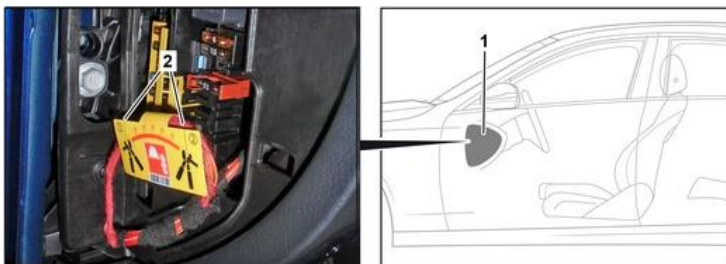

Remover a cobertura (1). Cortar o cabo no local assinalado (2).



Desconectar a bateria de 12 V

- 1. Remover a cobertura da bateria de 12 V.
- 2. Soltar o cabo negativo da bateria de 12 V na união roscada e proteger contra contato não intencional.

