

- Airbag
- Gerador de gás
- Pré-tensionadores do cinto de segurança
- Módulo de comando SRS
- Mola de pressão a gás/mola pré-tensionada
- Bateria de baixa voltagem
- Reservatório de combustível gasolina
- Bateria de alta tensão
- Cabo de alta tensão
- Componente de alta tensão
- Ponto de separação do cabo
- Separação de alta voltagem no ponto de separação de baixa voltagem

Indicação: Para informações adicionais, favor consultar o nosso [guia de salvamento](#).

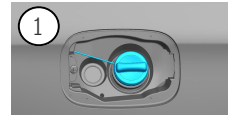

1. Identificação / reconhecimento



GLE 400e

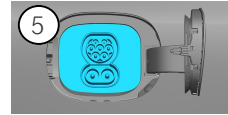
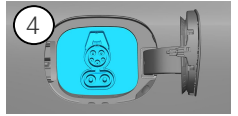

2. Imobilização / estabilização / levantamento

Freio de estacionamento

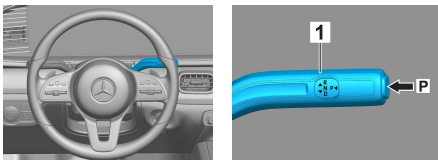

Freio de estacionamento

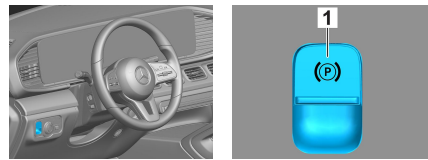

Pressionar o interruptor P na alavanca seletora (1).

Freio de estacionamento elétrico (1)

O freio de estacionamento é ativado automaticamente.

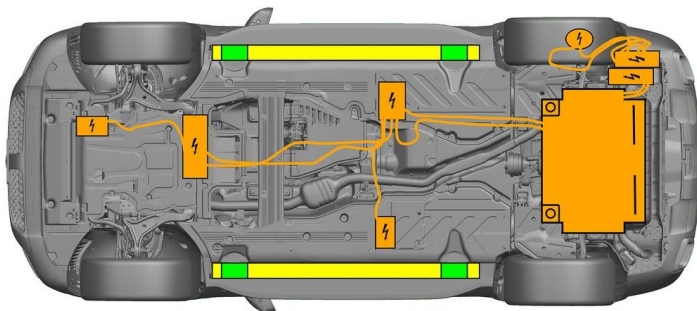

Pontos de elevação adequados

Pontos de estabilização adequados na lateral



Deve-se evitar uma deformação adicional das soleiras e do lado inferior do assoalho durante o resgate (por exemplo, por meio de suporte com equipamento hidráulico).

3. Neutralização dos principais perigos / regras de segurança

Desligar a ignição:

1. Pressionar a tecla START-STOP sem acionar o freio de serviço.
2. Manter a chave eletrônica do veículo em uma distância de pelo menos 5 m.



A ausência de ruídos do motor não significa que o veículo está desligado.



Uma nova partida é possível até que o veículo seja descomissionado.

Desativação do sistema de alta voltagem



Em acidentes com acionamento de airbags e pré-tensionadores dos cintos de segurança, a rede de bordo de alta voltagem é desligada automaticamente.





Em todos os outros casos, desativar a rede de bordo de alta voltagem da seguinte forma:

Opção 1: Dispositivo de desconexão de alta voltagem

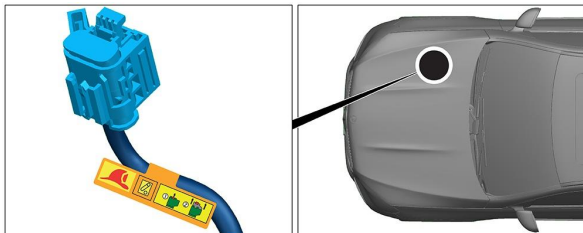

Die Hochvolt-Abschaltvorrichtung befindet sich im Motorraum auf der Beifahrerseite.



- (1) Puxar o destravamento
- (2) Pressionar o destravamento para baixo
- (3) Retirar o interruptor



Opção 2: Dispositivo de desconexão de alta voltagem alternativo

O dispositivo de desligamento de alta voltagem alternativo se encontra sob a cobertura da caixa de fusíveis no posto de comando no lado do motorista.

Este está identificado com uma plaqueta de informações.

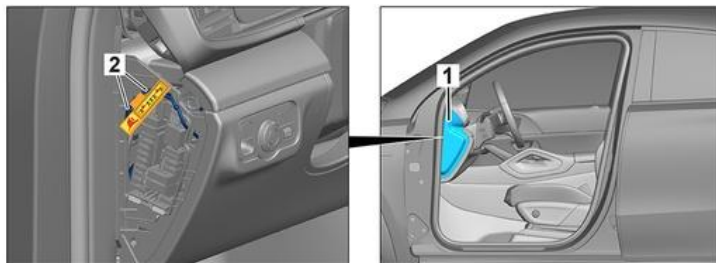

Remover a cobertura (1). Cortar o cabo no local assinalado (2).



Para garantir que na rede de alta tensão não haja tensão residual, esperar aprox. 20 segundos após o desligamento.



Os sistemas de segurança passivos, tais como airbags e pré-tensionadores dos cintos de segurança, continuam a ser alimentados com tensão pela rede de bordo de 12 V.



Desconectar a bateria de 12 V

1. Remover a cobertura da bateria de 12 V.
2. Soltar o cabo negativo da bateria de 12 V na união rosca e proteger contra contato não intencional.



Os sistemas de segurança passivos (airbags e pré-tensionadores dos cintos de segurança) são desativados.



4. Acesso aos ocupantes

Para a liberação dos ocupantes do veículo, devem ser levados em conta os componentes dos sistemas de retenção (principalmente elementos pirotécnicos) conforme as indicações na página 1.



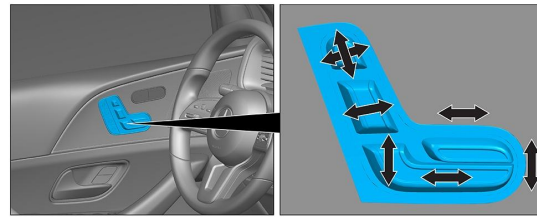

Ajuste da coluna de direção



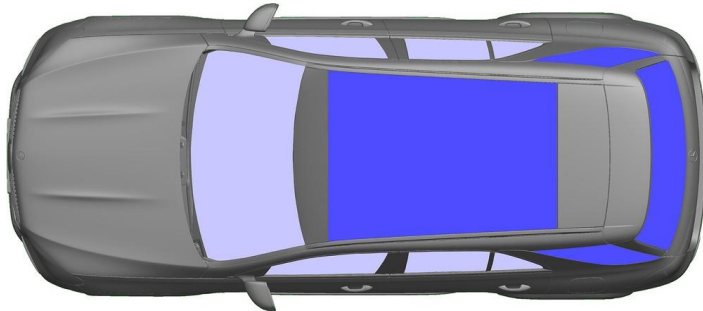

















Ajuste do banco (elétrico)



 VSG: vidro de segurança laminado

 ESG: vidro temperado

5. Armazenamento de energia / líquidos / gases / sólidos



	  	12 V
	     	400 V
	 	65 L
	  	700 ± 10 g

 Todos os cabos de alta tensão possuem um isolamento laranja.

6. Em caso de incêndio

 Usar grandes quantidades de água (H₂O) para extinguir um incêndio em um veículo.
Usar grandes quantidades de água (H₂O) para resfriar a bateria de íons de lítio.

 Advertência: nova ignição da bateria 

 Se o líquido de arrefecimento escorrer para fora da bateria de alta tensão, ela poderá ficar instável devido à sobrecarga térmica.
Verifique a temperatura da bateria com uma câmera infravermelha. 

7. Em caso de submersão

Não há risco de aplicação de tensão à carroceria.

Após a recuperação do veículo:

1. Deixar a água escoar para fora do compartimento interno do veículo.
2. Iniciar a desativação da rede de bordo de alta tensão (ver capítulo 3).



8. Reboque / transporte / estacionamento

Somente transportar o veículo com ambos os eixos em um reboque ou em um caminhão cegonheiro.

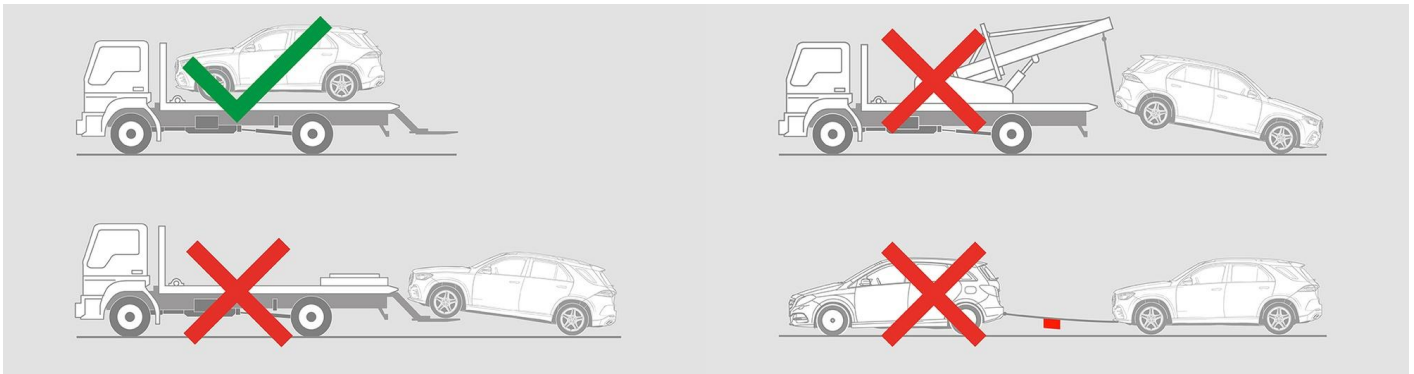

Manter a uma distância segura de outros veículos.

Advertência: nova ignição da bateria  

9. Informação adicional importante

Outras informações podem ser encontradas no ["Guia de serviços de reboque de carros"](#).

10. Explicação dos pictogramas usados



Veículo elétrico híbrido com combustíveis líquidos da classe 2



Perigo



Perigo de tensão



Inflamável



Prejudicial à saúde



Corrosivo



Toxicidade aguda



Explosivo



Extinguir com água



Usar câmera de infravermelho



Capô do motor



Remover a chave smart



Sistema de ar-condicionado



Perigo, baixa temperatura