







-  Airbag
-  Gerador de gás
-  Pré-tensionadores do cinto de segurança
-  Módulo de comando SRS
-  Mola de pressão a gás/mola pré-tensionada
-  Bateria de baixa voltagem
-  Reservatório de combustível diesel

Indicação: Para informações adicionais, favor consultar o nosso [guia de salvamento](#).



1. Identificação / reconhecimento

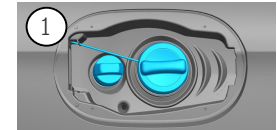

2. Imobilização / estabilização / levantamento

Freio de estacionamento

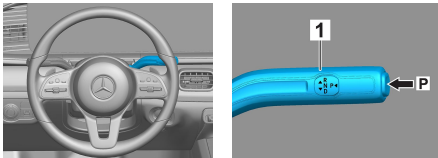

Freio de estacionamento

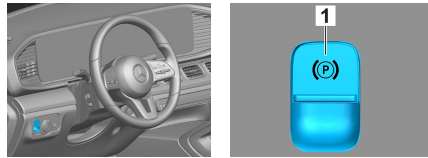

Pressionar o interruptor P na alavanca seletora (1).

Freio de estacionamento elétrico (1)

O freio de estacionamento é ativado automaticamente.

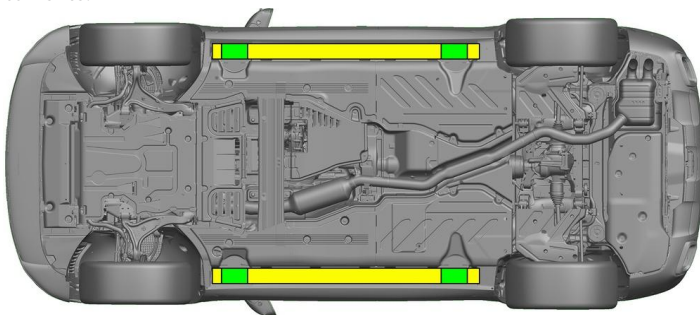

- Pontos de elevação adequados
- Pontos de estabilização adequados na lateral

Deve-se evitar uma deformação adicional das soleiras e do lado inferior do assoalho durante o resgate (por exemplo, por meio de suporte com equipamento hidráulico).

3. Neutralização dos principais perigos / regras de segurança

Desligar a ignição:

1. Pressionar a tecla START-STOP sem acionar o freio de serviço.
2. Manter a chave eletrônica do veículo em uma distância de pelo menos 5 m.

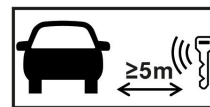

A ausência de ruídos do motor não significa que o veículo está desligado.

Uma nova partida é possível até que o veículo seja descomissionado.



### Desconectar a bateria de 12/48 V

1. Remover a cobertura da bateria de 12/48 V.
2. Soltar o cabo negativo da bateria de 12/48 V na união roscada e proteger contra contato não intencional.



Os sistemas de segurança passivos (airbags e pré-tensionadores dos cintos de segurança) são desativados.

### 4. Acesso aos ocupantes

Para a liberação dos ocupantes do veículo, devem ser levados em conta os componentes dos sistemas de retenção (principalmente elementos pirotécnicos) conforme as indicações na página 1.

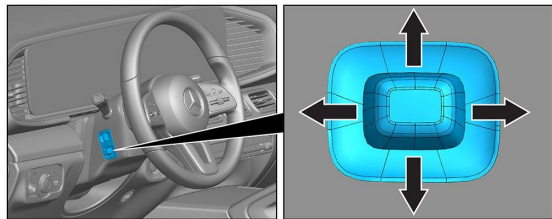

Ajuste da coluna de direção

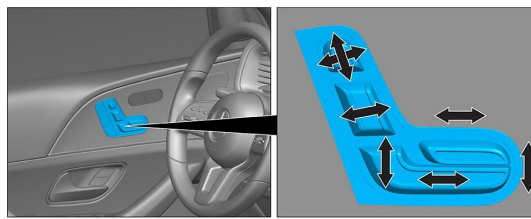

Ajuste do banco (elétrico)

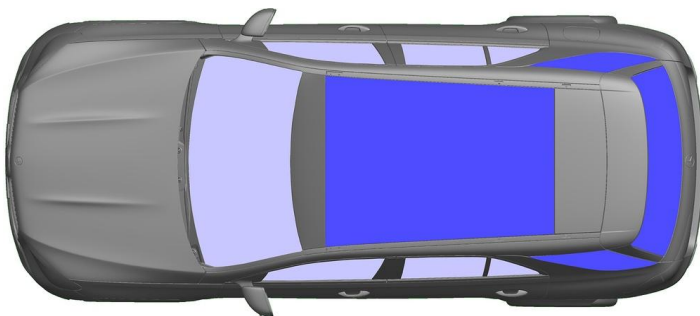

- VSG: vidro de segurança laminado
- ESG: vidro temperado

### 5. Armazenamento de energia / líquidos / gases / sólidos

		12 V/ 48 V
		85 L
		660 ± 10 g

### 6. Em caso de incêndio



Usar grandes quantidades de água (H<sub>2</sub>O) para extinguir um incêndio em um veículo.

### 7. Em caso de submersão

Não há risco de aplicação de tensão à carroceria. Após a recuperação do veículo:

1. Deixar a água escoar para fora do compartimento interno do veículo.
2. Iniciar a desativação da rede de bordo de 12 V/48 V (consulte o capítulo 3).



### 8. Reboque / transporte / estacionamento

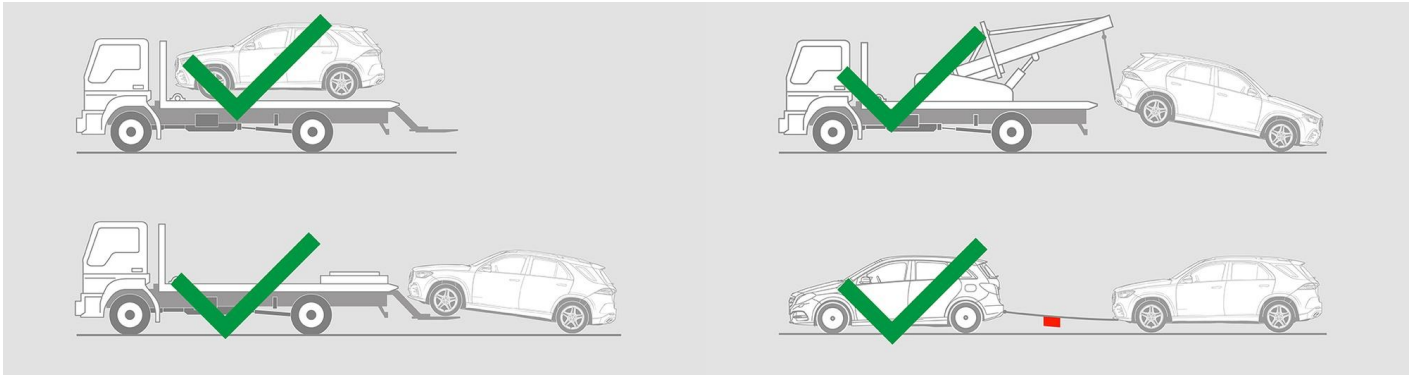

### 9. Informação adicional importante

Outras informações podem ser encontradas no "[Guia de serviços de reboque de carros](#)".

### 10. Explicação dos pictogramas usados



Veículo com combustíveis líquidos da classe 1



Perigo



Inflamável



Prejudicial à saúde



Corrosivo



Toxicidade aguda



Explosivo



Extinguir com água



Extinguir com espuma seca



Extinguir com espuma úmida



Remover a chave smart



Sistema de ar-condicionado



Perigo, baixa temperatura