









48V
Li-ion

12V
AGM

- | | | | | | | | | | |
|---|---|---|---------------------------|---|---|---|-----------------------|---|--|
|  | Airbag |  | Gerador de gás |  | Pré-tensionadores do cinto de segurança |  | Módulo de comando SRS |  | Sistema de proteção de pedestres ativo |
|  | Mola de pressão a gás/mola pré-tensionada |  | Bateria de baixa voltagem |  | Reservatório de combustível gasolina | | | | |

Indicação: Para informações adicionais, favor consultar o nosso [guia de salvamento](#).



1. Identificação / reconhecimento



2. Imobilização / estabilização / levantamento

Freio de estacionamento

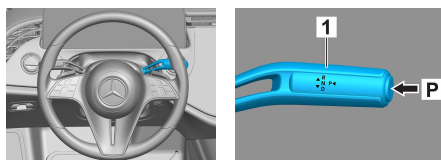

Freio de estacionamento

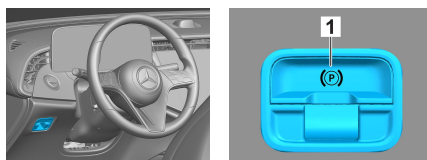

Pressionar o interruptor P na alavanca seletora (1).

O freio de estacionamento é ativado automaticamente.

Freio de estacionamento elétrico (1)

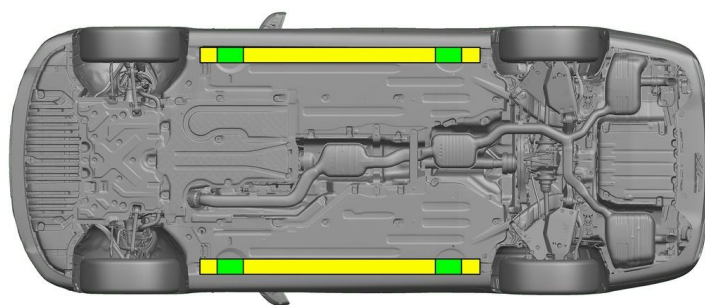

 Pontos de elevação adequados

 Pontos de estabilização adequados na lateral



Deve-se evitar uma deformação adicional das soleiras e do lado inferior do assoalho durante o resgate (por exemplo, por meio de suporte com equipamento hidráulico).

3. Neutralização dos principais perigos / regras de segurança

Desligar a ignição:

1. Pressionar a tecla START-STOP sem acionar o freio de serviço.
2. Manter a chave eletrônica do veículo em uma distância de pelo menos 5 m.

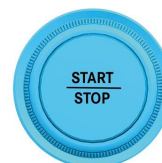
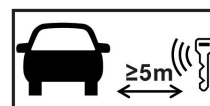

A ausência de ruídos do motor não significa que o veículo está desligado.



Uma nova partida é possível até que o veículo seja descomissionado.



Desconectar a bateria de 48 V

1. Remover a cobertura da bateria de 48 V no compartimento do motor.
2. Soltar o cabo negativo da bateria de 48 V na união roscada e proteger contra contato não intencional.





Desconectar a bateria de 12 V



1. Remover a cobertura da bateria de 12 V no porta-malas.
2. Soltar o cabo negativo da bateria de 12 V na união roscada e proteger contra contato não intencional.



Os sistemas de segurança passivos (airbags e pré-tensionadores dos cintos de segurança) são desativados.

4. Acesso aos ocupantes

Para a liberação dos ocupantes do veículo, devem ser levados em conta os componentes dos sistemas de retenção (principalmente elementos pirotécnicos) conforme as indicações na página 1.



Empurrar um objeto plano não metálico por cima, atrás da maçaneta da porta (1) retraída e alavancar levemente para fora.

Pegar por baixo, atrás da maçaneta da porta (1) e puxar para fora até a resistência e segurar.

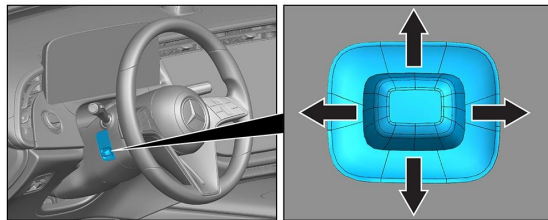



Ajuste da coluna de direção



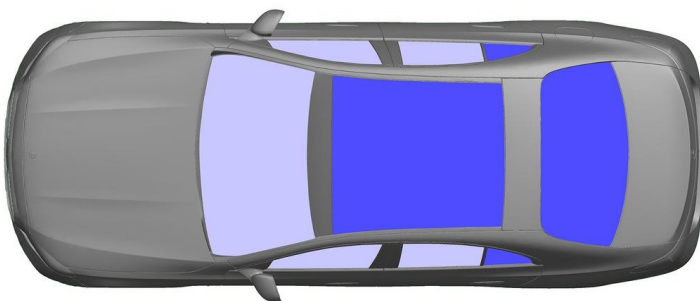











Ajuste do banco (elétrico)



 VSG: vidro de segurança laminado

 ESG: vidro temperado

5. Armazenamento de energia / líquidos / gases / sólidos

	    	12/48V
	 	66L
	  	600 ± 10g

6. Em caso de incêndio



Usar grandes quantidades de água (H₂O) para extinguir um incêndio em um veículo.



7. Em caso de submersão

Não há risco de aplicação de tensão à carroceria. Após a recuperação do veículo:

1. Deixar a água escoar para fora do compartimento interno do veículo.
2. Iniciar a desativação da rede de bordo de 12 V/48 V (consulte o capítulo 3).

8. Reboque / transporte / estacionamento



9. Informação adicional importante

Outras informações podem ser encontradas no "[Guia de serviços de reboque de carros](#)".

10. Explicação dos pictogramas usados

	Veículo com combustíveis líquidos da classe 2		Perigo		Inflamável		Prejudicial à saúde
	Corrosivo		Toxicidade aguda		Explosivo		Extinguir com água
	Extinguir com espuma seca		Extinguir com espuma úmida		Capô do motor		Porta-malas
	Remover a chave smart		Sistema de ar-condicionado		Perigo, baixa temperatura		