











- ① Bateria 12 V
- ② Bateria de alta voltagem
- ③ Tomada do veículo de alta voltagem
- ④ Carregador voltagem
- ⑤ Bateria adicional de 12 V

 Airbag	 Gerador de gás	 Pré-tensionadores do cinto de segurança	 Mola de pressão a gás	 Reservatório de combustível
 Módulo de comando dos sistemas de retenção	 Bateria 12 V	 Bateria de alta voltagem	 Componentes de alta voltagem	 Dispositivo de desligamento de alta voltagem
 Dispositivo de desligamento de alta voltagem alternativo				

Indicação: Para informações adicionais, favor consultar o nosso [guia de salvamento](#).



1. Identificação / reconhecimento

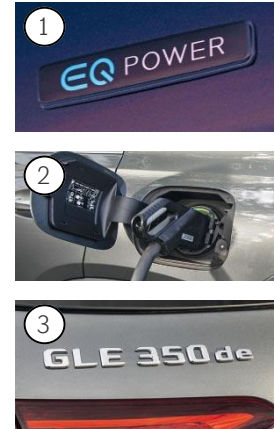
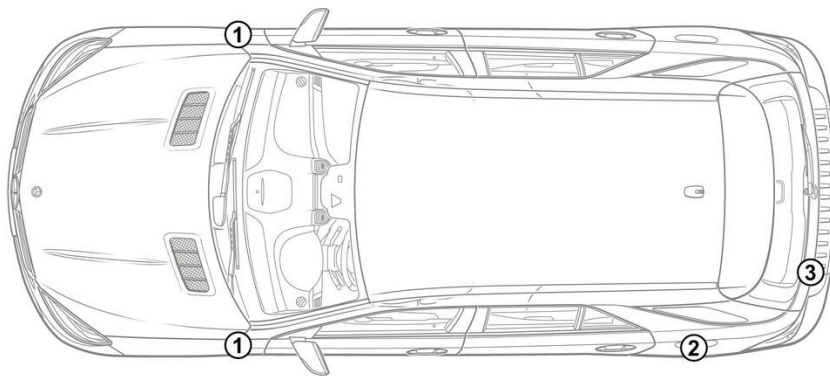

3. Neutralização dos principais perigos / regras de segurança

Desativação do sistema de alta voltagem

Em todos os outros casos, desativar a rede de bordo de alta voltagem da seguinte forma:

Opção 1: Dispositivo de desconexão de alta voltagem

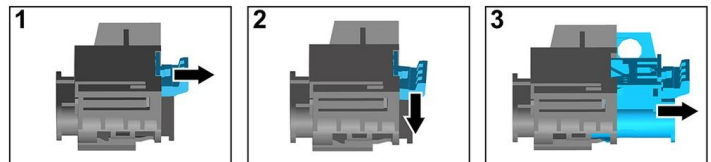
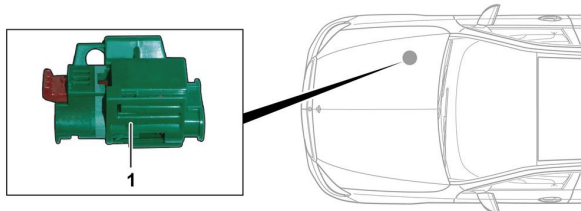

Die Hochvolt-Abschaltvorrichtung befindet sich im Motorraum auf der Beifahrerseite.



- (1) Puxar o destravamento
- (2) Pressionar o destravamento para baixo
- (3) Retirar o interruptor



Opção 2: Dispositivo de desconexão de alta voltagem alternativo

O dispositivo de desligamento de alta voltagem alternativo se encontra sob a cobertura da caixa de fusíveis no posto de comando no lado do motorista.

Este está identificado com uma plaqueta de informações.

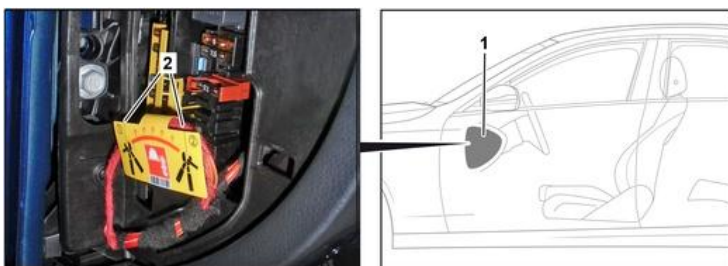

Remover a cobertura (1). Cortar o cabo no local assinalado (2).



Desconectar a bateria de 12 V

- 1. Remover a cobertura da bateria de 12 V.
- 2. Soltar o cabo negativo da bateria de 12 V na união rosca e proteger contra contato não intencional.

