













- ① Bateria principal de 12 V
- ② Bateria adicional de 12 V
- ③ Bateria de alta voltagem
- ④ Tomada do veículo de alta voltagem
- ⑤ Dispositivo de desligamento de alta voltagem
- ⑥ Dispositivo de desligamento de alta voltagem alternativo

|  |   |   |   |  |
|--|---|---|---|--|
|  Airbag  |  Gerador de gás        |  Pré-tensionadores do cinto de segurança |  Mola de pressão a gás        |  Reservatório de combustível                  |
|  Módulo de comando dos sistemas de retenção               |  Bateria 12 V          |  Bateria de alta voltagem                |  Componentes de alta voltagem |  Dispositivo de desligamento de alta voltagem |
|  Dispositivo de desligamento de alta voltagem alternativo |  Proteção de pedestres |   |   |  |

Indicação: Para informações adicionais, favor consultar o nosso [guia de salvamento](#).



## 1. Identificação / reconhecimento

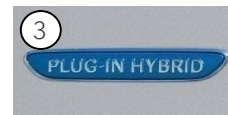
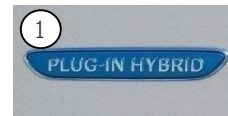
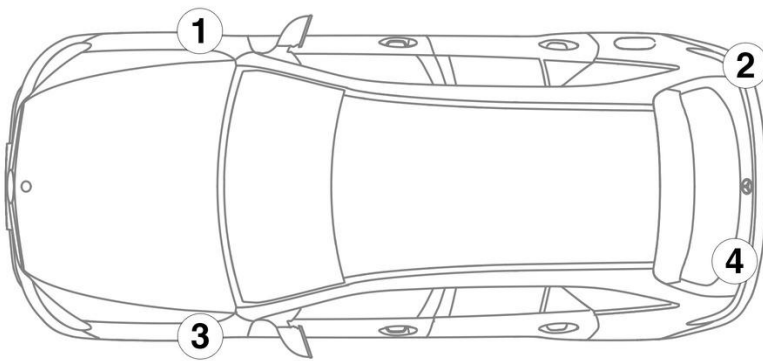

## 3. Neutralização dos principais perigos / regras de segurança

### Desativação do sistema de alta voltagem

Em todos os outros casos, desativar a rede de bordo de alta voltagem da seguinte forma:

#### Opção 1: Dispositivo de desconexão de alta voltagem

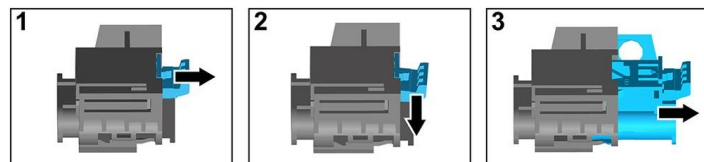
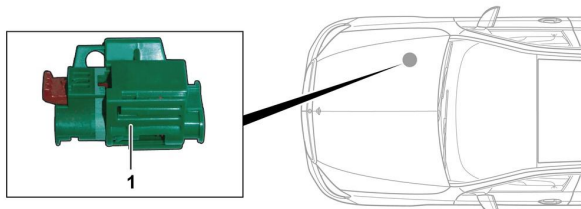

Die Hochvolt-Abschaltvorrichtung befindet sich im Motorraum auf der Beifahrerseite.



- (1) Puxar o destravamento
- (2) Pressionar o destravamento para baixo
- (3) Retirar o interruptor



#### Opção 2: Dispositivo de desconexão de alta voltagem alternativo

O dispositivo de desligamento de alta voltagem alternativo se encontra sob a cobertura da caixa de fusíveis no posto de comando no lado do motorista.

Este está identificado com uma plaqueta de informações.

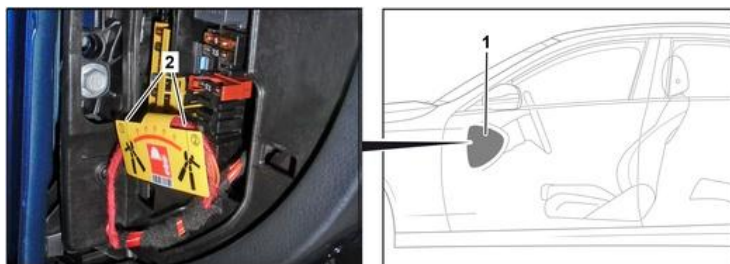

Remover a cobertura (1). Cortar o cabo no local assinalado (2).



#### Desconectar a bateria de 12 V

1. Remover a cobertura da bateria de 12 V.
2. Soltar o cabo negativo da bateria de 12 V na união rosca e proteger contra contato não intencional.

