









- | | | | | | | | | | |
|---|--|---|------------------------------|---|------------------------------|---|-------------------------|---|---------------------------------|
|  | Poduszka powietrzna |  | Generator gazu |  | Napinacz pasa bezpieczeństwa |  | Jednostka sterująca SRS |  | Aktywny system ochrony pieszych |
|  | Amortyzator ciśnienia gazu / Wstępnie naprężona sprężyna |  | Akumulator niskiego napięcia |  | Diesel zbiornik paliwa | | | | |

Wskazówka: Więcej informacji znajduje się w naszych [wytocznych ratowniczych](#).



1. Identyfikacja / rozpoznanie

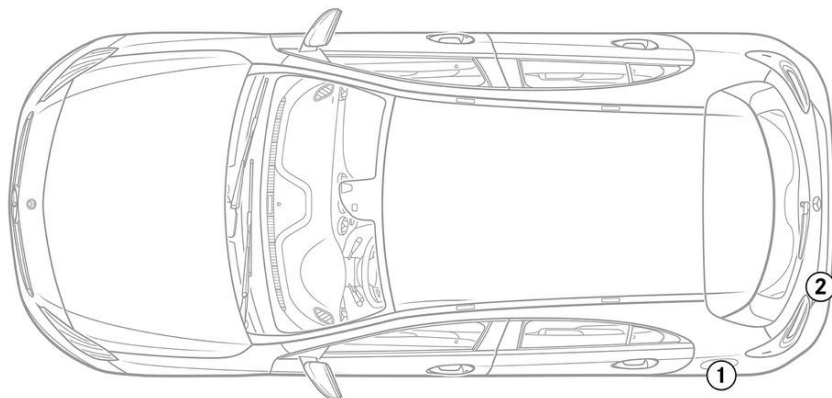

2

A180d