







① kierownica po lewej stronie    ② kierownica po prawej stronie

- |  |                              |   |                         |   |                              |   |  |   |                           |
|--|------------------------------|---|-------------------------|---|------------------------------|---|--|---|---------------------------|
|  | Poduszka powietrzna          |  | Generator gazu          |  | Napinacz pasa bezpieczeństwa |  | Amortyzator ciśnienia gazu / Wstępnie naprężona sprężyna |  | Wzmocnienie konstrukcyjne |
|  | Akumulator niskiego napięcia |  | Benzyna zbiornik paliwa |   |                              |   |  |   |                           |

Wskazówka: Więcej informacji znajduje się w naszych [wytucznych ratowniczych](#).



1. Identyfikacja / rozpoznanie

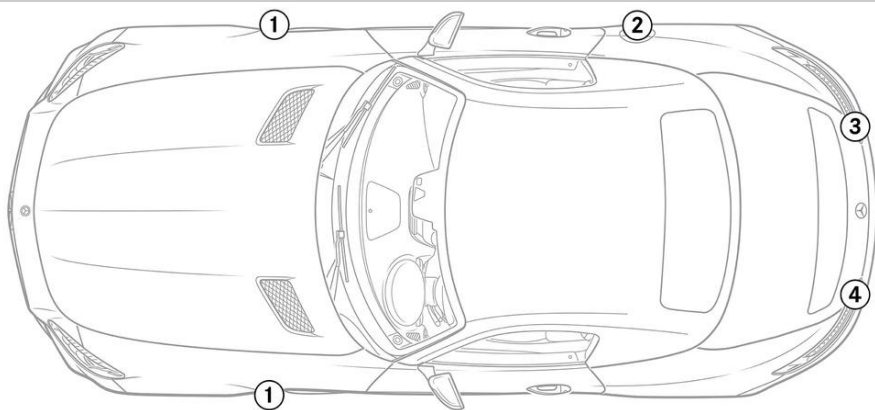

1

**V8 BITURBO**

2

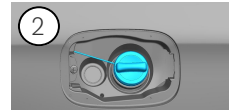

3

**GT**

4

