







① kierownica po lewej stronie ② kierownica po prawej stronie

- | | | | | | | | | | |
|---|------------------------------|---|-------------------------|---|------------------------------|---|-------------------------|---|--|
|  | Poduszka powietrzna |  | Generator gazu |  | Napinacz pasa bezpieczeństwa |  | Jednostka sterująca SRS |  | Amortyzator ciśnienia gazu / Wstępnie naprężona sprężyna |
|  | Akumulator niskiego napięcia |  | Benzyna zbiornik paliwa | | | | | | |

Wskazówka: Więcej informacji znajduje się w naszych [wytucznych ratowniczych](#).



1. Identyfikacja / rozpoznanie

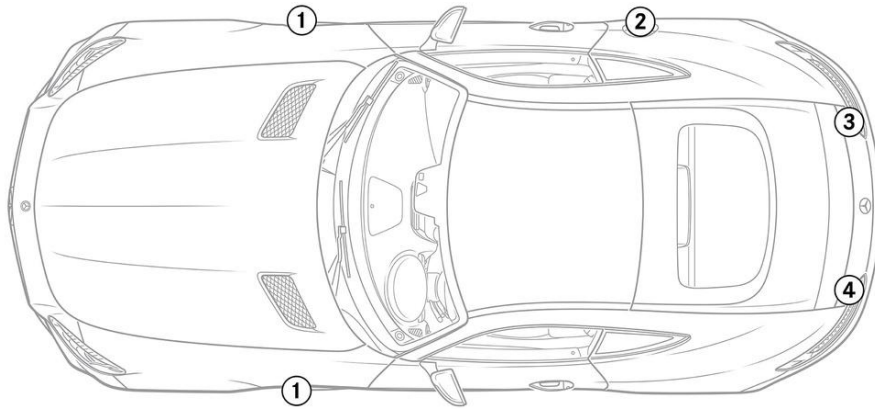

1

V8 BITURBO

2

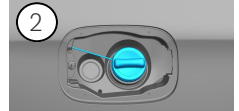

3

GT

4

