









- | | | | | |
|--|--|---|--|--|
|  Airbag |  Gasgenerator |  Gordelspanner |  SRS regeleenheid |  Actief voetgangersbeschermingsysteem |
|  Gasdrukdemper / voorgespannen veer |  Laagspannings-accu |  Diesel brandstof-tank | | |

Let op: Meer informatie vindt u in onze [Leidraad voor hulpdiensten](#).



1. Identificatie / herkenning

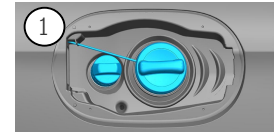

2. Immobilisatie / stabilisatie / heffen

Parkeerrem

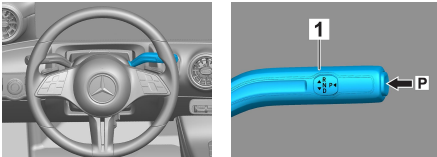

Schakelaar P aan de keuzehendel (1) indrukken. De parkeerrem wordt automatisch geactiveerd.

Parkeerrem

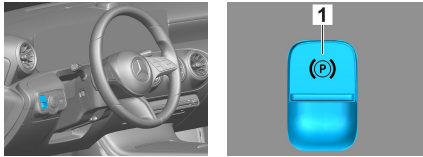

Elektrische parkeerrem (1)

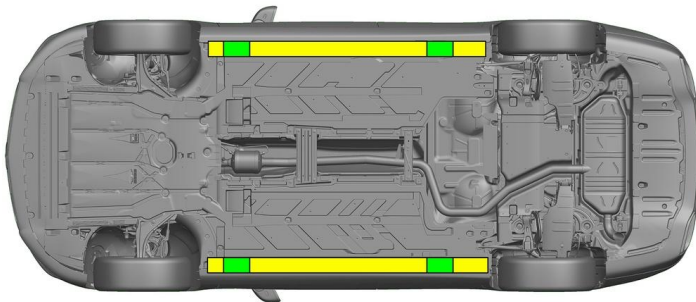

- Geschikte krikpunten
- Geschikte stabilisatiepunten aan de zijkant

Extra vervorming van de dorpels en de vloer tijdens de redding (bijv. door ondersteuning met hydraulische apparatuur) moet worden vermeden.

3. Directe gevaren uitschakelen / veiligheidsvoorschriften

Contact uitschakelen:

1. START-STOP-knop indrukken zonder de bedrijfsrem te bedienen.
2. Elektronische sleutel van het voertuig op afstand van minstens 5 m bewaren.

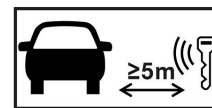

De afwezigheid van motorgeluiden betekent niet dat het voertuig is uitgeschakeld.

Een herstart is mogelijk tot het voertuig buiten gebruik wordt gesteld.



12V-accu afklemmen

1. Afdekking van de 12V-accu in de motorruimte verwijderen.
2. Minuskabel van de 12V-accu aan de schroefverbinding losmaken en deze beveiligen tegen onbedoeld contact.



De passieve veiligheidssystemen (airbags en gordelspanners) worden gedeactiveerd.

4. Toegang tot de inzittenden

Bij het bevrijden van de inzittenden moet rekening worden gehouden met de componenten van het veiligheidssysteem (in het bijzonder pyrotechnische elementen) conform de informatie op pagina 1.

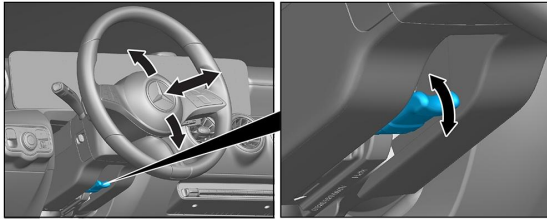

Stuurverstelling

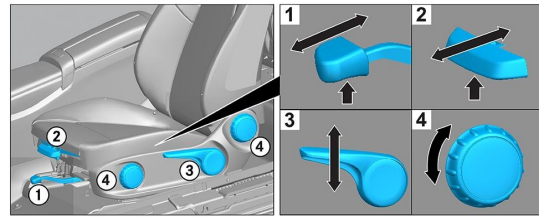

Stoelverstelling (mechanisch)

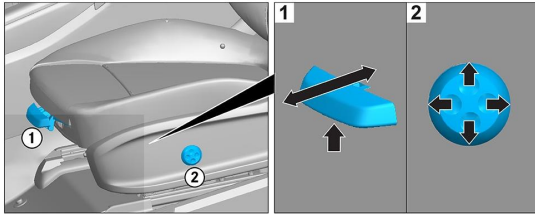

Stoelverstelling (elektrisch)

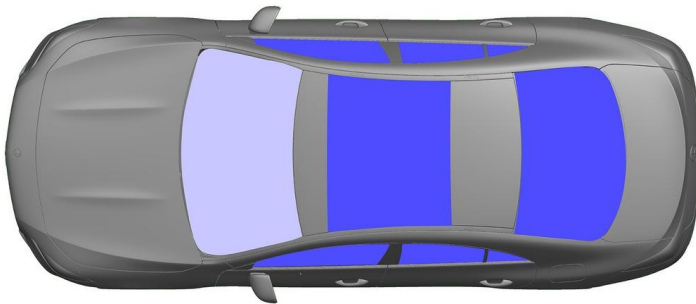

VSG: Gelaagd veiligheidsglas
 ESG: Enkelvoudig veiligheidsglas

5. Opgeslagen energie / vloeistoffen / gassen / vaste stoffen

		12V
		43L
		530 ± 10g

6. In geval van brand



Voor het blussen van een voertuigbrand grote hoeveelheden water (H₂O) gebruiken.

7. In geval van onderdompeling

Er is geen gevaar dat er spanning op de carrosserie staat. Na de berging van het voertuig:

1. Het water uit het interieur laten lopen.
2. Deactiveren van het 12V/48V-boordnet starten (zie hoofdstuk 3).



8. Slepen / transport / opslag

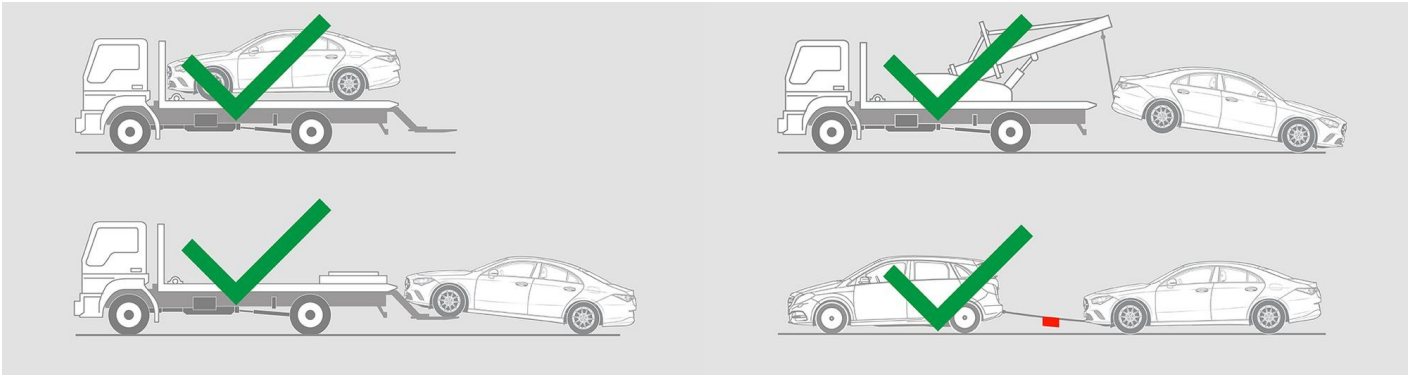

9. Belangrijke bijkomende informatie

Meer informatie vindt u in de [Leidraad voor sleepdiensten personenauto](#).

10. Verklaring van gebruikte pictogrammen

- | | | | |
|---|--|--|---|
|  Voertuig op brandstof van vloeistofgroep 1 |  Algemeen waarschuwingsbord |  Ontvlambaar |  Gevaarlijk voor de menselijke gezondheid |
|  Corrosief |  Explosief |  Gebruik water om het vuur te blussen |  Gebruik droog schuim om het vuur te blussen |
|  Gebruik nat schuim om het vuur te blussen |  Kap |  Slimme sleutel verwijderen |  Airco-component |
|  Waarschuwing: lage temperatuur | | | |