

- | | | | | | | | | | |
|---|------------------------------------|---|-------------------|---|--|---|--------------------|---|---------------------------------------|
|  | Airbag |  | Gasgenerator |  | Gordelspanner |  | SRS regeleenheid |  | Actief voetgangersbeschermingssysteem |
|  | Gasdrukdemper / voorgespannen veer |  | Laagspanningsaccu |  | Benzine brandstoftank |  | Accu, hoogspanning |  | Hoogspanningskabel |
|  | Hoogspanningscomponent |  | Kabelbreuk |  | Laagspanningsapparaat dat de hoogspanning loskoppelt | | | | |

Let op: Meer informatie vindt u in onze [Leidraad voor hulpdiensten](#).

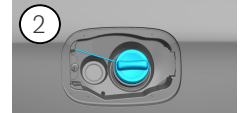

1. Identificatie / herkenning

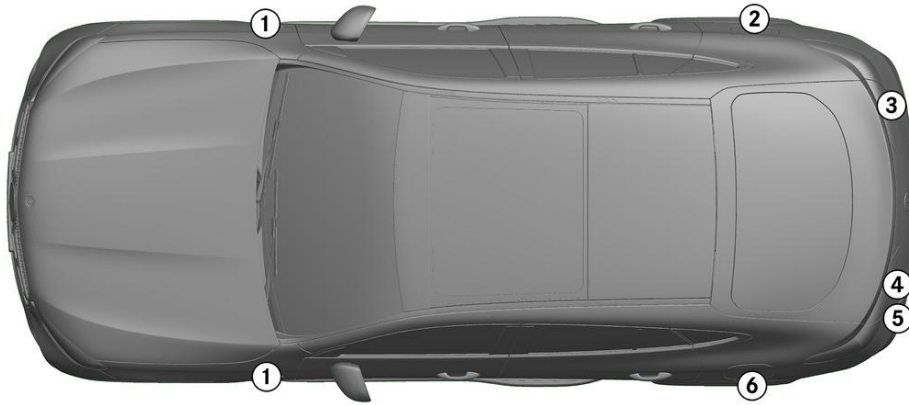

2. Immobilisatie / stabilisatie / heffen

Parkeerrem

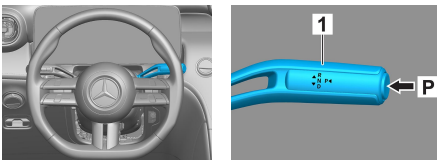

Parkeerrem

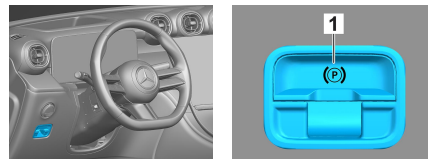

Schakelaar P aan de keuzehendel (1) indrukken. De parkeerrem wordt automatisch geactiveerd.

Elektrische parkeerrem (1)

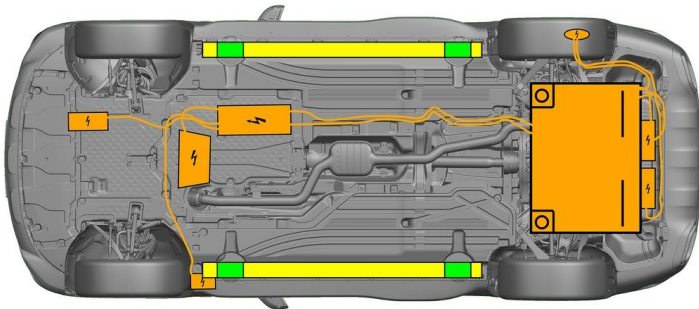

- Geschikte krikpunten
- Geschikte stabilisatiepunten aan de zijkant
- Hoogspanningsaccu



Extra vervorming van de dorpels en de vloer tijdens de redding (bijv. door ondersteuning met hydraulische apparatuur) moet worden vermeden.

3. Directe gevaren uitschakelen / veiligheidsvoorschriften

Contact uitschakelen:

1. START-STOP-knop indrukken zonder de bedrijfsrem te bedienen.
2. Elektronische sleutel van het voertuig op afstand van minstens 5 m bewaren.



De afwezigheid van motorgeluiden betekent niet dat het voertuig is uitgeschakeld.



Een herstart is mogelijk tot het voertuig buiten gebruik wordt gesteld.

Deactiveren van het hoogspanningssysteem



Bij ongevallen waarbij airbags en gordelspanners worden geactiveerd, wordt het hoogspanningssysteem automatisch uitgeschakeld.





In alle andere gevallen moet het hoogspanningssysteem als volgt worden gedeactiveerd:

Optie 1: Uitschakelinrichting voor de hoogspanning

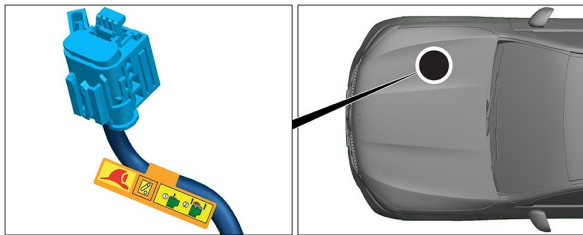

De uitschakelinrichting voor de hoogspanning bevindt zich in de motorruimte aan de passagierszijde.



- (1) Aan ontgrendeling trekken
- (2) Ontgrendeling omlaag duwen
- (3) Schakelaar eruit trekken



Optie 2: Alternatieve uitschakelinrichting voor de hoogspanning



De alternatieve uitschakelinrichting voor de hoogspanning bevindt zich onder de afdekking van de zekeringkast aan de cockpit aan de bestuurderskant.

Ze is gemarkeerd met een aanwijzingsplaatje.

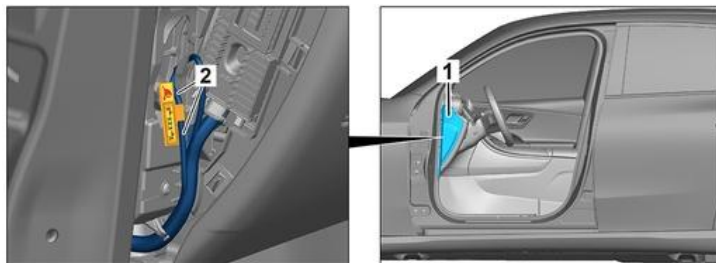

Afdekking (1) verwijderen. Kabel aan het gemarkeerde punt (2) doorknippen.



Na het uitschakelen ca. 20 seconden wachten om er zeker van te zijn dat er geen restspanning in het hoogspanningsnet aanwezig is.



De passieve veiligheidssystemen, zoals airbags en gordelspanners, worden nog steeds van spanning voorzien door het 12V-boordnet.



12V-accu afklemmen



1. Afdekking van de 12V-accu in de motorruimte verwijderen.
2. Minuskabel van de 12V-accu aan de schroefverbinding losmaken en deze beveiligen tegen onbedoeld contact.



De passieve veiligheidssystemen (airbags en gordelspanners) worden gedeactiveerd.



4. Toegang tot de inzittenden

Bij het bevrijden van de inzittenden moet rekening worden gehouden met de componenten van het veiligheidssysteem (in het bijzonder pyrotechnische elementen) conform de informatie op pagina 1.

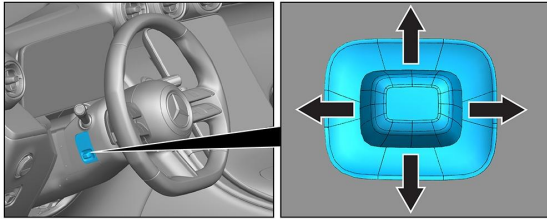

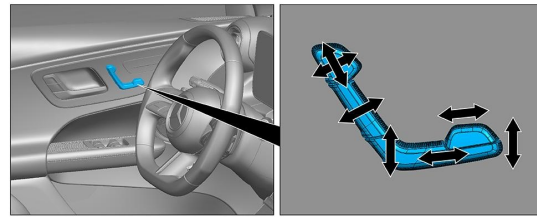

Stuurverstelling



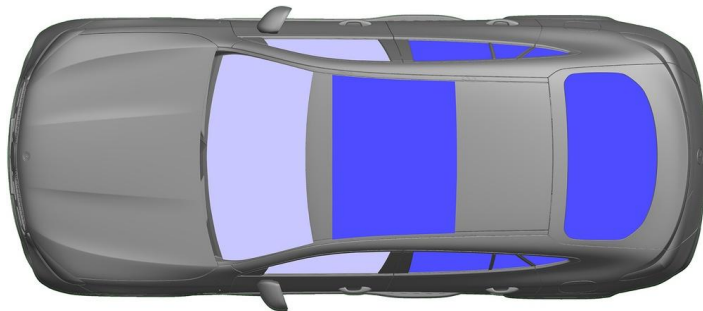

















Stoelverstelling (elektrisch)



 VSG: Gelaagd veiligheidsglas
 ESG: Enkelvoudig veiligheidsglas

5. Opgeslagen energie / vloeistoffen / gassen / vaste stoffen

	  	12V
	     	400V
	 	62L
	  	660 ± 10g

 Alle hoogspanningskabels zijn voorzien van een oranjekeurige isolatie.

6. In geval van brand



Voor het blussen van een voertuigbrand grote hoeveelheden water (H₂O) gebruiken.
Voor het koelen van de li-ion-accu grote hoeveelheden water (H₂O) gebruiken.



Waarschuwing: Opnieuw ontsteken van de accu



Als koelvloeistof uit de hoogspanningsaccu lekt, kan deze instabiel worden als gevolg van thermische overbelasting. Controleer de accutemperatuur met een infrarood-warmtebeeldcamera.



7. In geval van onderdompeling

Er is geen gevaar dat er spanning op de carrosserie staat.

Na de berging van het voertuig:

1. Het water uit het interieur laten lopen.
2. Deactiveren van het hoogspanningssysteem starten (zie hoofdstuk 3).



8. Slepen / transport / opslag

Het voertuig alleen met beide assen op een takelwagen of autotransporter transporteren.

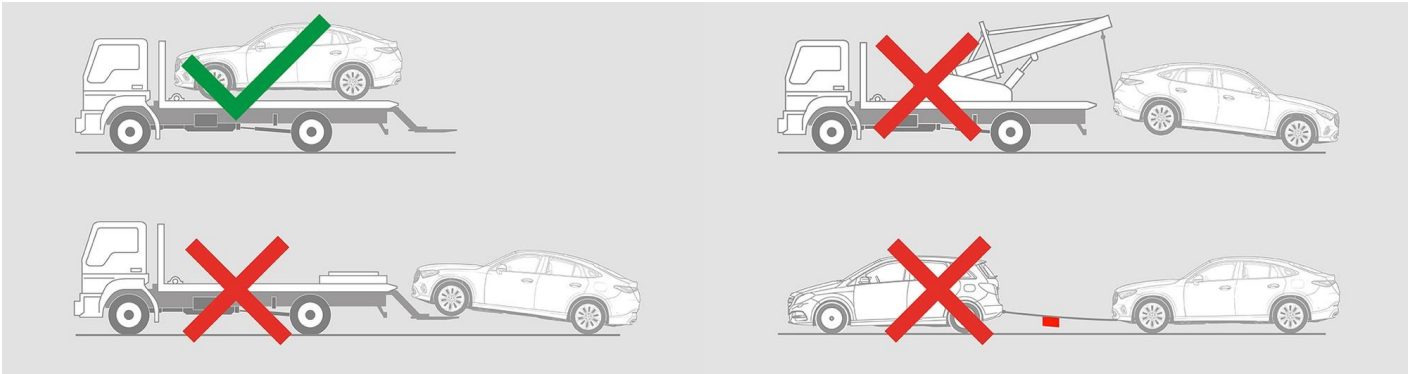















Op veilige afstand van andere voertuigen stallen.

 **Waarschuwing: Opnieuw ontsteken van de accu** 

9. Belangrijke bijkomende informatie

Meer informatie vindt u in de [Leidraad voor sleepdiensten personenauto](#).

10. Verklaring van gebruikte pictogrammen

- | | | | | | | | |
|---|---|---|------------------------------------|---|-----------------------------|---|----------------------------|
|  | Hybride elektrisch voertuig op brandstof van vloeistofgroep 2 |  | Algemeen waarschuwingsbord |  | Waarschuwing, elektriciteit |  | Ontvlambaar |
|  | Gevaarlijk voor de menselijke gezondheid |  | Corrosief |  | Acute toxiciteit |  | Explosief |
|  | Gebruik water om het vuur te blussen |  | Gebruik thermische infraroodcamera |  | Kap |  | Slimme sleutel verwijderen |
|  | Airco-component |  | Waarschuwing; lage temperatuur | | | | |