

-  Airbag
-  Gasgenerator
-  Gordelspanner
-  SRS regeleenheid
-  Actief voetgangersbeschermingsysteem
-  Gasdrukdemper / voorgespannen veer
-  Laagspanningsaccu
-  Benzine brandstoftank

Let op: Meer informatie vindt u in onze [Leidraad voor hulpdiensten](#).

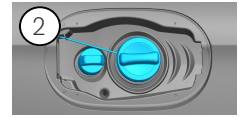

1. Identificatie / herkenning

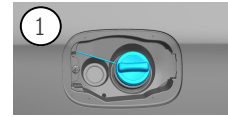

2. Immobilisatie / stabilisatie / heffen

Parkeerrem

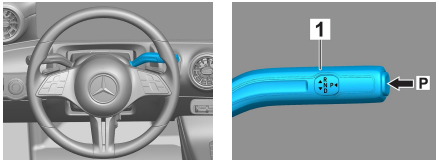

Parkeerrem



Schakelaar P aan de keuzehendel (1) indrukken. De parkeerrem wordt automatisch geactiveerd.

Elektrische parkeerrem (1)

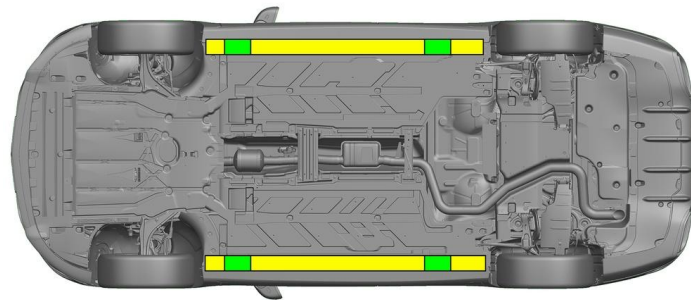

Geschikte krikpunten



Geschikte stabilisatiepunten aan de zijkant



Extra vervorming van de dorpels en de vloer tijdens de redding (bijv. door ondersteuning met hydraulische apparatuur) moet worden vermeden.

3. Directe gevaren uitschakelen / veiligheidsvoorschriften

Contact uitschakelen:

1. START-STOP-knop indrukken zonder de bedrijfsrem te bedienen.
2. Elektronische sleutel van het voertuig op afstand van minstens 5 m bewaren.

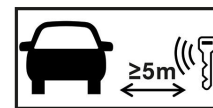

De afwezigheid van motorgeluiden betekent niet dat het voertuig is uitgeschakeld.



Een herstart is mogelijk tot het voertuig buiten gebruik wordt gesteld.



12V-accu afklemmen

1. Afdekking van de 12V-accu in de motorruimte verwijderen.
2. Minuskabel van de 12V-accu aan de schroefverbinding losmaken en deze beveiligen tegen onbedoeld contact.



De passieve veiligheidssystemen (airbags en gordelspanners) worden gedeactiveerd.



4. Toegang tot de inzittenden

Bij het bevrijden van de inzittenden moet rekening worden gehouden met de componenten van het veiligheidssysteem (in het bijzonder pyrotechnische elementen) conform de informatie op pagina 1.



Stuurverstelling





Stoelverstelling (mechanisch)

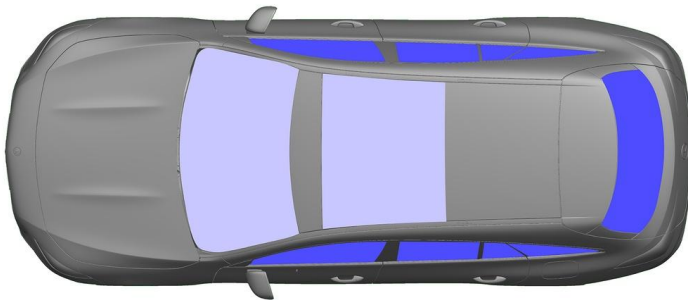

Stoelverstelling (elektrisch)



 VSG: Gelaagd veiligheidsglas

 ESG: Enkelvoudig veiligheidsglas

5. Opgeslagen energie / vloeistoffen / gassen / vaste stoffen



6. In geval van brand



Voor het blussen van een voertuigbrand grote hoeveelheden water (H₂O) gebruiken.

7. In geval van onderdompeling

Er is geen gevaar dat er spanning op de carrosserie staat. Na de berging van het voertuig:

1. Het water uit het interieur laten lopen.
2. Deactiveren van het 12V/48V-boordnet starten (zie hoofdstuk 3).

8. Slepen / transport / opslag

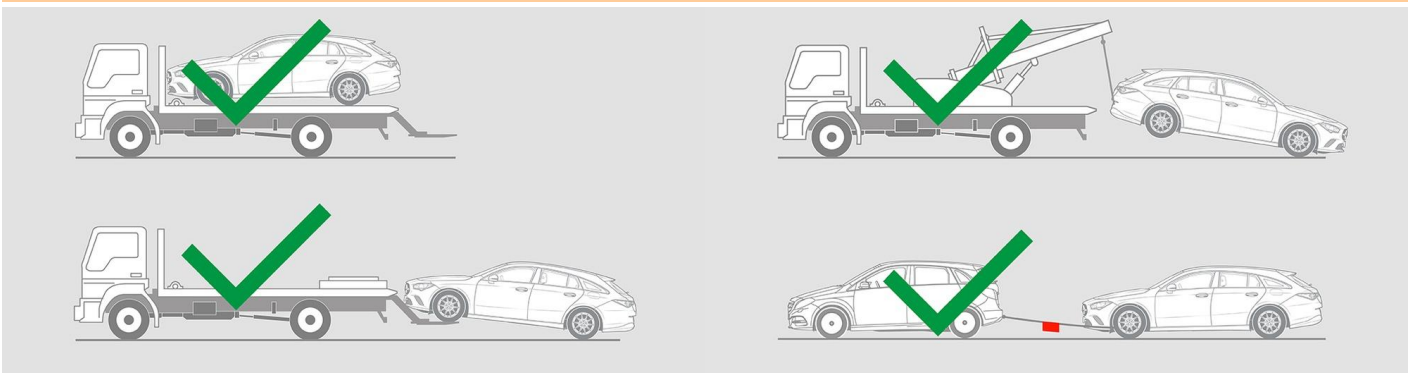



9. Belangrijke bijkomende informatie

Meer informatie vindt u in de [Leidraad voor sleepdiensten personenauto](#).

10. Verklaring van gebruikte pictogrammen



Voertuig op brandstof van vloeistofgroep 1



Voertuig op brandstof van vloeistofgroep 2



Algemeen waarschuwingsbord



Ontvlambaar



Gevaarlijk voor de menselijke gezondheid



Corrosief



Acute toxiciteit



Gebruik water om het vuur te blussen



Gebruik droog schuim om het vuur te blussen



Gebruik nat schuim om het vuur te blussen



Kap



Slimme sleutel verwijderen