











-  Airbag
-  Gasgenerator
-  Gordelspanner
-  SRS regeleenheid
-  Gasdrukdemper / voorgespannen veer
-  Laagspannings-accu
-  Accu, hoogspanning
-  Hoogspanningskabel
-  Hoogspanningscomponent
-  Kabelbreuk
-  Laagspanningsapparaat dat de hoogspanning loskoppelt

Let op: Meer informatie vindt u in onze [Leidraad voor hulpdiensten](#).



1. Identificatie / herkenning

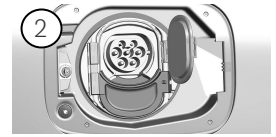
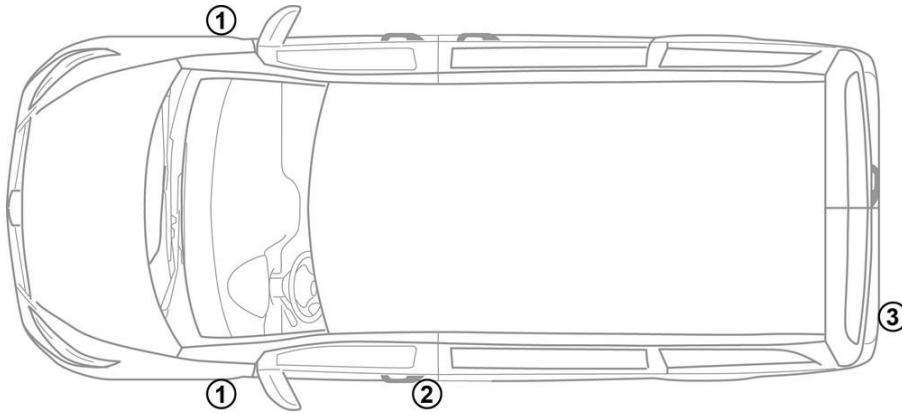

3. Directe gevaren uitschakelen / veiligheidsvoorschriften

Deactiveren van het hoogspanningssysteem

In alle andere gevallen moet het hoogspanningssysteem als volgt worden gedeactiveerd:

Optie 1: Uitschakelinrichting voor de hoogspanning

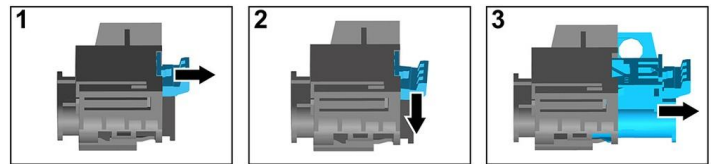
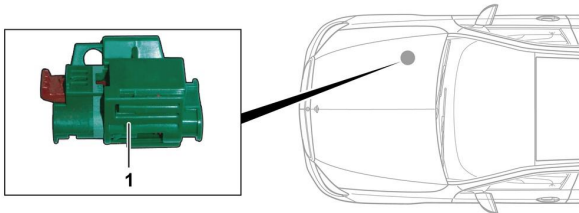

De uitschakelinrichting voor de hoogspanning bevindt zich in de motorruimte aan de passagierszijde.



- (1) Aan ontgrendeling trekken
- (2) Ontgrendeling omlaag duwen
- (3) Schakelaar eruit trekken

Optie 2: Alternatieve uitschakelinrichting voor de hoogspanning

De alternatieve uitschakelinrichting voor de hoogspanning bevindt zich in de stoelkast van de rechter voorstoel. Ze is gemarkeerd met een aanwijzingsplaatje.

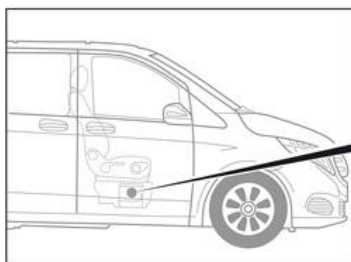

Afdekking (1) verwijderen. Kabel aan het gemarkeerde punt (2) doorknippen.



12V-accu afklemmen

- 1. Afdekking van de 12V-accu verwijderen.
- 2. Minuskabel van de 12V-accu aan de schroefverbinding losmaken en deze beveiligen tegen onbedoeld contact.