









- ① Batterie 12 V, Linkslenker ② Batterie 12 V, Rechtslenker ③ Hochvolt-Batterie ④ Hochvolt-Abschaltvorrichtung
- ⑤ HV-Ladesteckdose

Legende

- | | | | |
|--|---|---|---|
|  Airbag |  Gasgenerator |  Gurtstraffer |  Karosserieverstärkung |
|  Steuergerät Rückhaltesysteme |  Batterie 12 V |  Hochvolt-Batterie |  Hochvolt-Komponenten |
|  Hochvoltabschaltvorrichtung | | | |

Hinweis

Weiterführende Informationen entnehmen Sie bitte unserem [Rettungsleitfaden](#).



Fahrzeugidentifizierung

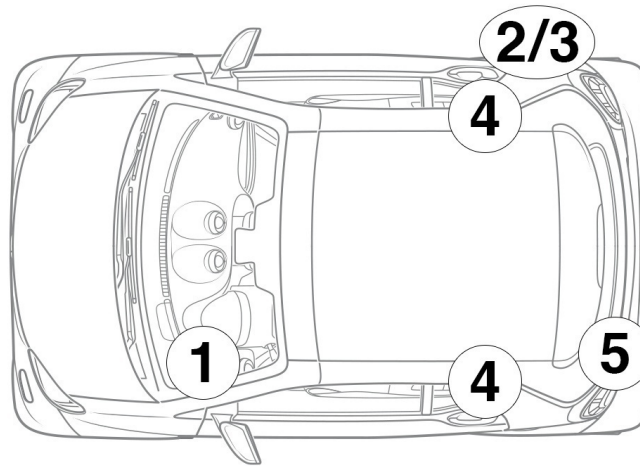

- ① Anzeige Ladezustand/ Energiefluss Hochvolt-Batterie



- ② HV-Ladesteckdose ECE



- ③ HV-Ladesteckdose USA/Kanada



- ④ B-Säule links /rechts



- ⑤ Heckklappe links



Hochvoltabschaltvorrichtung

Die Hochvoltabschaltvorrichtung befindet sich an der Unterseite der Hochvolt-Batterie in Fahrtrichtung rechts hinten.

Hinweis

Vor Betätigen der Hochvoltabschaltvorrichtung Zündung ausschalten.

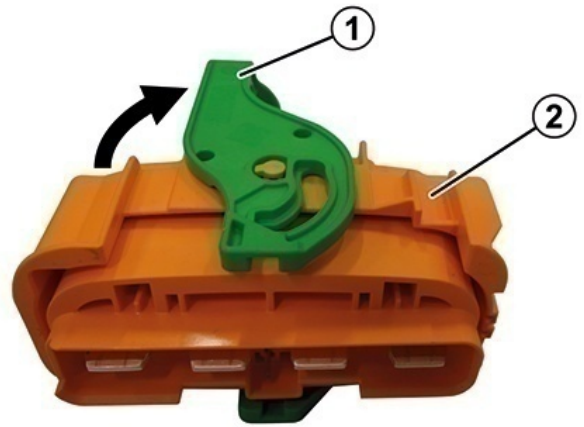
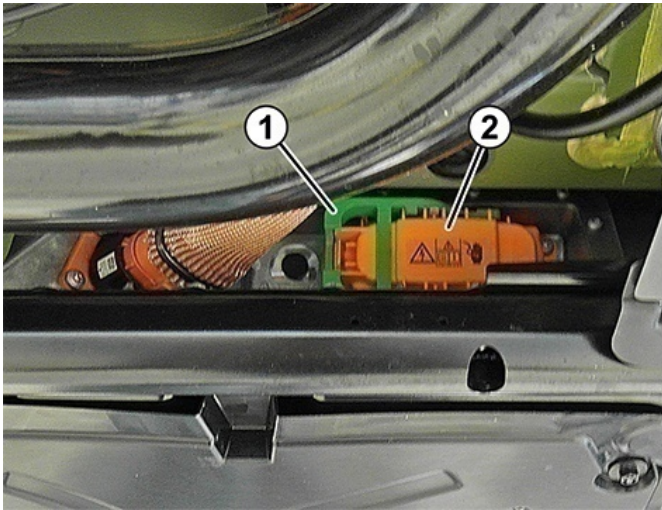

Verriegelung (1) am Stecker (2) öffnen / Stecker (2) aus der Hochvolt-Batterie herausziehen