







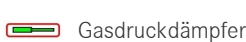

- ① Batterie 12 V, Linkslenker
- ② Batterie 12 V, Rechtslenker
- ③ Hochvolt-Batterie
- ④ Hochvolt-Abschaltvorrichtung
- ⑤ HV-Ladesteckdose

## Legende

- |   |   |   |  |
|---|---|---|--|
|  Airbag                       |  Gasgenerator  |  Gurtstraffer      |  Gasdruckdämpfer      |
|  Steuergerät Rückhaltesysteme |  Batterie 12 V |  Hochvolt-Batterie |  Hochvolt-Komponenten |
|  Hochvoltabschaltvorrichtung  |   |   |  |

## Hinweis

Weiterführende Informationen entnehmen Sie bitte unserem [Rettungsleitfaden](#).



## Fahrzeugidentifizierung

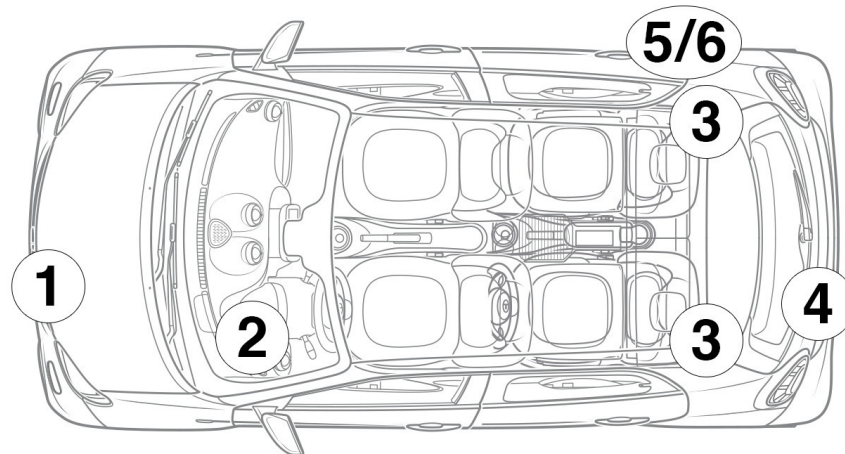

① Frontklappe links



② Anzeige Ladezustand/ Energiefluss Hochvoltbatterie



③ B-Säule links /rechts



④ Heckklappe links



⑤ HV-Ladesteckdose ECE



⑥ HV-Ladesteckdose USA/Kanada



## Hochvoltabschaltvorrichtung

Die Hochvoltabschaltvorrichtung befindet sich an der Unterseite der Hochvoltbatterie in Fahrtrichtung rechts hinten

### Hinweis

Vor Betätigen der Hochvoltabschaltvorrichtung Zündung ausschalten.

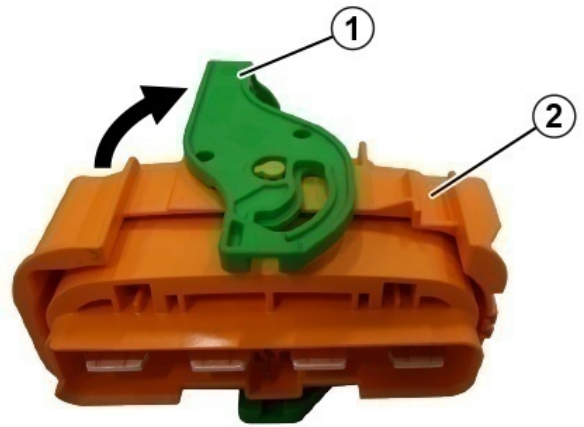
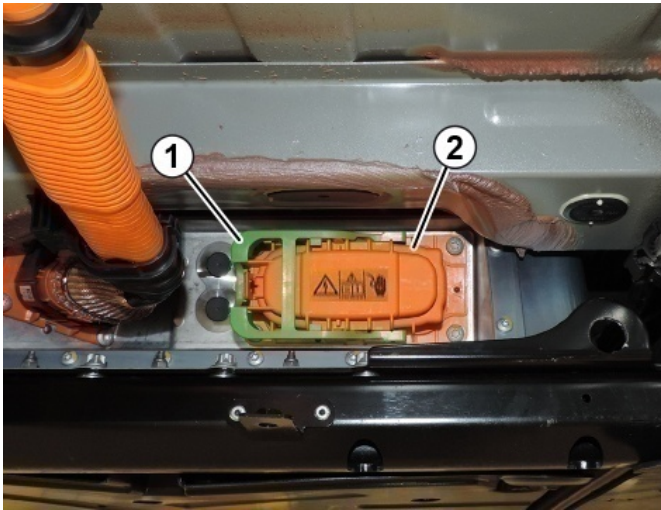

Verriegelung (1) am Stecker (2) öffnen / Stecker (2) aus der Hochvoltbatterie herausziehen