







- ① Akumulator (12 V)      ② Visokonapetostni akumulator      ③ Naprava za izklop visokonapetostnega sistema      ④ Zračna zavesa (samo ZDA)

|  |   |   |   |   |
|--|---|---|---|---|
|  Zračni meh                      |  Plinski generator |  Zateznik varnostnega pasu   |  Plinski tlačni blažilnik    |  Strukturna ojačitev |
|  Krmilnik zadrževalnih sistemov |  Akumulator (12 V) |  Visokonapetostni akumulator |  Visokonapetostne komponente |   |

Napotek: Za več informacij si oglejte naš [reševalni vodnik](#).



## 1. Identifikacija / prepoznavanje

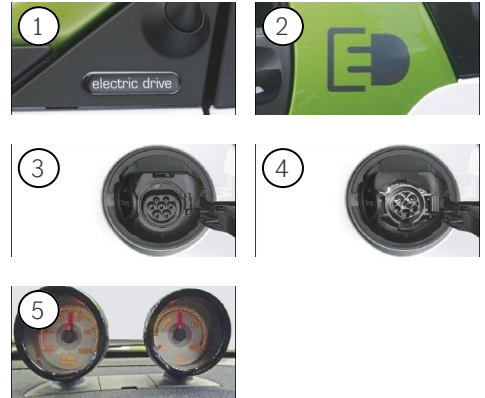
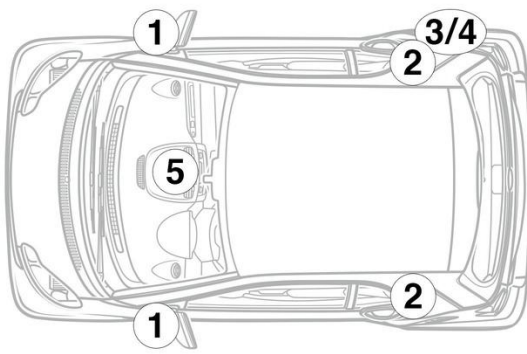

## 3. Onemogočanje neposrednih nevarnosti / varnostni predpisi

### Deaktiviranje visokonapetostnega sistema

V vseh drugih primerih je treba visokonapetostni sistem deaktivirati na naslednji način:

#### Visokonapetostna odklopna naprava



Naprava za izklop visokonapetostnega sistema je nameščena na spodnji strani armaturne plošče v smeri vožnje levo.

Izvlek vtiča (1) iz držala



Da zagotovite, da v visokonapetostnem omrežju ni preostale napetosti, po izklopu počakajte približno 20 sekund.



Pasivne varnostne sisteme, kot so zračne blazine in zategovalnik varnostnega pasu, še naprej napaja 12-voltni električni sistem vozila.



#### Odklop 12-V akumulatorja

1. Odstranite pokrov 12-V akumulatorja.
2. Odvijte negativni kabel 12-V akumulatorja na vijačnem priključku in ga zavarujte pred nenamernim stikom.