









- ① On-board electrical system battery
- ② Additional battery
- ③ High-voltage battery
- ④ High-voltage charge socket

 Airbag	 Gas generator	 Seat belt tensioner	 Restraint systems control unit	 12 V Battery
 High-voltage battery	 High-voltage components	 High-voltage disconnect device	 Alternative high-voltage disconnect device	

Note: Please see our [emergency response guide](#) for more information



1. Identification / recognition

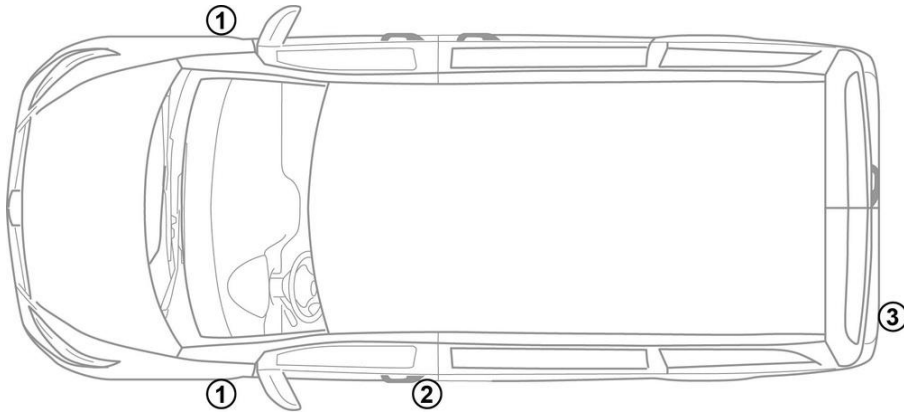

3. Disable direct hazards / safety regulations

Deactivation of the high-voltage system

In all other cases, the high-voltage system should be deactivated as follows:

Option 1: High-voltage disconnect

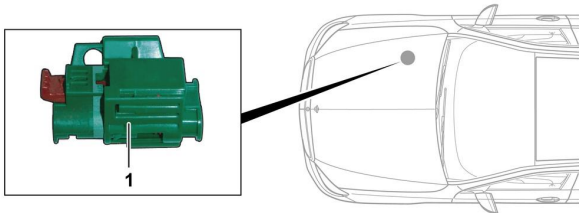

The high-voltage disconnect is located in the engine compartment on the passenger side.

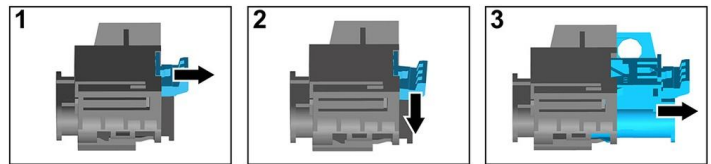

- (1) Pull the release
- (2) Push the release down
- (3) Pull out the switch

Option 2: Alternative high-voltage disconnect

The alternative high-voltage disconnect is located in the base of the right-hand front seat. It is indicated with a sign.



Remove the cover (1). Cut the cable at the marked point (2).



Disconnecting the 12 V battery

1. Remove the cover from the 12-volt battery.
2. Disconnect the negative cable of the 12-volt battery at the screw connection and secure it against unintentional contact.