











-  Airbag
-  Gerador de gás
-  Pré-tensor do cinto de segurança
-  Unidade de controlo SRS
-  Mola de pressão a gás/mola pré-tensionada
-  Bateria de baixa voltagem
-  Bateria de alta tensão
-  Cabo de alimentação de alta tensão
-  Componente de alta tensão
-  Corte de cabo
-  Dispositivo de baixa tensão que desconecta o sistema de alta tensão

Indicação: Para mais informações, por favor consulte o nosso [guia de salvamento](#).



1. Identificação / reconhecimento

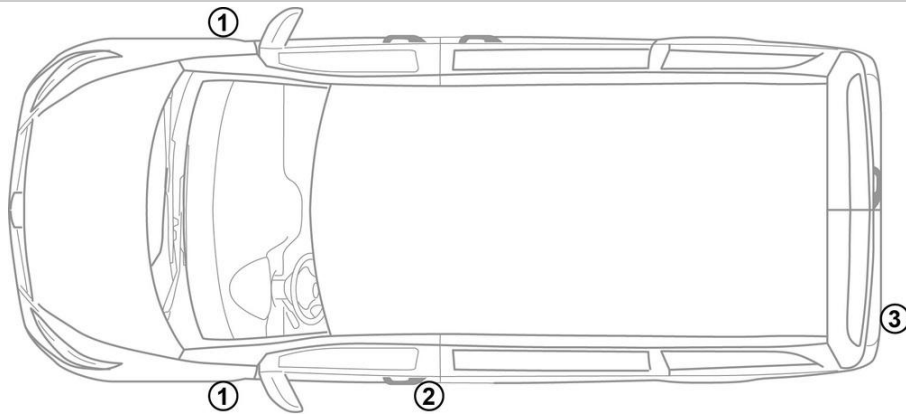

3. Neutralização dos principais perigos / regras de segurança

Desativação do sistema de alta voltagem

Em todos os outros casos, desativar o sistema de alta voltagem da seguinte forma:

Opção 1: Dispositivo de desconexão de alta voltagem

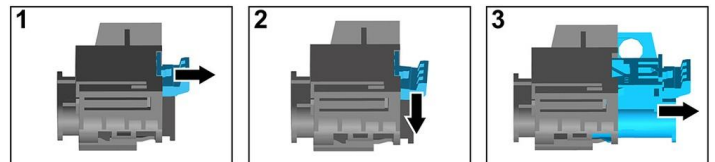
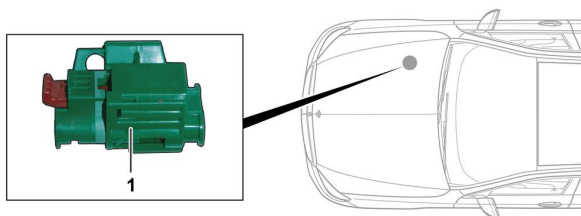

O dispositivo de desconexão de alta voltagem encontra-se no compartimento do motor no lado do acompanhante.



- (1) Puxar o desbloqueio
- (2) Pressionar o desbloqueio para baixo
- (3) Remover o interruptor

Opção 2: Dispositivo de desconexão de alta voltagem alternativo

O dispositivo alternativo de desconexão de alta voltagem está localizado na caixa do banco da frente à direita. É assinalado com um sinal.

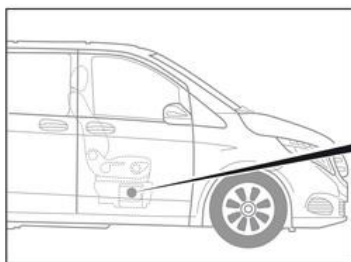

Retirar a cobertura (1). Cortar o cabo no lugar marcado (2).



Desconectar a bateria de 12 V

- 1. Retirar a cobertura das baterias de 12 volts.
- 2. Soltar o cabo negativo da bateria de 12 volts na união roscada e proteger contra contacto involuntário.