







- | | | | | |
|---|--|---|---|---|
|  Krockudde |  Gasgenerator |  Bältesförsträcker |  SRS styrenhet |  Gastrycksdämpare/förspänd fjädrer |
|  Lågvoltbatteri |  Diesel bränsletank | | | |

Observera: Mer information finns i vår [räddningsguide](#).



1. Identifiering

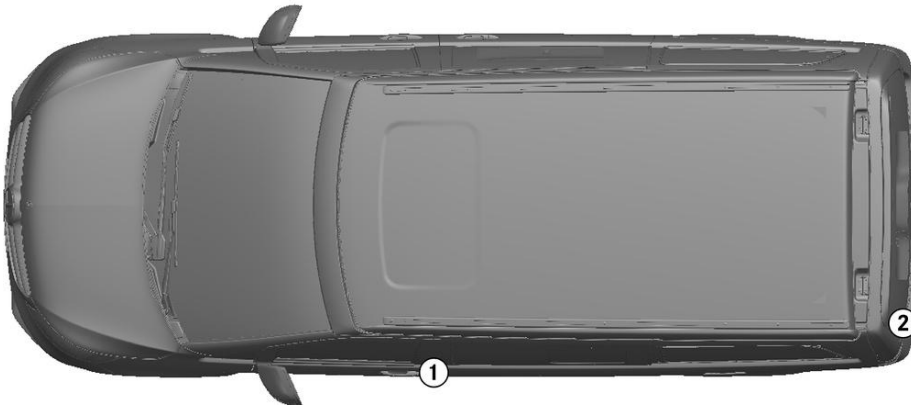

2

MARCO POLO

2. Immobilisering / stabilisering / lyft

Parkeringsbroms

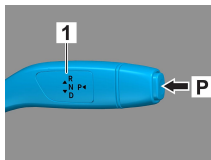

Parkeringsbroms

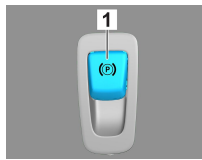

Tryck på strömbrytaren P på växelväljaren (1).
Parkeringsbromsen aktiveras automatiskt.

Elektrisk parkeringsbroms (1)

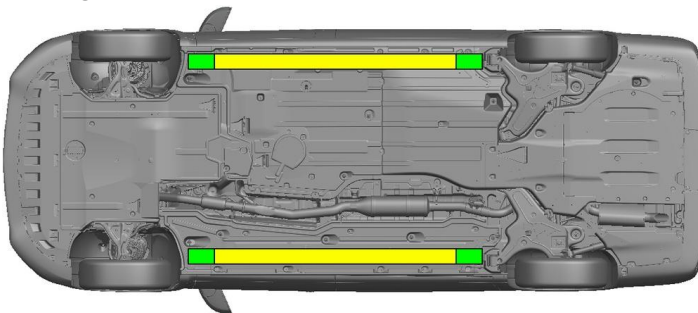

Lämpliga lyftpunkter



Lämpliga stabiliseringspunkter på sidan



Undvik att ytterligare deformera trösklarna och underredet under räddningsinsatsen (exempelvis genom att använda dem som stöd för hydraulisk utrustning).

3. Oskadliggöra akuta risker/ säkerhetsföreskrifter

Slå av tändningen:

1. Tryck på START-STOP-knappen utan att manövrera färdbromsen.
2. Förvara den elektroniska fordonsnyckeln på minst 5 m avstånd.

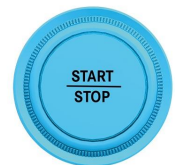
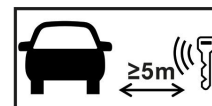

Frånvaron av motorljud är inget säkert tecken på att fordonet är avstängt.



Ny start kan ske tills fordonet har stängts av helt.



Koppla loss 12-voltsbatteriet

1. Ta bort övertäckningen från 12-voltsbatteriet.
2. Lossa minuskabeln från skruvförbandet på 12-voltsbatteriet och säkra den mot oavsiktlig kontakt.



De passiva säkerhetssystemen (airbags och bältesförsträckare) inaktiveras.



4. Åtkomst till passagerare

När personerna i bilen frigörs måste hänsyn tas till säkerhetssystemets komponenter (särskilt pyrotekniska element) i enlighet med informationen på sidan 1.



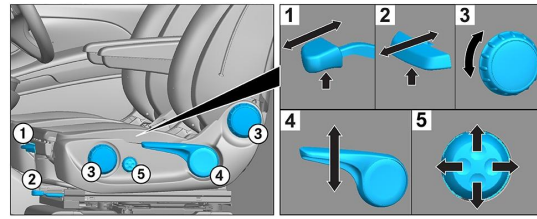

Rattinställning



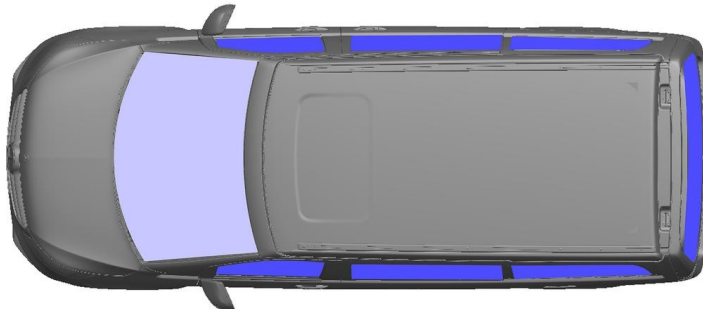











Stolsinställning (mekanisk)



 VSG: Laminerat säkerhetsglas
 ESG: enkelt säkerhetsglas

5. Lagrad energi / vätskor / gaser / fasta ämnen

	   	12V
	 	57L
	  	900 ± 10g

6. I händelse av brand



Använd stora mängder vatten (H₂O) vid släckning av fordonsbränder.

7. Om fordonet är nedsänkt i vatten

Det finns ingen fara för att karossen är spänningssatt. Efter bärgning av fordonet:

1. Låt vattnet rinna ut ur kupén.
2. Inled inaktivering av elsystemet med 12/48 volt (se kapitel 3).

8. Bogsering / transport / förvaring

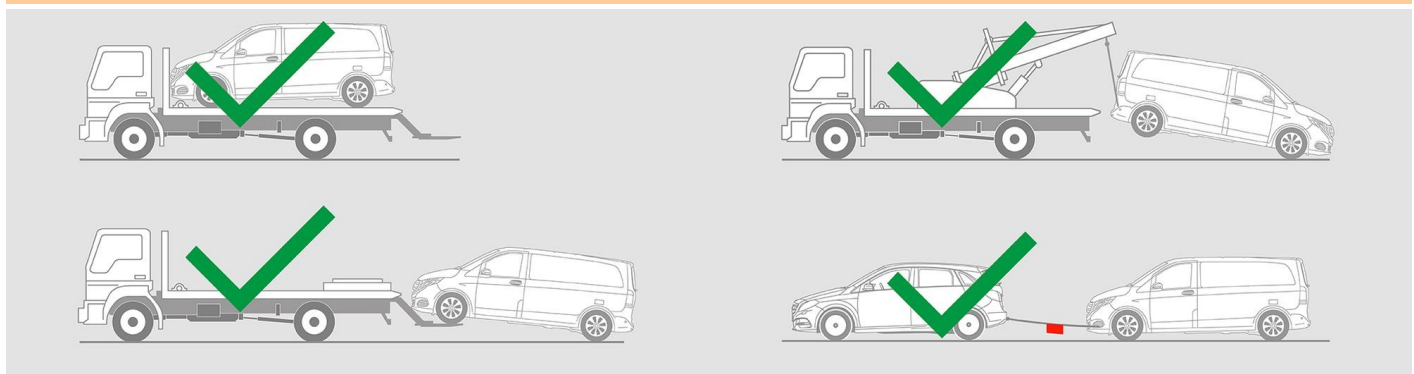



9. Övrig viktig information

Mer information finns i [Guide till personbilsbärgare](#).

10. Förklaring till de pictogram som används



Bränslefordon från
vätskegrupp 1



Allmän varningsskylt



Brandfarligt



Farligt för människors
hälsa



Frätande medel



Explosivt



Använd vatten för att
släcka elden



Använd torrsium för
att släcka elden



Ta bort smartnyckeln



Luftkonditioneringskom-
ponent



Varning, låg temperatur