











-  Kollisjonspute
-  Gassgenerator
-  Beltestrammer
-  SRS styreenhet
-  Gasstrykkdemper / Forspent fjær
-  Faresone
-  Lavvolt-batteri
-  Høyvolt-batteri
-  Høyvolt-kabel
-  Høyvolt-komponenter
-  Høyspenningsskillepunkt

Merknad: Mer informasjon finner du i vår [bergingsveiledning](#).



1. Identifisering / Gjennkjenning

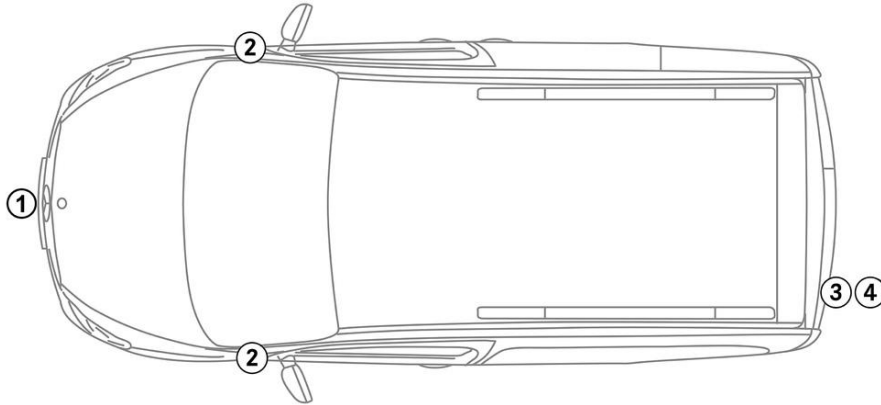

2

ELECTRIC

3 EQT

4

eCITAN

2. Immobilisering / stabilisering / løfting

Parkeringsbrems



Sett girvelgeren (1) i posisjonen P.
Parkeringsbremsen aktiveres automatisk.

Håndbrems

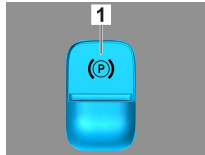

Elektrisk håndbrems (1)

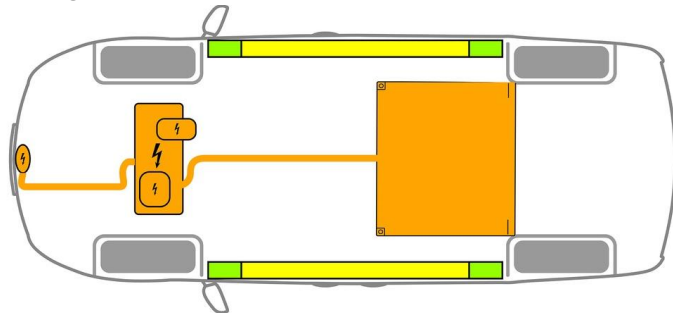

Egnet løftepunkt



Egnet stabilisering på siden



Høyspenningssystem



En ekstra misforming av travers og underrammen må unngås under bergingen (f.eks. gjennom å støtte med hydraulikkutstyr).

3. Deaktivere direkte farer / sikkerhets regler

Main Method

Slå tenningen av:

1. Trykk på START-STOPP-knappen, uten å aktivere motorbremsen.
2. Oppbevar den elektroniske bilnøkkelen i en avstand på minst 5 m.

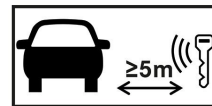

Selv om du ikke kan høre om motoren går, betyr ikke dette at bilen er slått av.



Bilen kan starte på nytt, helt til den settes ut av drift.

Deaktivere høyspenningssystemet



Ved ulykker der airbagger og beltestrammere har utløst slås høyspenningssystemet av automatisk.





Alternative Method

I alle andre tilfeller skal høyspenningssystemet deaktiveres som følger:



Innretning for utkobling av høyspenning

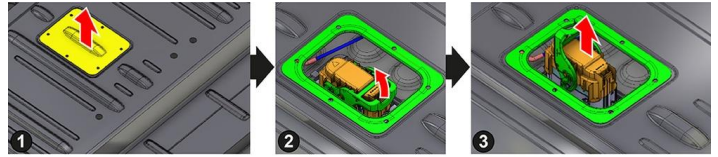
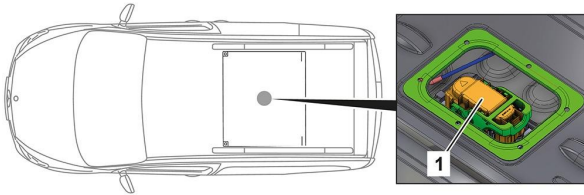

Høyvolt-utkoblingsanordningen er plassert i motorrommet på førersiden. Skyv den bakre seteбенken fremover og løft.

- (1) Fjern støvhetten og dekkhetten
- (2) Lås opp støpselet
- (3) Trekk ut støpselet

Høyvoltutkoblingsanordningen befinner seg innvendig på oversiden av høyvoltbatteriet.



Vent i ca. 20 sekunder etter utkobling for å sikre at det ikke ligger restspenning i høyspenningsnett.



De passive sikkerhetssystemene, som airbagger og beltestrammere, forsynes fremdeles med spenning via ledningsnett på 12 V.

Access



Klem av 12-V-batteriet



- 1. Fjern dekselet på 12-V-batteriet i motorrommet.
- 2. Løsne skruforbindingen på minuskabelen til 12-V-batteriet, og sikre mot utilsiktet kontakt.



De passive sikkerhetssystemene (airbagger og beltestrammere) deaktiveres.

4. Tilgang til fører/passasjerer

Under redningen av personene i bilen skal man ta hensyn til komponentene til passasjersikringssystemet (spesielt pyrotekniske elementer) i henhold til opplysningene på side 1.

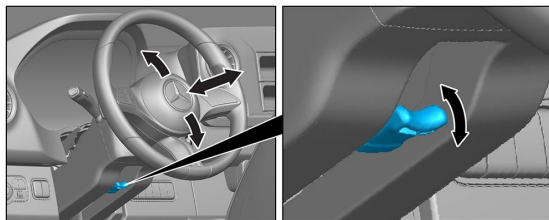

Rattinnstilling

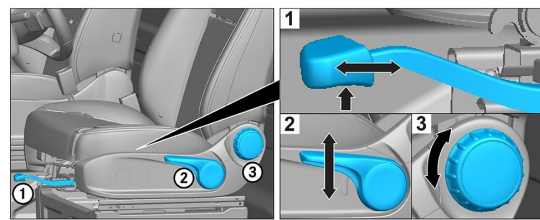

Seteinntilling (mekanisk)

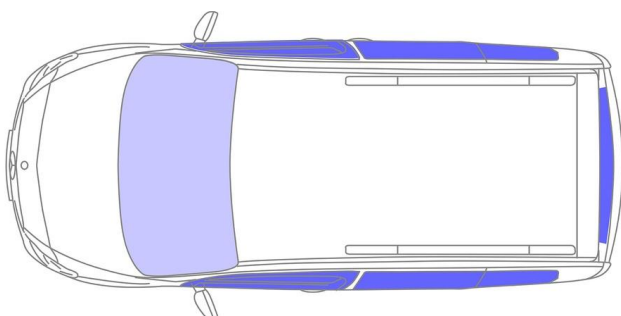

- VSG: Laminert sikkerhetsglass
- ESG: Herdet sikkerhetsglass



5. Lagret energi / væske / gass / fast



Alle høyspenningsledninger er forsynt med en orasjefarget isolasjon.

6. I tilfelle brann



Fireman Access behind the second row of seats.



Bruk store mengder vann (H₂O) når du slukker en bilbrann.
Bruk store mengder vann (H₂O) for å kjøle li-ionbatteriet.

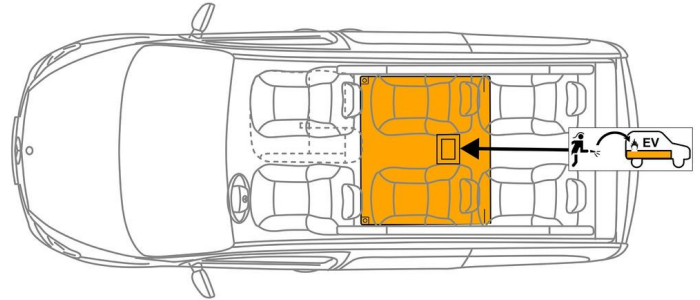

Advarsel: Batteriets kan antennes igjen



Når det siver ut kjølemiddel fra høyspenningsbatteriet, kan batteriet bli ustabil på grunn av termisk overbelastning.
Kontroller batteritemperaturen med et IR-varmebildekamera.



7. I tilfelle nedsenket i vann/sjø

Det foreligger ikke fare for at spenningen går over på karosseriet.

Etter at bilen er berget:

1. Slipp ut vannet fra bilens innside.
2. Begynn med å deaktivere høyspenningssystemet (se kapittel 3).

8. Tauing / transport / lagring

Bilen skal kun transporteres med begge akslene på en slepebil eller en biltransporter.

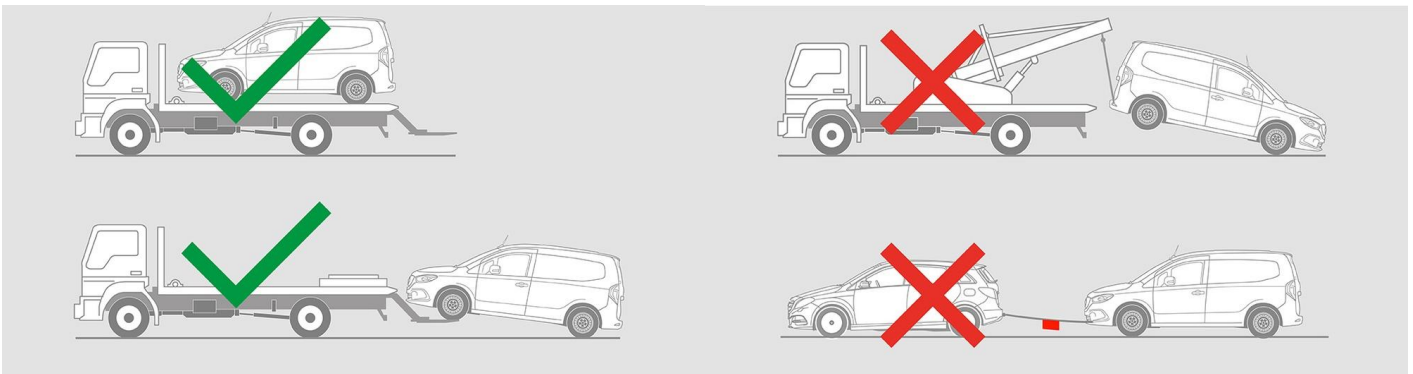

Oppbevares i sikker avstand til andre biler.



Advarsel: Batteriets kan antennes igjen



9. Viktig ekstra informasjon

Mer informasjon finner du i [Veiledning for slepetjenester for sleping av personbil](#).



10. Forklaring av piktogrammer



Elkjøretøy



Fare



Fare! El. spenning!



Brennbar



Helsefarlig



Korroderende



Akutt toksisitet



Slukke med vann



Safety gloves



Face shield



Bruk IR-
varmebildekamera



Panser



Fjern smartnøkkel



Special battery access