











-  气囊
-  气体发生器
-  安全带预紧器
-  SRS 控制单元
-  气体压力缓冲器/预压紧的弹簧
-  注意区域
-  低电压蓄电池
-  电池组, 高压
-  高压电力电缆
-  高压组件
-  断开高压的高压装置

提示: 详细信息请参见[救援指南](#)。



1. 确认/识别

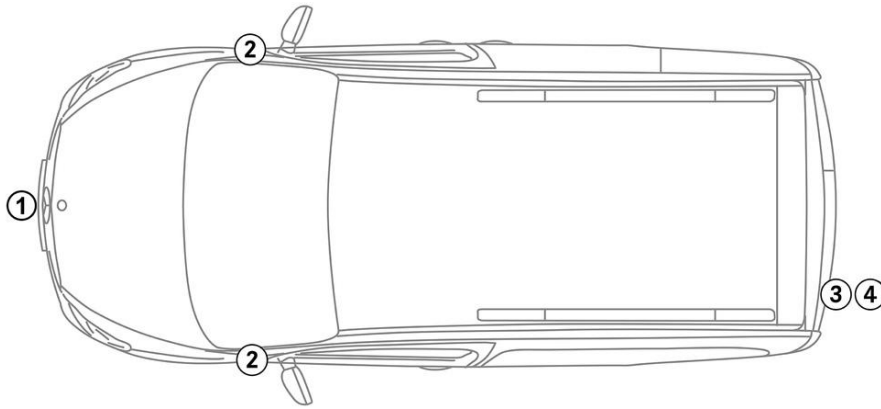

2. 固定/稳定/抬升

手刹



1. 将换挡杆 压至位置 P

驻车制动器

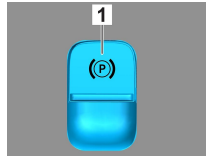

1. 电动驻车制动器

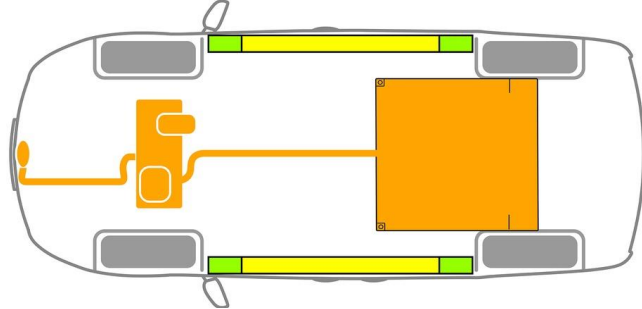

- 适当的提升点
- 侧面上适当的稳定点
- 高压电池



救援期间必须避免车门门槛结构和车身底板发生额外的变形（例如用千斤顶撑住）。

3. 消除威胁/安全规章

Main Method

关闭点火装置：

1. 按下启停按钮，而不要操作行车制动器。
2. 将电子车钥匙放在至少 5 米以外。

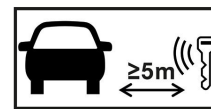

发动机没有发出声音，并不意味着车辆就已经熄火了。



在车辆熄火之前均可重启。

停用高压系统



若是事故发生时触发了安全气囊和安全带拉紧器，将会自动关闭高压系统。





Alternative Method

而在其他情况下，如下停用高压系统：



高压断开装置

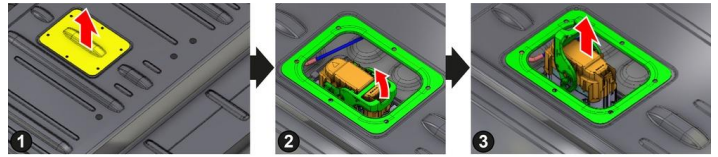
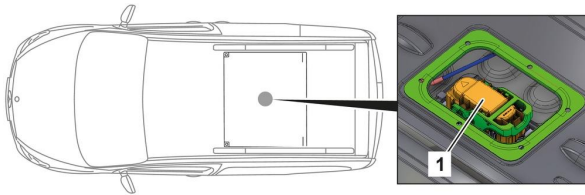

高电压断开装置位于驾驶员侧发动机舱中。
将后侧长座椅向前推并抬起。
高电压断开装置位于 车内高电压蓄电池上方。

- (1) 移除防尘盖和盖罩
- (2) 解锁插头
- (3) 拔出插头



为确保高压电网中不再有残余电压，关闭后等待大约 20 秒。



安全气囊和安全带拉紧器等无源安全系统将继续由 12V 车载电气系统供电。

Access



断开 12V 电池连接



- 1. 取掉发动机舱中的 12V 电池的盖板。
- 2. 松开螺栓连接上 12V 电池的负极电缆，并将其固定好，防止无意接触。



停用无源安全系统（安全气囊和安全带拉紧器）。

4. 救援通道搭建

解救车辆驾驶员及乘客时应根据第 1 页上的说明考虑到约束系统的部件（尤其是爆燃元件）。

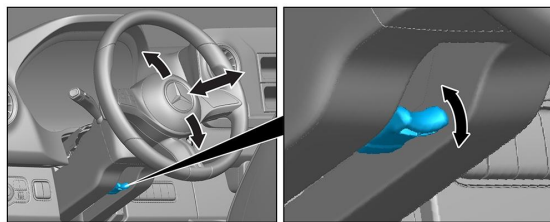

方向盘调节

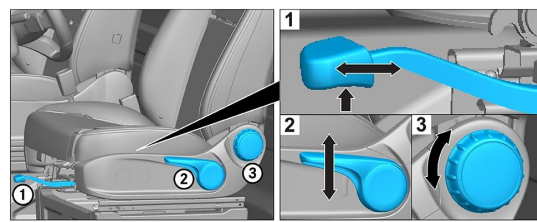

座椅调节（机械）

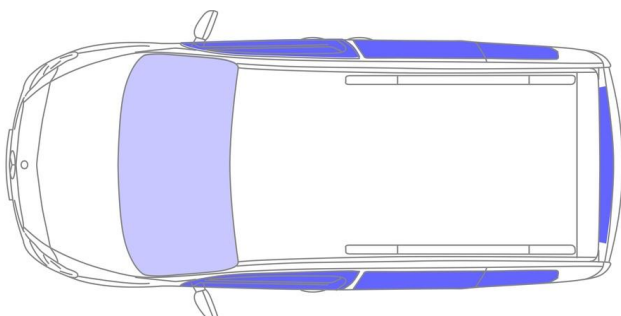

VSG：夹层安全玻璃

ESG：单层安全玻璃



5. 剩余电量 / 液化气/燃油 / 固体燃料



所有高压电缆都装设有橘黄色的绝缘层。

6. 车辆起火



Fireman Access is in the second row of seats under the bench seat.

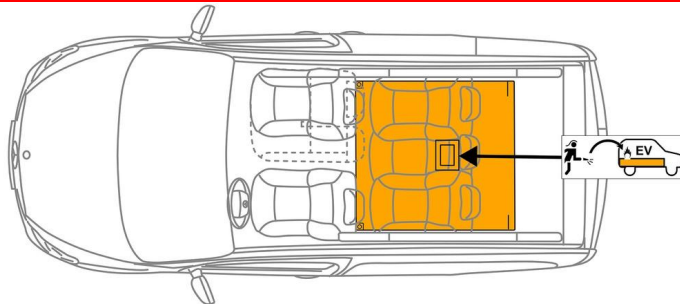

使用大量的水 (H₂O) 灭火。
使用大量的水 (H₂O) 冷却锂离子电池。



警告：电池重新点燃。



如果冷却液从高压电池中漏出，由于热过载，冷却液可能变得不稳定。用红外热像仪检查电池温度。



7. 车辆淹没

没有车身通电的危险。

打捞车辆后：

1. 把水从汽车内室中排出。
2. 停用高压系统（参见第3章）。

8. 牵引 / 转移 / 存放

运输车辆时，车辆的双轴都必须处在拖车或车辆运输车上。

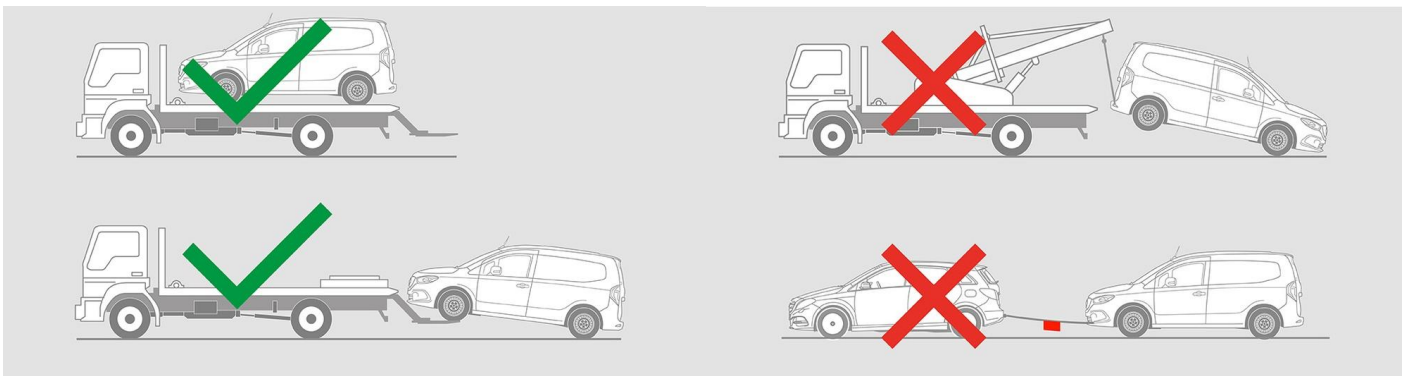

与其他车辆保持安全距离。



警告：电池重新点燃。



9. 其他重要信息

更多信息请查看 [乘用车拖车服务指南](#)。



10. 使用图示的释义



电动汽车



一般警告标志



警告，电力



易燃



对人体健康有害



腐蚀性物质



急性毒性



用水灭火



Safety gloves



Face shield



使用热红外摄像机



发动机罩



移除智能钥匙



专用电池检修口