











-  气囊
-  气体发生器
-  安全带预紧器
-  SRS 控制单元
-  气体压力缓冲器/预压紧的弹簧
-  注意区域
-  低电压蓄电池
-  电池组, 高压
-  高压电力电缆
-  高压组件
-  断开高压的高压装置

提示: 详细信息请参见[救援指南](#)。



1. 确认/识别

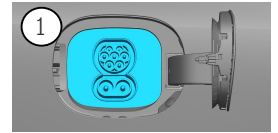
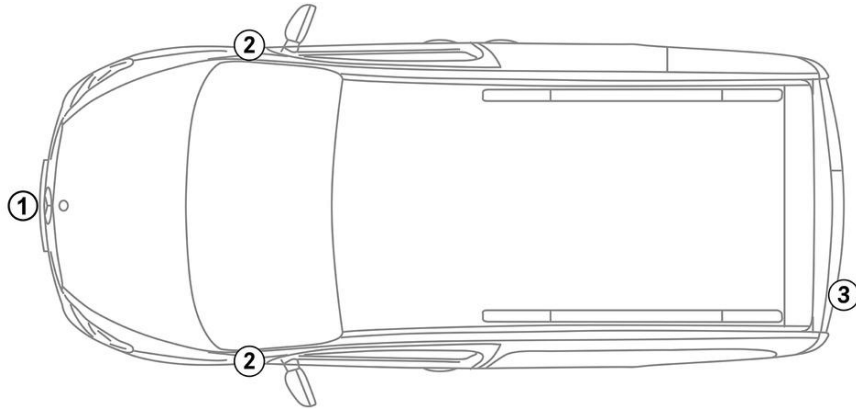

2. 固定/稳定/抬升

手刹



1. 将换挡杆 压至位置 P

驻车制动器

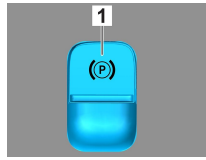

1. 电动驻车制动器

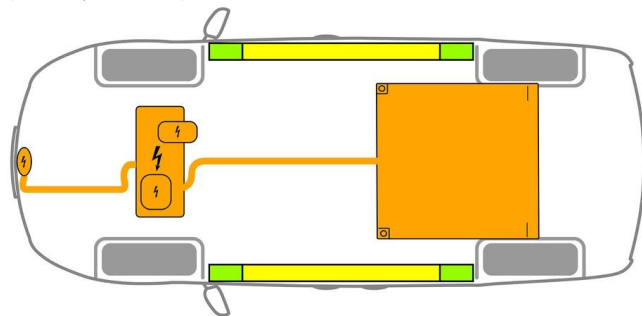

适当的提升点

侧面上适当的稳定点

高压电池



救援期间必须避免车门门槛结构和车身底板发生额外的变形（例如用千斤顶撑住）。

3. 消除威胁/安全规章

关闭点火装置：

1. 按下启停按钮，而不要操作行车制动器。
2. 将电子车钥匙放在至少 5 米以外。

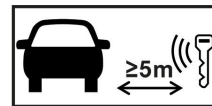

发动机没有发出声音，并不意味着车辆就已经熄火了。



在车辆熄火之前均可重启。

停用高压系统



若是事故发生时触发了安全气囊和安全带拉紧器，将会自动关闭高压系统。





而在其他情况下, 如下停用高压系统:



选项 1: 高压断开装置

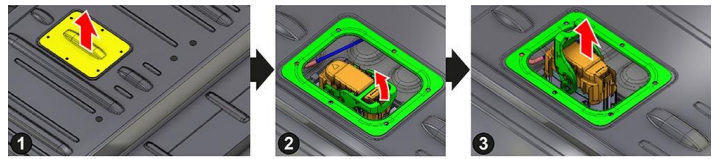
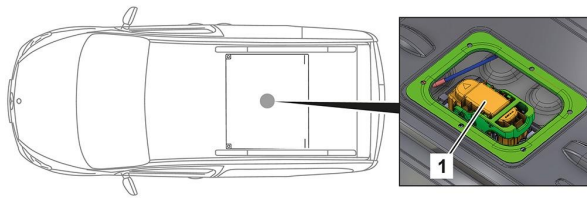

高电压断开装置位于驾驶员侧发动机舱中。

将后侧长座椅向前推并抬起。

高电压断开装置位于 车内高电压蓄电池上方。

(1) 移除防尘盖和盖罩

(2) 解锁插头

(3) 拔出插头



为确保高压电网中不再有残余电压, 关闭后等待大约 20 秒。



安全气囊和安全带拉紧器等无源安全系统将 继续由 12V 车载电气系统供电。



断开 12V 电池连接

1. 取掉发动机舱中的 12V 电池的盖板。
2. 松开螺栓连接上 12V 电池的负极电缆, 并将其固定好, 防止无意接触。



停用无源安全系统 (安全气囊和安全带拉紧器)。

4. 救援通道搭建

解救车辆驾驶员及乘客时应根据第 1 页上的说明考虑到约束系统的部件 (尤其是爆燃元件)。

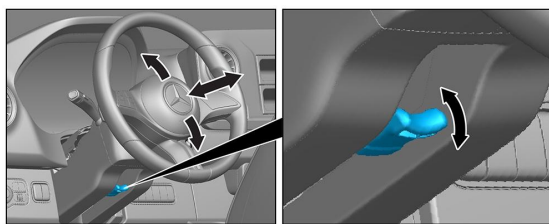

方向盘调节

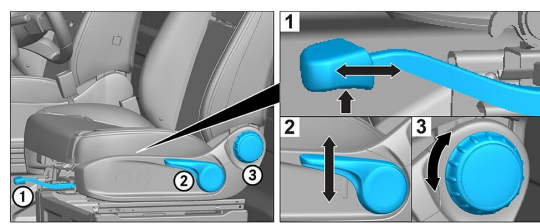

座椅调节 (机械)

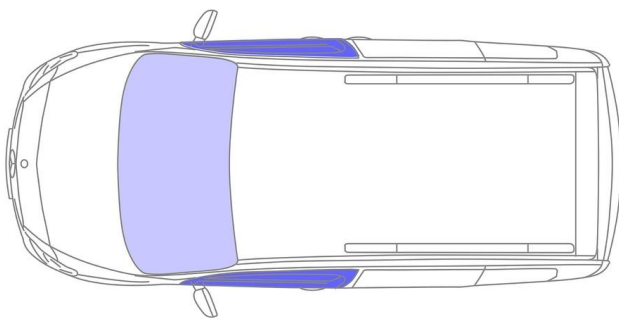

VSG : 夹层安全玻璃

ESG : 单层安全玻璃



5. 剩余电量 / 液化气/燃油 / 固体燃料



所有高压电缆都装设有橘黄色的绝缘层。

6. 车辆起火



Fireman Access in the hold.



使用大量的水 (H₂O) 灭火。
使用大量的水 (H₂O) 冷却锂离子电池。

警告：电池重新点燃。



如果冷却液从高压电池中漏出，由于热过载，冷却液可能变得不稳定。用红外热像仪检查电池温度。



7. 车辆淹没

没有车身通电的危险。

打捞车辆后：

1. 把水从汽车内室中排出。
2. 停用高压系统（参见第3章）。

8. 牵引 / 转移 / 存放

运输车辆时，车辆的双轴都必须处在拖车或车辆运输车上。

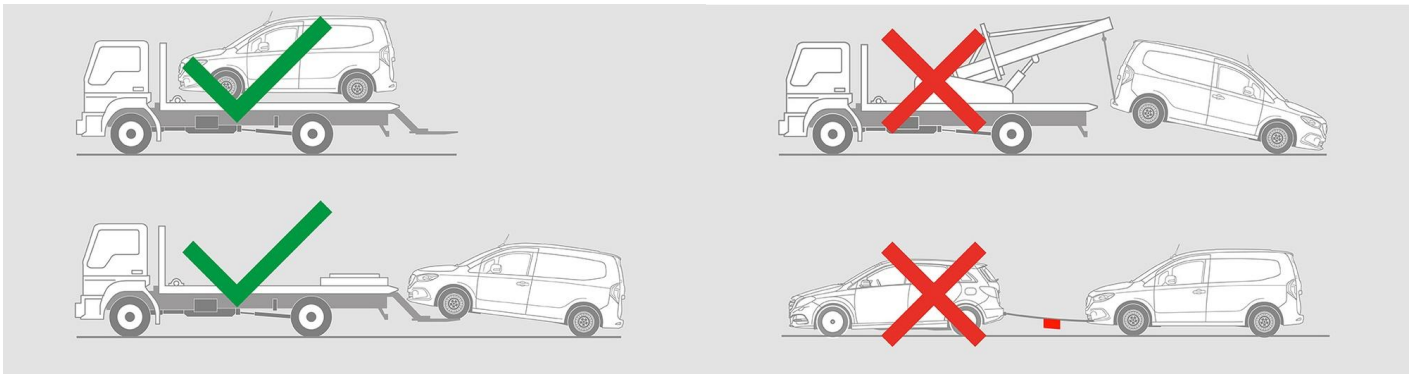

与其他车辆保持安全距离。

警告：电池重新点燃。



9. 其他重要信息

更多信息请查看 [乘用车拖车服务指南](#)。



10. 使用图示的释义



电动汽车



一般警告标志



警告, 电力



易燃



对人体健康有害



腐蚀性物质



急性毒性



用水灭火



Safety gloves



Face shield



使用热红外摄像机



发动机罩



移除智能钥匙



专用电池检修口