

- ① 12 V 主蓄电池
- ② 12 V 附加蓄电池
- ③ 高压蓄电池
- ④ 高压断路装置
- ⑤ 备用高压断路装置, 左舵驾驶车辆
- ⑥ 备用高压断路装置, 右舵驾驶车辆
- ⑦ 高电压充电插座

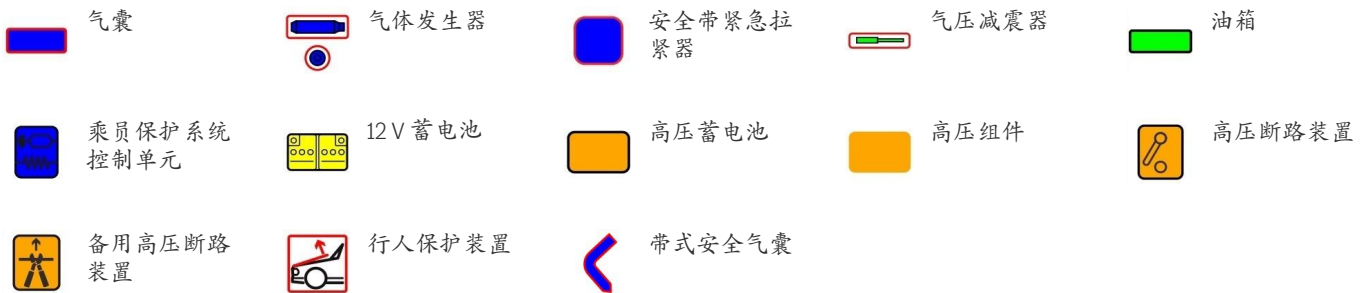

提示: 详细信息请参见[救援指南](#)。



1. 确认/识别

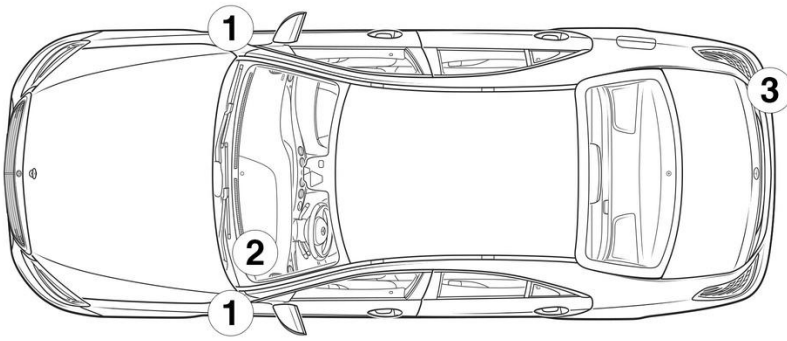

2. 固定/稳定/抬升

手刹



驻车制动器



按下选挡杆(1)上的开关 P。自动激活手刹。

电动驻车制动器(1)

3. 消除威胁/安全规章

关闭点火装置：

1. 按下启停按钮，而不要操作行车制动器。
2. 将电子车钥匙放在至少 5 米以外。

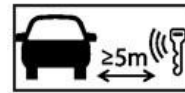

发动机没有发出声音，并不意味着车辆就已经熄火了。



在车辆熄火之前均可重启。

停用高压系统



若是事故发生时触发了安全气囊和安全带拉紧器，将会自动关闭高压系统。



而在其他情况下，如下停用高压系统：

选项 1: 高压断开装置

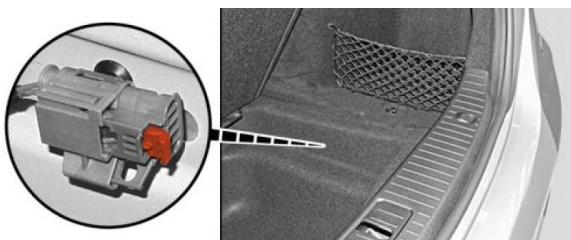

高压断路装置位于右后行李箱槽盖板下方。通过车辆中心承载梁下方的拉片将槽饰板从行李箱中拔出。

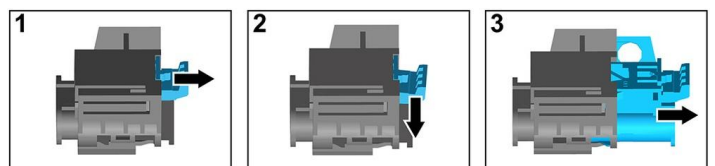

- (1) 拉动解锁装置
- (2) 向下按下解锁装置
- (3) 拉出开关



选项 2: 备用高压断开装置

备用高压断开装置位于驾驶员侧驾驶舱的保险丝盒盖板下方。
备用高压断开装置用指示牌标记。

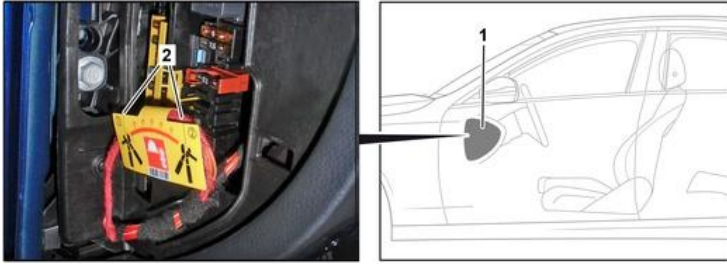

取掉盖板 (1)。在标记点 (2) 处切断电线。



为确保高压电网中不再有残余电压，关闭后等待大约 20 秒。



安全气囊和安全带拉紧器等无源安全系统将继续由 12V 车载电气系统供电。



断开 12/48V 电池连接

1. 取掉行李厢中的 12/48V 电池的盖板。
2. 松开螺栓连接上 12/48V 电池的负极电缆，并将其固定好，防止无意接触。



8. 牵引 / 转移 / 存放

运输车辆时，车辆的双轴都必须处在拖车或车辆运输车上。

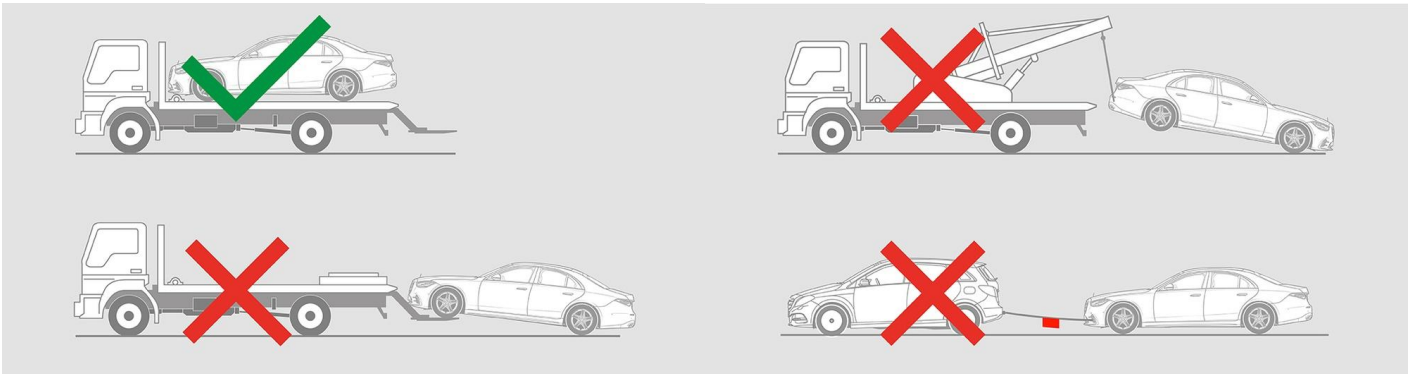

与其他车辆保持安全距离。



警告：电池重新点燃。

