

- ① 12 伏特電池
- ② 12 伏特 輔助電瓶
- ③ 高電壓電池
- ④ 高電壓關閉裝置
- ⑤ 替代高電壓關閉裝置, 左駕車輛
- ⑥ 替代高電壓關閉裝置, 右駕車輛
- ⑦ 高電壓充電插座

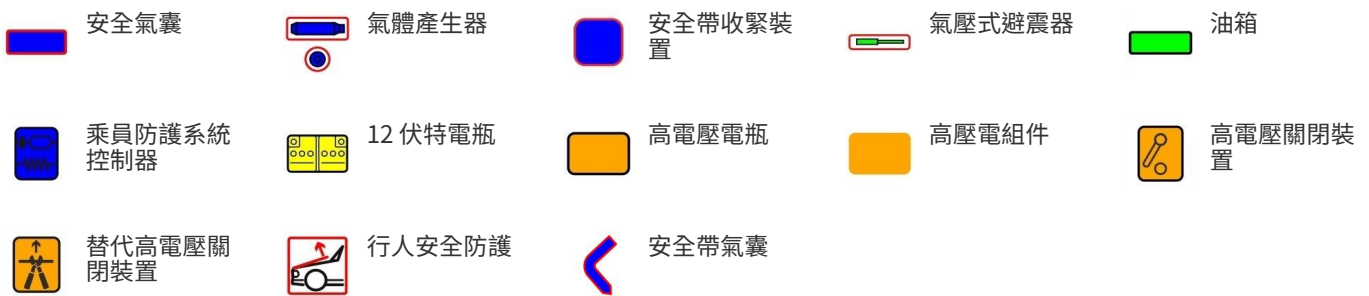

提醒: 詳細訊息請參考 [救援指南](#)。



### 1. 確認/識別

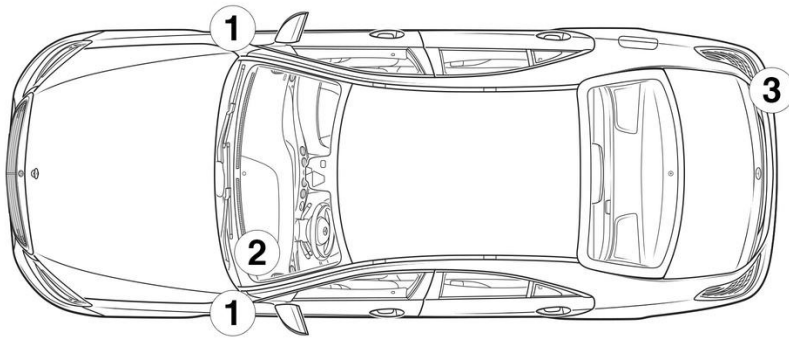

### 2. 固定/穩定/升降

手煞車

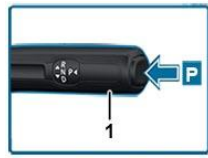
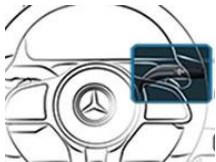

手煞車



按下選檔桿 (1) 上的開關 P。電動手煞車即 電動手煞車 (1) 自動啟動。

### 3. 解除直接危害/安全規章

關閉點火開關：

1. 按下啟動/停止按鈕，而不要觸發主煞車。
2. 將電子車鑰匙放在至少 5 公尺之外。

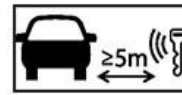

沒有引擎噪音並不表示車輛已關閉。



車輛關閉之前可以重新啟動。

停用高壓系統



若事故發生時觸發了安全氣囊和安全帶收緊裝置，將會自動關閉高壓系統。



在必要的狀況下，高壓系統應依照以下方式關閉：

選項 1: 高壓斷開裝置

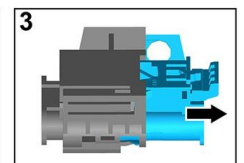
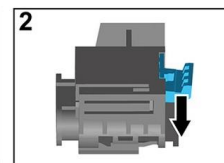
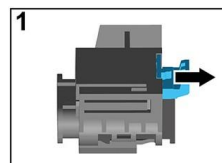
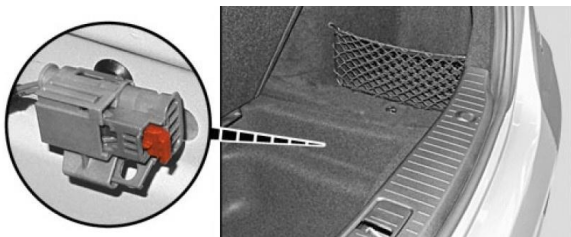

高電壓關閉裝置位在下行李廂凹槽護蓋下方右後側。拉住車輛中間位於尾門檔下方的拉環，將凹槽隔板自行行李箱中 拉出。



- (1) 拉動解鎖裝置
- (2) 按下解鎖裝置
- (3) 拔出開關



選項 2: 替代高壓斷開裝置

替代高壓斷開裝置位於駕駛艙駕駛員側的保險絲盒蓋下方，並且有標示提醒。

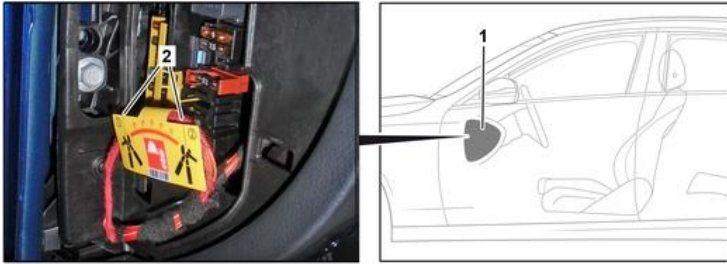

拆下蓋板 (1)。從標記點 (2) 處切斷電纜。



為確保高壓網絡中沒有殘餘電壓，請在關閉後等待約 20 秒。



安全氣囊和安全帶張緊器等被動安全系統繼續由 12 伏車輛電氣系統供電。



斷開 12V/48V 電瓶

1. 拆下後備箱中的 12/48 伏電池蓋。
2. 鬆開螺絲連接處的 12/48 伏電瓶負極電纜，並防止意外接觸。



### 8. 拖吊/運輸/存放

運輸車輛時，車輛的四輪都必須位於拖吊車或運輸車輛上。

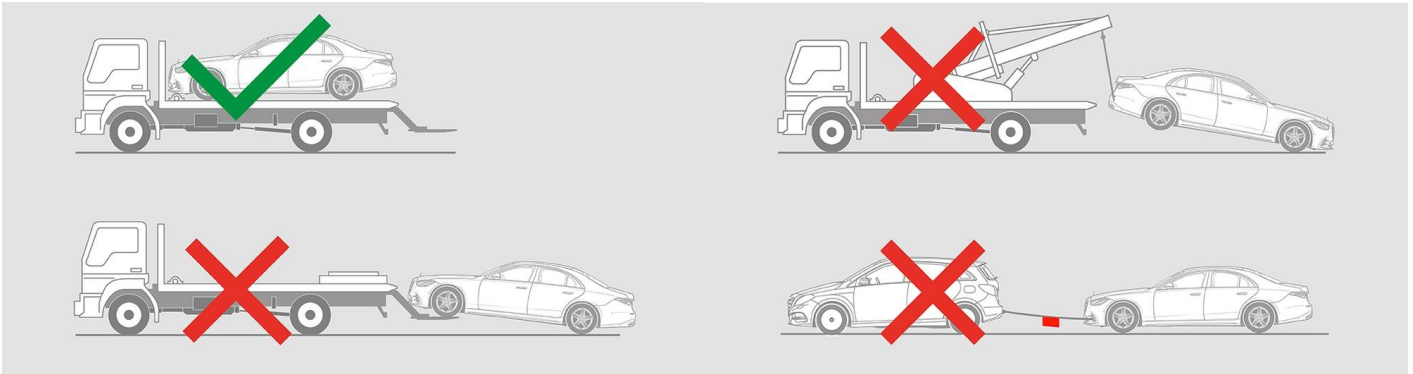

與其他車輛保持安全距離。



警告：電池再次燃燒。

