













-  Kollisjonspute
-  Gassgenerator
-  Beltestrammer
-  SRS styreenhet
-  Aktivt fotgjengerbeskyttelsessystem
-  Gasstrykkdemper / Forspent fjær
-  Lavvolt-batteri
-  Diesel drivstofftank
-  Høyvolt-batteri
-  Høyvolt-kabel
-  Høyvolt-komponenter
-  Alternativ innretning for utkobling av høyspenning
-  Høyspenningsskillepunkt (lavspenningselement)

Merknad: Mer informasjon finner du i vår [bergingsveiledning](#).



1. Identifisering / Gjennkjenning

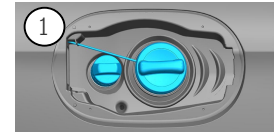

E 300 de

2. Immobilisering / stabilisering / løfting

Parkeringsbrems

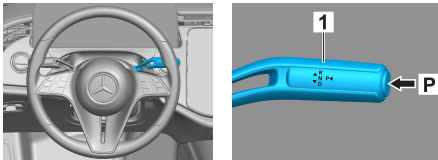

Trykk på bryter P på girvelgeren (1).
Parkeringsbremsen aktiveres automatisk.

Håndbrems

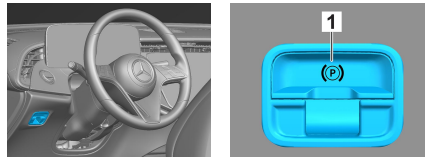

Elektrisk håndbrems (1)

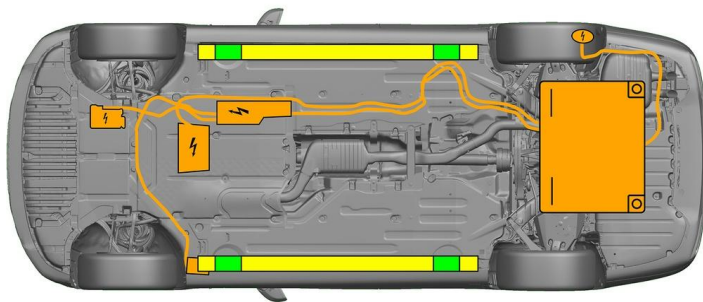

-  Eget løftepunkt
-  Eget stabilisering på siden
-  Høyspenningsbatteri



En ekstra misforming av travers og underrammen må unngås under bergingen (f.eks. gjennom å støtte med hydraulikkutstyr).

3. Deaktivere direkte farer / sikkerhets regler

Slå tenningen av:

1. Trykk på START-STOPP-knappen, uten å aktivere motorbremsen.
2. Oppbevar den elektroniske bilnøkkelen i en avstand på minst 5 m.

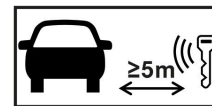

Selv om du ikke kan høre om motoren går, betyr ikke dette at bilen er slått av.



Bilen kan starte på nytt, helt til den settes ut av drift.

Deaktivere høyspenningssystemet



Ved ulykker der airbagger og beltestrammere har utløst slås høyspenningssystemet av automatisk.





I alle andre tilfeller skal høyspenningssystemet deaktiveres som følger:

Alternativ 1: Innretning for utkobling av høyspenning

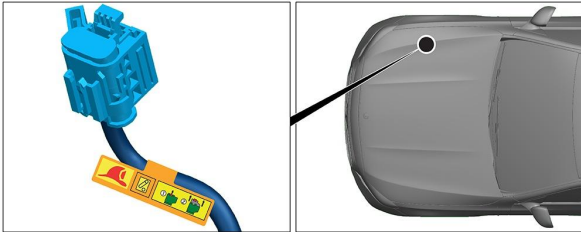

Innretningen for utkobling av høyspenning er plassert i motorrommet på passasjersiden.

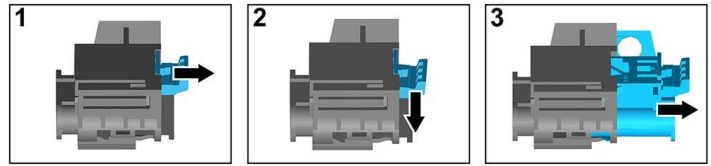

- (1) Trekk i opplåsingsspaken
- (2) Trykk opplåsingsspaken nedover
- (3) Trekk ut bryteren



Alternativ 2: Alternativ innretning for utkobling av høyspenning

Den alternative innretningen for utkobling av høyspenning er plassert under dekselet til sikringsboksen på cockpiten på førersiden. Den er merket med et henvisningsskilt.

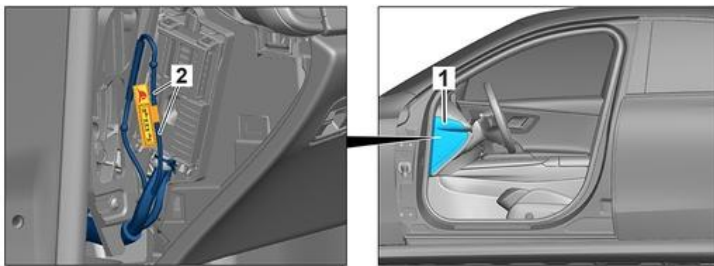

Fjern deksel (1) Kutt opp på markert punkt (2).



Vent i ca. 20 sekunder etter utkobling for å sikre at det ikke ligger restspenning i høyspenningsnett.



De passive sikkerhetssystemene, som airbagger og beltestrammere, forsynes fremdeles med spenning via ledningsnett på 12 V.



Klem av 12-V-batteriet

1. Fjern dekselet på 12-V-batteriet i motorrommet.
2. Løsne skruforbindelsen på minuskabelen til 12-V-batteriet, og sikre mot utilsiktet kontakt.



De passive sikkerhetssystemene (airbagger og beltestrammere) deaktiveres.



4. Tilgang til fører/passasjerer

Under redningen av personene i bilen skal man ta hensyn til komponentene til passasjersikringssystemet (spesielt pyrotekniske elementer) i henhold til opplysningene på side 1.

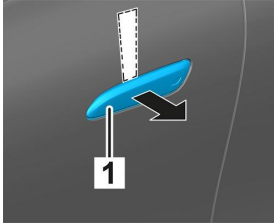

Skyv en flat, ikke-metallisk gjenstand ovenfra og ned bak det innfelte dørhåndtaket (1) og løft det lett utover.

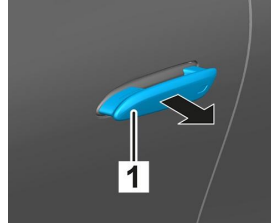

Grip håndtaket (1) nedenfor, og trekk det utover til du kjenner motstand, hold det fast.

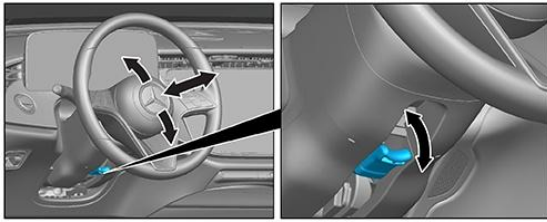

Rattinnstilling

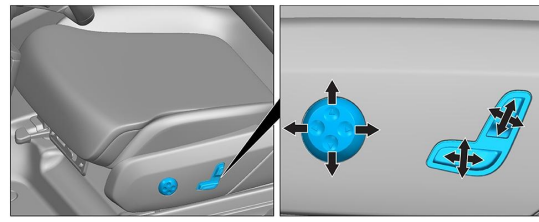

Seteinntilling (elektrisk)

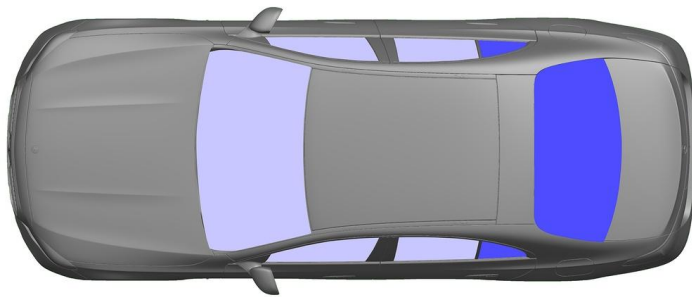

- VSG: Laminert sikkerhetsglass
- ESG: Herdet sikkerhetsglass

5. Lagret energi / væske / gass / fast

		12V
		400V
		50L
		630 ± 10g



Alle høyspenningsledninger er forsynt med en orasjefarget isolasjon.





6. I tilfelle brann



Bruk store mengder vann (H₂O) når du slukker en bilbrann.
Bruk store mengder vann (H₂O) for å kjøle li-ionbatteriet.



Advarsel: Batteriets kan antennes igjen



Når det siver ut kjølemiddel fra høyspenningsbatteriet, kan batteriet bli ustabil på grunn av termisk overbelastning.
Kontroller batteritemperaturen med et IR-varmebildekamera.



7. I tilfelle nedsenket i vann/sjø

Det foreligger ikke fare for at spenningen går over på karosseriet.

Etter at bilen er berget:

1. Slipp ut vannet fra bilens innside.
2. Begynn med å deaktivere høyspenningssystemet (se kapittel 3).

8. Tauing / transport / lagring

Bilen skal kun transporteres med begge akslene på en slepebil eller en biltransporter.

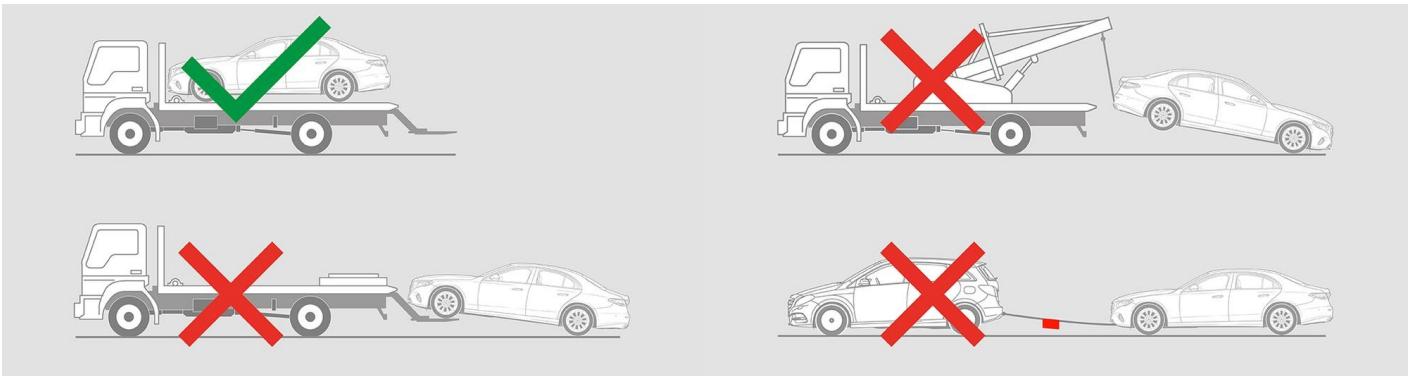

Oppbevares i sikker avstand til andre biler.



Advarsel: Batteriets kan antennes igjen



9. Viktig ekstra informasjon

Mer informasjon finner du i [Veiledning for slepetjenester for sleping av personbil](#).

10. Forklaring av piktogrammer



Elektrohybridkjøretøy med flytende drivstoff kl. 1



Fare



Fare! El. spenning!



Brennbar



Helsefarlig



Korroderende



Akutt toksisitet



Ekspllosiv



Slukke med vann



Bruk IR-varmebildekamera



Panser



Fjern smartnøkkel



Air-conditioning component



Warning; low temperature