













- | | | | | | | | | | |
|---|--------------------------------------|---|---------------------|---|---|---|-----------------------|---|--------------------------------|
|  | Airbag |  | Gasgenerator |  | Gurtstraffer |  | SRS Steuergerät |  | Aktives Fußgängerschutz-System |
|  | Gasdruckdämpfer / vorgespannte Feder |  | Niedervolt-Batterie |  | Diesel Treibstoff-tank |  | Hochspannungsbatterie |  | Hochspannungskabel |
|  | Hochspannungskomponente |  | Kabeltrennstelle |  | Hochvolt-Trennung an Niedervolt-Trennstelle | | | | |

Hinweis: Weiterführende Informationen entnehmen Sie bitte unserem [Rettungsleitfaden](#).



1. Identifizierung / Erkennung

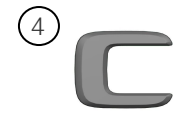
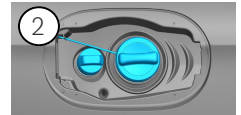
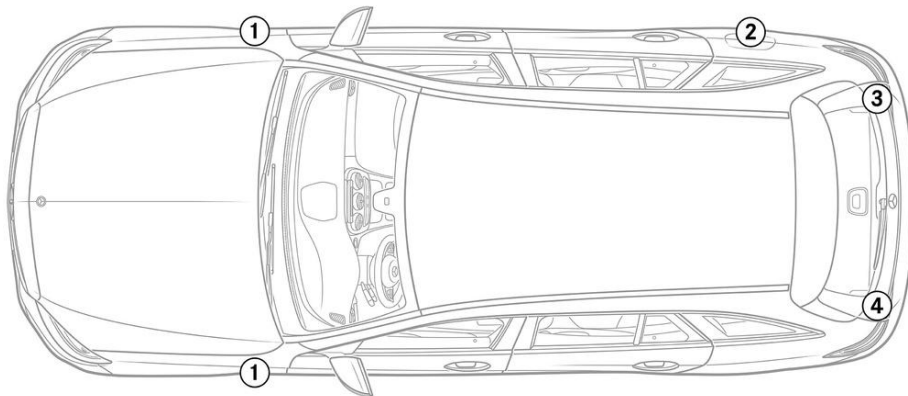

3. Direkte Gefahren ausschalten / Sicherheitsbestimmungen

Deaktivierung des Hochvoltsystems

In allen anderen Fällen ist das Hochvoltsystem wie folgt zu deaktivieren:

Option 1: Hochvoltabschaltvorrichtung

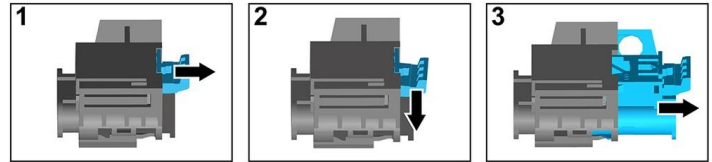
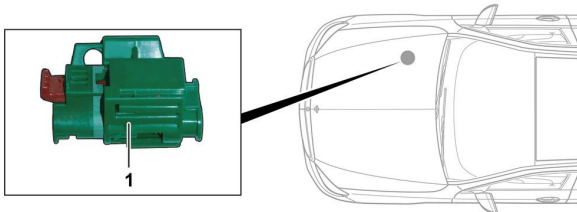

Die Hochvolt-Abschaltvorrichtung befindet sich im Motorraum auf der Beifahrerseite.



- (1) Entriegelung ziehen
- (2) Entriegelung nach unten drücken
- (3) Schalter herausziehen



Option 2: Alternative Hochvoltabschaltvorrichtung



Die alternative Hochvolt-Abschaltvorrichtung befindet sich unter der Abdeckung des Sicherungskastens am Cockpit auf der Fahrerseite. Sie ist mit einem Hinweisschild gekennzeichnet.

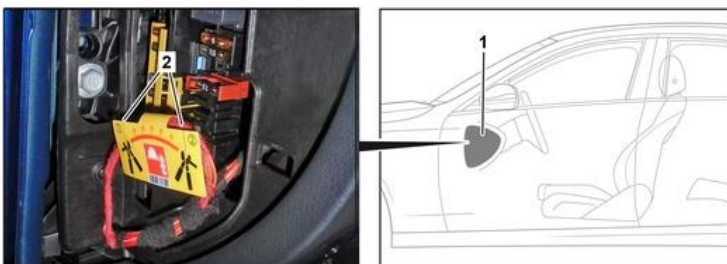

Abdeckung (1) entfernen. Leitung an der markierten Stelle (2) durchschneiden.



12-V-Batterie abklemmen

1. Abdeckung der 12-Volt-Batterie entfernen.
2. Minuskabel der 12-Volt-Batterie an der Schraubverbindung lösen und gegen ungewollten Kontakt sichern.