













- | | | | | | | | | | |
|---|---|---|---------------------------|--|---|--|-------------------------|---|--|
|  | Airbag |  | Gerador de gás |  | Pré-tensor do cinto de segurança |  | Unidade de controlo SRS |  | Sistema de proteção de pedestres ativo |
|  | Mola de pressão a gás/mola pré-tensionada |  | Bateria de baixa voltagem |  | Diesel reservatório de combustível |  | Bateria de alta tensão |  | Cabo de alimentação de alta tensão |
|  | Componente de alta tensão |  | Corte de cabo |  | Dispositivo de baixa tensão que desconecta o sistema de alta tensão | | | | |

Indicação: Para mais informações, por favor consulte o nosso [guia de salvamento](#).



1. Identificação / reconhecimento

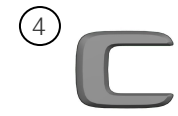
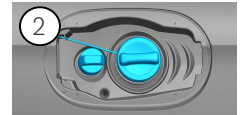
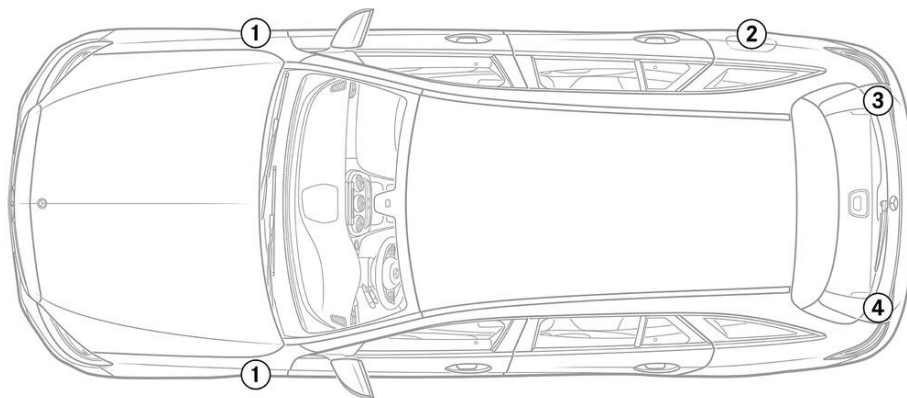

3. Neutralização dos principais perigos / regras de segurança

Desativação do sistema de alta voltagem

Em todos os outros casos, desativar o sistema de alta voltagem da seguinte forma:

Opção 1: Dispositivo de desconexão de alta voltagem

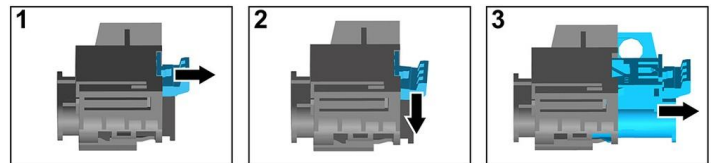
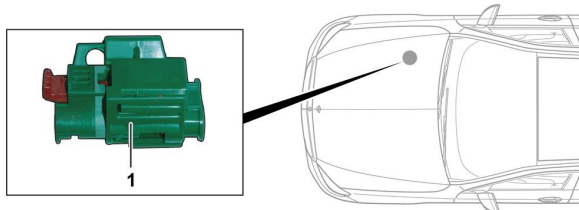

O dispositivo de desconexão de alta voltagem encontra-se no compartimento do motor no lado do acompanhante.



- (1) Puxar o desbloqueio
- (2) Pressionar o desbloqueio para baixo
- (3) Remover o interruptor

Opção 2: Dispositivo de desconexão de alta voltagem alternativo



O dispositivo de desconexão de alta voltagem alternativo encontra-se por baixo da cobertura da caixa de fusíveis no cockpit no lado do condutor. É assinalado com um sinal.

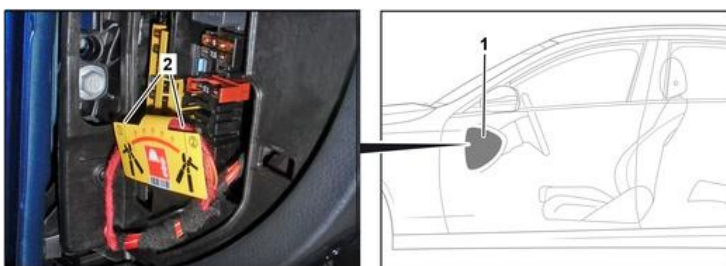

Retirar a cobertura (1). Cortar o cabo no lugar marcado (2).



Desconectar a bateria de 12 V

1. Retirar a cobertura das baterias de 12 volts.
2. Soltar o cabo negativo da bateria de 12 volts na união roscada e proteger contra contacto involuntário.