







- | | | | | |
|---|--|--|--|---|
|  Airbag |  Generatore di gas |  Pretensionatore delle cinture di sicurezza |  Scheda elettronica SRS |  Ammortizzatore pneumatico / molla precaricata |
|  Batteria a basso voltaggio |  Benzina serbatoio del carburante | | | |

Nota: Ulteriori informazioni sono disponibili nelle nostre linee guida per il soccorso [linee guida per il soccorso](#)



1. Identificazione / riconoscimento



2. Immobilizzazione / stabilizzazione / sollevamento

Freno di parcheggio

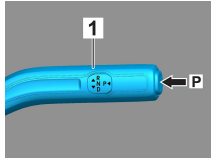

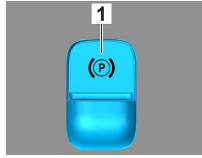
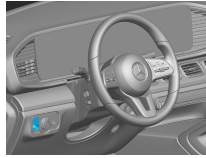

Freno di stazionamento

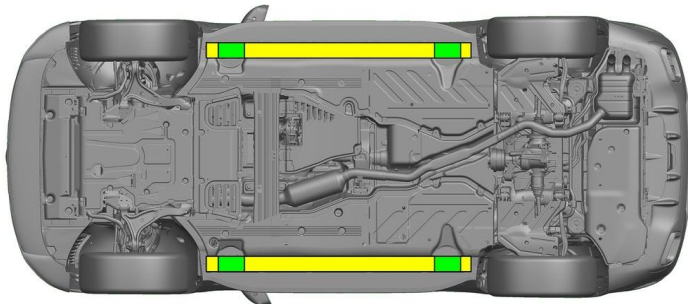

Premere il pulsante P sulla leva di selezione (1). Il freno di stazionamento elettrico (1) viene attivato automaticamente.



-  Adeguati punti di sollevamento
-  Adeguati punti di stabilizzazione sul lato



Evitare un'ulteriore deformazione della pedana e del sottoscocca durante il salvataggio (ad es. sollevamento con equipaggiamento idraulico).



3. Disattivazione dei pericoli diretti / Regolamenti di Sicurezza

Disinserire l'accensione:

1. Premere il tasto START-STOP senza azionare il freno di esercizio.
2. Tenere la chiave elettronica del veicolo a distanza di almeno 5 m.

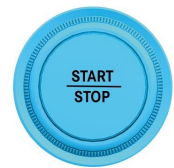
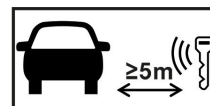

L'assenza di rumori dal motore non significa che il veicolo sia spento.



Un riavvio è possibile solo fino alla messa fuori servizio del veicolo.



Scollegare la batteria a 12/48 V

1. Rimuovere il coperchio della batteria a 12/48 Volt.
2. Scollegare il cavo negativo della batteria a 12/48 Volt nel raccordo a vite e metterlo in sicurezza contro un involontario contatto.



I sistemi di sicurezza passivi (airbag e pretensionatori delle cinture di sicurezza) vengono disattivati.

4. Accesso agli occupanti

Nell'ambito della liberazione degli occupanti si deve tenere conto dei componenti dei sistemi di ritenuta (in particolare degli elementi pirotecnici) conformemente alle indicazioni fornite a pagina 1.

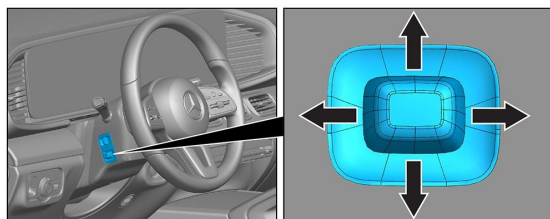

Regolazione del volante

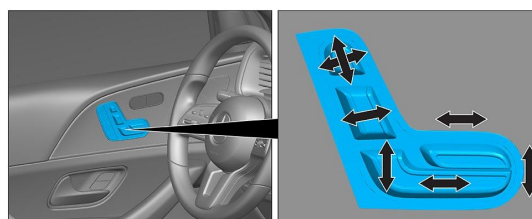

Regolazione (elettrica) del sedile

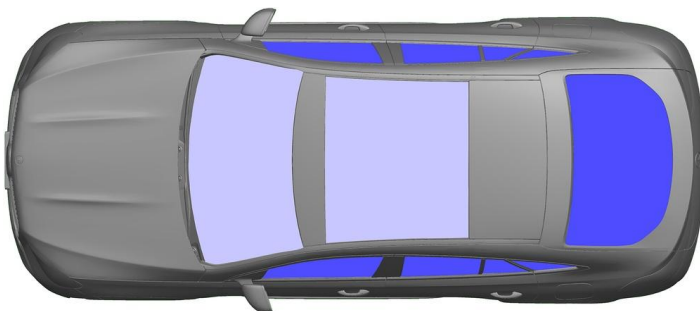

VSG: Verbundsicherheitsglas, vetro stratificato di sicurezza

ESG: vetro di sicurezza monostrato

5. Immagazzinamento energia / liquidi / gas / solidi



6. In caso d'incendio



Per estinguere l'incendio di un veicolo utilizzare grandi quantità di acqua (H₂O).

7. In caso di immersione

Non sussiste il pericolo di tensione sulla carrozzeria. Dopo il recupero del veicolo:

1. Fare defluire l'acqua dall'abitacolo.
2. Avviare la disattivazione della rete di bordo a 12/48 V (vedere il capitolo 3).



8. Traino / trasporto / stazionamento

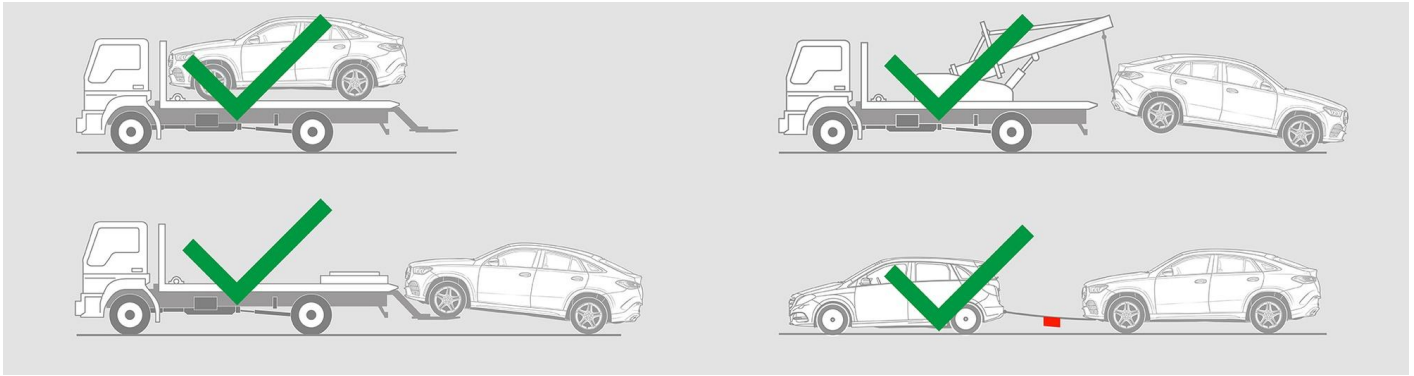

9. Informazioni aggiuntive importanti

Ulteriori informazioni sono riportate nelle [Linee guida per i servizi di traino Autovetture](#).

10. Spiegazione dei pittogrammi utilizzati



Veicolo con carburante del gruppo liquido 2



Attenzione pericolo generico



Infiammabile



Pericoloso per la salute umana



Corrosivi



Tossicità acuta



Utilizzare l'acqua per spegnere l'incendio



Utilizzare schiuma a secco per spegnere l'incendio



Utilizzare schiuma bagnata per spegnere l'incendio



Rimozione chiave intelligente