









- ① 12 V 蓄电池
- ② 高压蓄电池
- ③ 高压充电插座
- ④ 板载充电器
- ⑤ 12 V 附加蓄电池

 气囊	 气体发生器	 安全带紧急拉紧器	 气压减震器	 油箱
 乘员保护系统控制单元	 12 V 蓄电池	 高压蓄电池	 高压组件	 高压断路装置
 备用高压断路装置				

提示: 详细信息请参见[救援指南](#)。



### 1. 确认/识别

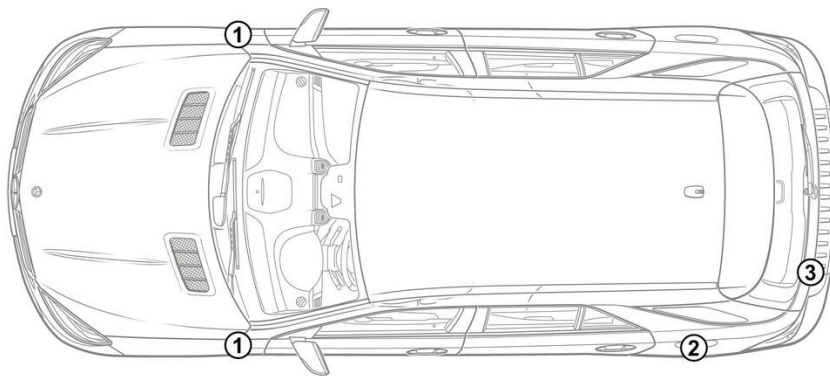

### 3. 消除威胁/安全规章

#### 停用高压系统

而在其他情况下，如下停用高压系统：

#### 选项 1: 高压断开装置

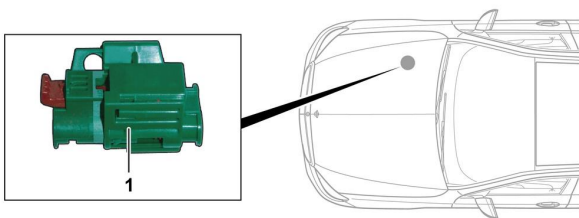

高压断开装置位于 副驾驶侧的发动机舱内。

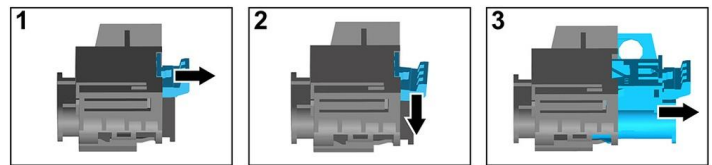

- (1) 拉动解锁装置
- (2) 向下按下解锁装置
- (3) 拉出开关



#### 选项 2: 备用高压断开装置

备用高压断开装置位于驾驶员侧驾驶舱的保险丝盒盖板下方。  
备用高压断开装置用指示牌标记。

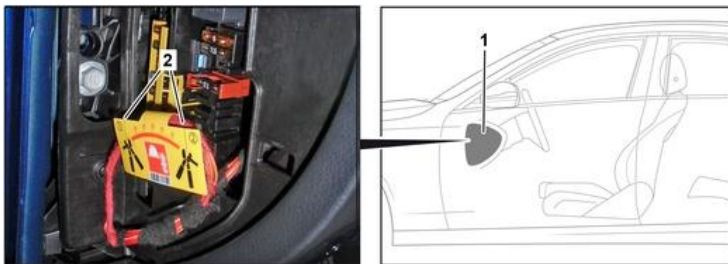

取掉盖板 (1)。在标记点 (2) 处切断电线。



#### 断开 12V 电池连接

1. 取掉 12V 电池的盖板
2. 松开螺栓连接上 12V 电池的负极电缆，并将其固定好，防止无意接触。

