

- Kollisjonspute
- Gassgenerator
- Beltestrammer
- SRS styreenhet
- Aktivt fotgjengerbeskyttelsessystem
- Gasstrykkdemper / Forspent fjær
- Lavvolt-batteri
- Bensin drivstofftank

Merknad: Mer informasjon finner du i vår [bergingsveiledning](#).



1. Identifisering / Gjenkjenning



CLA 200

2. Immobilisering / stabilisering / løfting

Parkeringsbrems

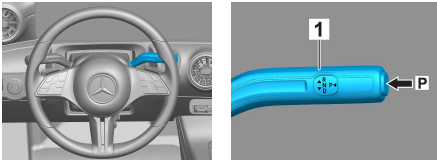

Trykk på bryter P på girvelgeren (1).
Parkeringsbremsen aktiveres automatisk.

Håndbrems



Elektrisk håndbrems (1)

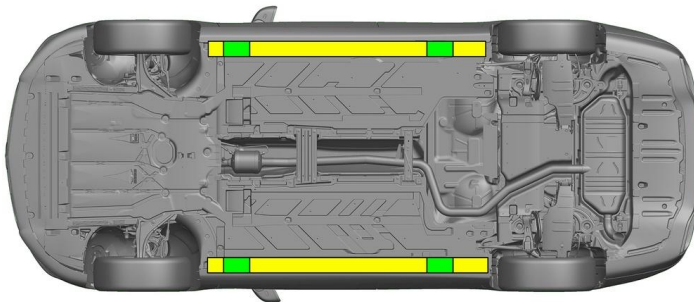

- Eget løftepunkt
- Eget stabilisering på siden



En ekstra misforming av travers og underrammen må unngås under bergingen (f.eks. gjennom å støtte med hydraulikkutstyr).

3. Deaktivere direkte farer / sikkerhets regler

Slå tenningen av:

1. Trykk på START-STOPP-knappen, uten å aktivere motorbremsen.
2. Oppbevar den elektroniske bilnøkkelen i en avstand på minst 5 m.



Selv om du ikke kan høre om motoren går, betyr ikke dette at bilen er slått av.



Bilen kan starte på nytt, helt til den settes ut av drift.



Klem av 12/48-V-batteriet

1. Fjern dekselet på 12/48-V-batteriet.
2. Løsne skruforbindelsen på minuskabelen til 12/48-V-batteriet, og sikre mot utilsiktet kontakt.



De passive sikkerhetssystemene (airbagger og beltestrammere) deaktiveres.



4. Tilgang til fører/passasjerer

Under redningen av personene i bilen skal man ta hensyn til komponentene til passasjersikringssystemet (spesielt pyrotekniske elementer) i henhold til opplysningene på side 1.



Rattinnstilling





Seteinntilling (mekanisk)



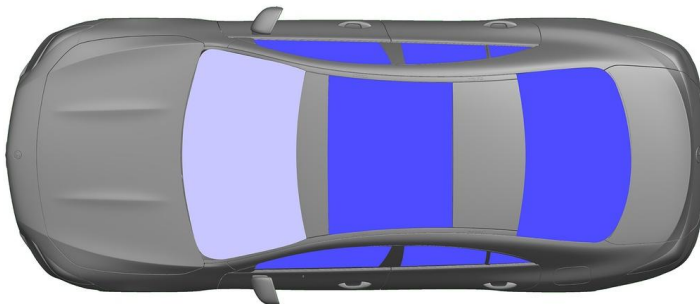











Seteinntilling (elektrisk)



 VSG: Laminert sikkerhetsglass

 ESG: Herdet sikkerhetsglass

5. Lagret energi / væske / gass / fast

	    	12/48V
	 	43
	  	590 ± 10g

6. I tilfelle brann



Bruk store mengder vann (H₂O) når du slukker en bilbrann.

7. I tilfelle nedsenket i vann/sjø

Det foreligger ikke fare for at spenningen går over på karosseriet. Etter at bilen er berget:

1. Slipp ut vannet fra bilens innside.
2. Begynn med å deaktivere 12-V/48-V-ledningsnett (se kapittel 3).



8. Tauing / transport / lagring

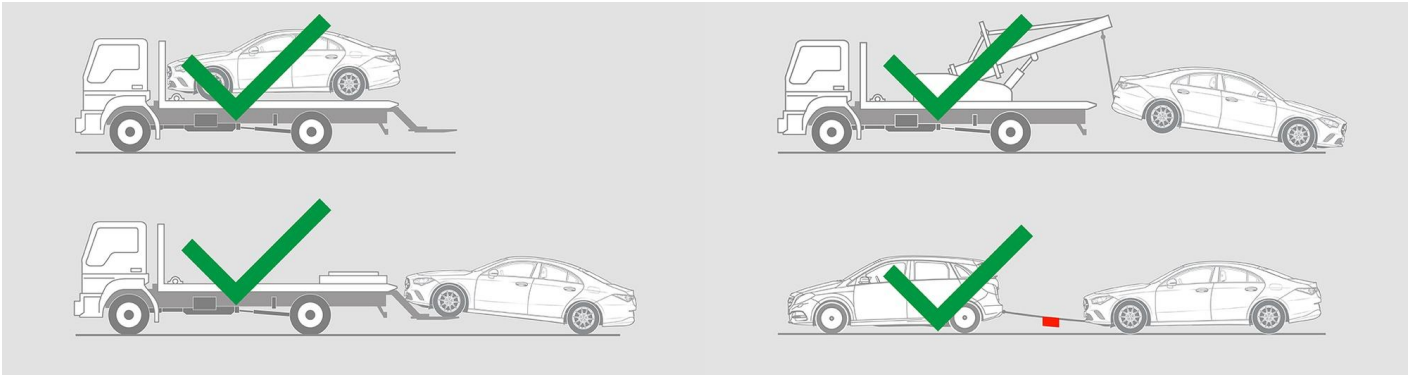

9. Viktig ekstra informasjon

Mer informasjon finner du i [Veiledning for slepetjenester for sleping av personbil](#).

10. Forklaring av piktogrammer

-  Kjøretøy med flytende drivstoff kl. 2
-  Fare
-  Brennbar
-  Helsefarlig
-  Korroderende
-  Akutt toksisitet
-  Eksplosiv
-  Slukke med vann
-  Slukkes med tørt skum
-  Slukkes med vått skum
-  Fjern smartnøkkel
-  Air-conditioning component
-  Warning; low temperature