









-  Airbag
-  Gas generator
-  Seat belt pretensioner
-  SRS control unit
-  Active pedestrian protection system
-  Gas strut / Pre-loaded spring
-  Low-voltage battery
-  Diesel Fuel tank

Note: Please see our [emergency response guide](#) for more information



1. Identification / recognition



2  
CLA 200d

2. Immobilisation / stabilisation / lifting

Parking brake

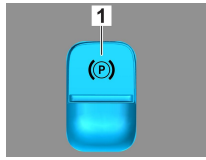
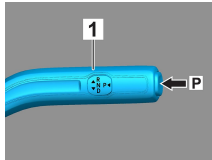

Press the P switch on the gear selector (1). The parking brake is automatically activated.

Electric parking brake (1)

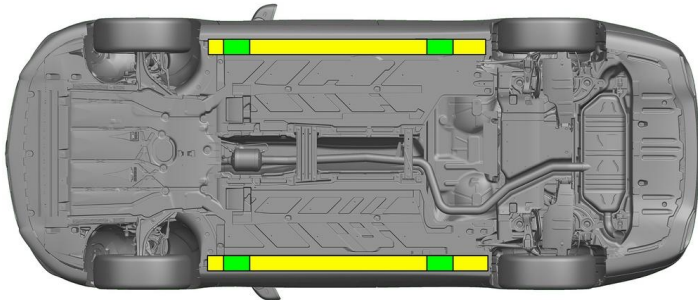

- Suitable lifting points
- Suitable stabilisation points on the side

Additional deformation of the door sills and the underbody (e.g. through support with hydraulic equipment) must be avoided during the rescue.

3. Disable direct hazards / safety regulations

Switch off the ignition:

1. Press the START/STOP button without actuating the service brake.
2. Keep the electronic vehicle key at a distance of at least 5 m.

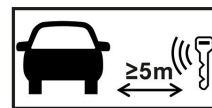

The absence of engine noise does not mean that the vehicle is switched off.

A restart is possible until the vehicle is switched off.



Disconnecting the 12 V battery

1. Remove the cover from the 12-volt battery.
2. Disconnect the negative cable of the 12-volt battery at the screw connection and secure it against unintentional contact.

The passive safety systems (airbags and seat belt pretensioners) are deactivated.



### 4. Access to the occupants

When rescuing the vehicle occupants, the components of the restraint systems (in particular pyrotechnic elements) must be taken into account in accordance with the information on page 1.



Steering wheel adjustment



Seat adjustment (mechanical)



Seat adjustment (electric)



 VSG: Laminated safety glass

 ESG: Tempered glass

### 5. Stored energy / liquids / gases / solids



### 6. In case of fire



Use large volumes of water (H<sub>2</sub>O) to extinguish a vehicle fire.

### 7. In case of submersion

There is no risk of voltage in the bodywork. After recovery of the vehicle:

1. Allow the water to drain out of the interior.
2. Commence deactivation of the 12 V/48 V electrical system (see Section 3).

### 8. Towing / transportation / storage

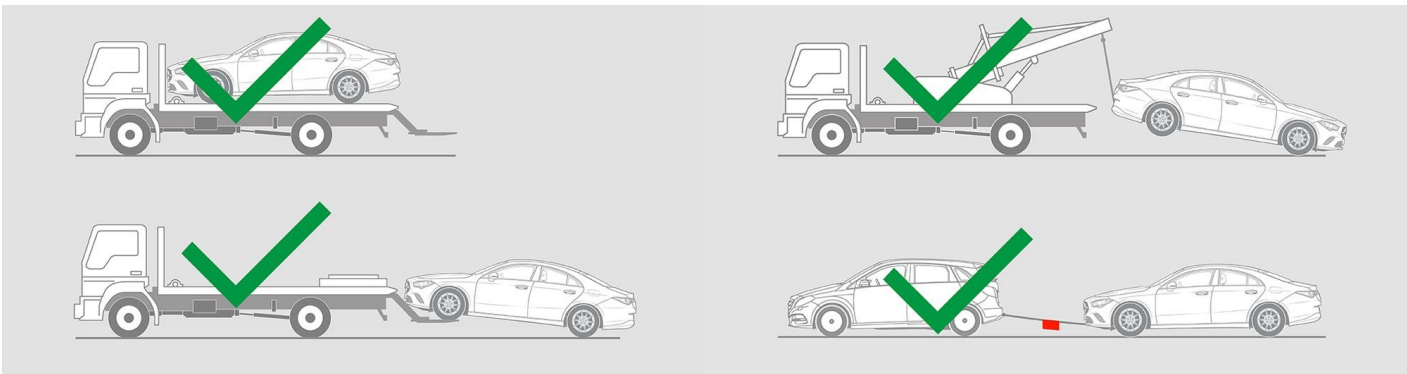



## 9. Important additional information

You can find more information in the [Guidelines for car towing services](#).

## 10. Explanation of pictograms used



Vehicle on fuel of liquid group 1



General warning sign



Flammable



Hazardous to the human health



Corrosives



Acute toxicity



Use water to extinguish the fire



Use dry foam to extinguish the fire



Use wet foam to extinguish the fire



Bonnet



Remove smart key