

-  气囊
-  气体发生器
-  安全带预紧器
-  SRS 控制单元
-  主动行人保护系统
-  气体压力缓冲器/预压紧的弹簧
-  低电压蓄电池
-  柴油 燃料罐

提示: 详细信息请参见[救援指南](#)。



1. 确认/识别



2. 固定/稳定/抬升

手刹

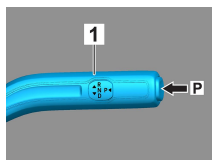
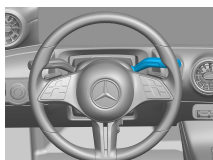

驻车制动器

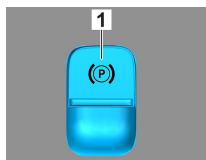

按下换挡杆 (1) 上的开关 P。自动激活手刹。

电动驻车制动器 (1)

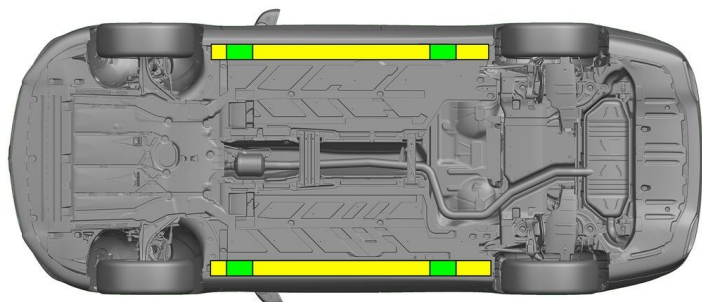

适当的提升点

侧面上适当的稳定点



救援期间必须避免车门门槛结构和车身底板发生额外的变形（例如用千斤顶撑住）。

3. 消除威胁/安全规章

关闭点火装置：

1. 按下启停按钮，而不要操作行车制动器。
2. 将电子车钥匙放在至少 5 米以外。

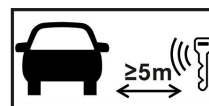

发动机没有发出声音，并不意味着车辆就已经熄火了。



在车辆熄火之前均可重启。



断开 12V 电池连接

1. 取掉 12V 电池的盖板
2. 松开螺栓连接上 12V 电池的负极电缆，并将其固定好，防止无意接触。



停用无源安全系统（安全气囊和安全带拉紧器）。



4. 救援通道搭建

解救车辆驾驶员及乘客时应根据第1页上的说明考虑到约束系统的部件（尤其是爆燃元件）。

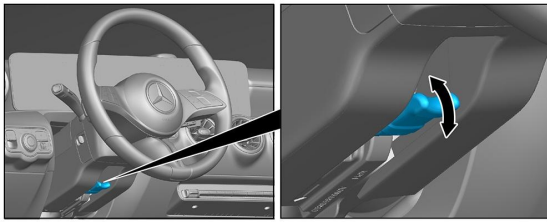

方向盘调节

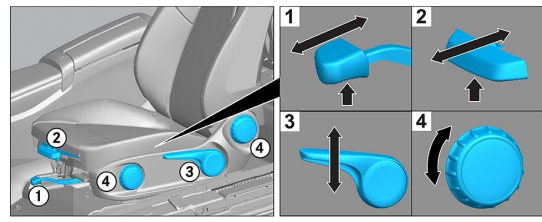

座椅调节（机械）

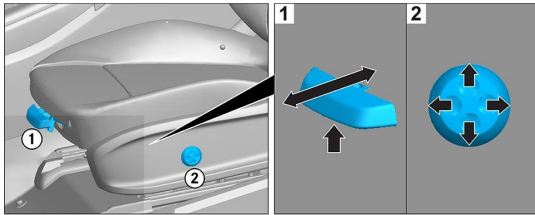

座椅调节（电动）

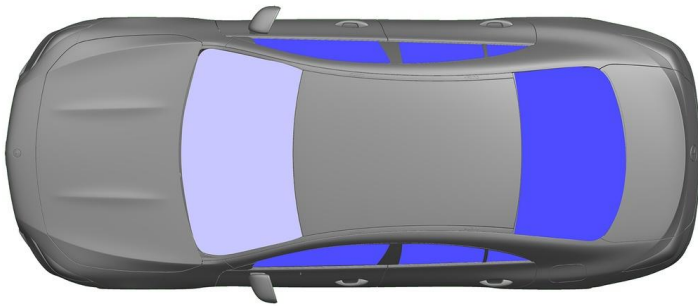

 VSG：夹层安全玻璃

 ESG：单层安全玻璃

5. 剩余电量 / 液化气 / 燃油 / 固体燃料



6. 车辆起火



使用大量的水 (H₂O) 灭火。

7. 车辆淹没

没有车身通电的危险。打捞车辆后：

1. 把水从汽车内室中排出。
2. 停用 12V/48V 车载电气系统（参见第3章）。

8. 牵引 / 转移 / 存放

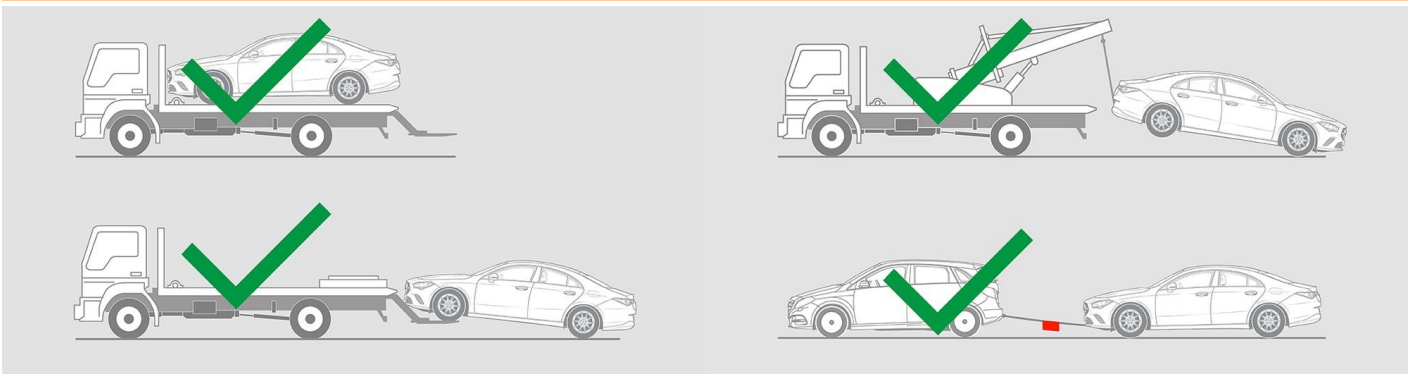



9. 其他重要信息

更多信息请查看 [乘用车拖车服务指南](#)。

10. 使用图示的释义



使用第1组液体燃料的汽车



一般警告标志



易燃



对人体健康有害



腐蚀性物质



急性毒性



用水灭火



用干泡沫灭火



用湿泡沫灭火



发动机罩



移除智能钥匙